

Athletic Connection

TEAM SPORTS - STRENGTH & FITNESS - FACILITIES - P.E.





RAZOR

Line of Distinction...

More than a decade after the revolutionary Z-Cool® shoulder pads were introduced, evolution has continued with GEAR PRO-TEC's new RAZOR™ shoulder pads. Pushing the limits of shoulder pad design, every detail is focused on elite player performance. Cutting edge design, materials and construction culminate in advanced impact dispersion, dynamic range of motion and flexibility on the lightest weight platform in the industry. **RAZOR is the pinnacle of success in protecting America's finest athletes for over 20 years!**

GEAR
PRO-TEC

BRANDS YOU DEMAND



TEAM SPORTS

- BENCHES 4-5
- BLEACHERS 6-15
- BASEBALL/SOFTBALL 16-91
- BASKETBALL 92-117
- FOOTBALL 118-151
- HYDRATION 152-157
- LACROSSE 158-159
- FIELD HOCKEY 160-161
- SOCCER 162-181
- RACQUET SPORTS 182-197
- TRACK & FIELD 198-215
- VOLLEYBALL 216-230
- WRESTLING 231-233

STRENGTH & FITNESS

- WEIGHT LIFTING 234-245
- FLOORING 246-247
- CARDIO 248-251
- CORE 252-265
- SPEED & AGILITY 266-270
- ASSESSMENT 271-277
- MATS/GYMNASTICS 278-284
- BOXING 285-287

FACILITY

- COACHING 288-291
- CONCESSIONS 292-293
- FIELD MARKING 294-297
- FLOOR COVERS 298-299
- GAME TABLES 300-309
- LOCKS & LOCKERS 310-311
- PARKS 312-315
- SCOREBOARDS 316-327
- SPORTS MED 328-332
- TRAFFIC SAFETY 333
- STORAGE 334-337
- WALL PADS 338-340

PHYSICAL EDUCATION

- PHYSICAL EDUCATION 341-357
- ARCHERY 358

INDEX 359-363



PLAYER'S BENCH WITH SHELF

- Finally, players and coaches have a place for equipment
- Features 10"W anodized or powder coated planks
- 20"W rear shelf
- All aluminum construction.
- Portable or surface mount (requires drilling holes in framework)

5 Year Limited Warranty

ANODIZED ALUMINUM		
LENGTH	CODE	PRICE
7.5'	BEPS08	\$569 ⁹⁹ ★
15'	BEPS15	\$789 ⁹⁹ ★
21'	BEPS21	\$1,029 ⁹⁹ ★
27'	BEPS27	\$1,559 ⁹⁹ ★
POWDER-COATED (SELECT COLOR)		
7.5'	BEPS08C	\$619 ⁹⁹ ★
15'	BEPS15C	\$969 ⁹⁹ ★
21'	BEPS21C	\$1,379 ⁹⁹ ★



Shelf space allows place for helmets, scorebooks, caps, water bottles, gloves, etc.



SCORERS TABLE WITH BENCH

- Table and bench are 7.5' L
- All aluminum construction
- Features 10"W anodized or powder coated aluminum seat planks
- 20"W ribbed aluminum table top.
- If choosing powder coated, specify color: Forest Green, Navy Blue, Red, Royal Blue

5 Year Limited Warranty

	Natural Aluminum	Price
BEST08	Natural Aluminum	\$519 ⁹⁹ EA ★
BEST08C	Powder Coated	\$569 ⁹⁹ EA ★

ALUMINUM

NAVY BLUE

SCARLET RED

ROYAL BLUE



SAFETY END CAPS

- UV treated poly endcaps
- No Sharp edges
- Designed to fit BSN Sports planks only
- Sold in pack of 6
- Hardware included

BEENDCAP \$9⁹⁹ PACK ★



GYM FLOOR PROTECTOR KIT

- Non-marring floor protectors
- Fit any 2 3/8" O.D. material

5 Year Limited Warranty

BEPROT8	7 1/2' Bench kit	\$19 ⁹⁹ KIT OF 4
BEPROT15	15' Bench kit	\$28 ⁹⁹ KIT OF 6
BEPROT21	21' Bench kit	\$36 ⁹⁹ KIT OF 8

ADD COLOR TO YOUR BENCHES!
 NJ State Approved Co-op #65MCE SCCPS Metuchen/Garden State AppareBid Term: 5/9/18 - 5/8/20; Extended to 5/8/21
 SPECIFY COLOR WHEN ORDERING

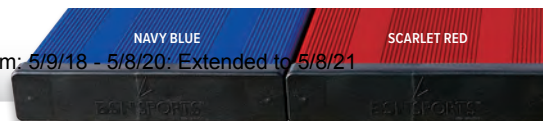

Bid #ESCNJ 17/18-31

Educational Services Commission of New Jersey

Athletic Equipment & Supplies

PLAYER'S BENCH WITH BACK

THE BEST PLAYER'S BENCHES AVAILABLE...GUARANTEED!

- Seat planks are 10" wide with a ribbed no-slip surface.
- Planks are anodized aluminum and will not rub off on clothing
- Comes with Safety End Caps - No sharp edges to snag clothing or skin
- Legs are constructed of heavy duty commercial grade 2-3/8" O.D. galvanized steel
- Portable models are designed for indoor and outdoor use and come complete with non-marring floor protectors



5 Year Limited Warranty

ANODIZED ALUMINUM				
	IN-GROUND	PORTABLE	SURFACE-MOUNT	
LENGTH	CODE	CODE	CODE	PRICE
7.5'	BEPB08	BEPG08	BEPH08	\$399 ⁹⁹ ★
15'	BEPB15	BEPG15	BEPH15	\$579 ⁹⁹ ★
21'	BEPB21	BEPG21	BEPH21	\$724 ⁹⁹ ★
27'	BEPB27	BEPG27	BEPH27	\$789 ⁹⁹ ★
POWDER-COATED (SELECT COLOR)				
LENGTH	CODE	CODE	CODE	PRICE
7.5'	BEPB08C	BEPG08C	BEPH08C	\$469 ⁹⁹ ★
15'	BEPB15C	BEPG15C	BEPH15C	\$729 ⁹⁹ ★
21'	BEPB21C	BEPG21C	BEPH21C	\$839 ⁹⁹ ★

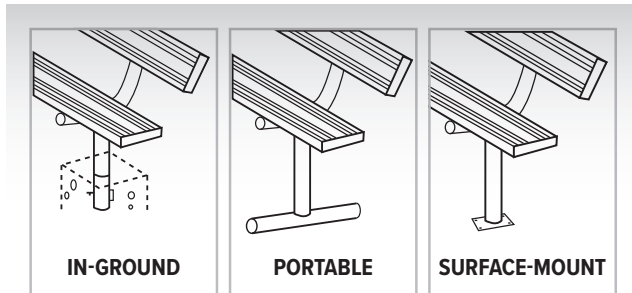

PLAYER'S BENCH WITHOUT BACK

- Same features as listed above - simply sold without the back rest
- 5 Year Limited Warranty



ANODIZED ALUMINUM				
	IN-GROUND	PORTABLE	SURFACE-MOUNT	
LENGTH	CODE	CODE	CODE	PRICE
7.5'	BEPD08	BEP108	BEPE08	\$309 ⁹⁹ ★
15'	BEPD15	BEP115	BEPE15	\$369 ⁹⁹ ★
21'	BEPD21	BEP121	BEPE21	\$489 ⁹⁹ ★
27'	BEPD27	N/A	BEPE27	\$549 ⁹⁹ ★
POWDER-COATED (SELECT COLOR)				
LENGTH	CODE	CODE	CODE	PRICE
7.5'	BEPD08C	BEP108C	BEPE08C	\$369 ⁹⁹ ★
15'	BEPD15C	BEP115C	BEPE15C	\$429 ⁹⁹ ★
21'	BEPD21C	BEP121C	BEPE21C	\$539 ⁹⁹ ★



CALL FOR DISCOUNTED PRICING ON BULK ORDERS

NJ State Approved Co-op #65MCESSCCPS Metuchen/Garden State Apparel Bid Term: 5/9/18 - 5/8/20, Extended to 5/8/21

BENCHES



PREFERRED, 15' FOREST GREEN

NOTE: Bleachers are shipped knocked down.

LOW RISE BLEACHERS

- Specially designed frames that allows 4 rows of seating without the need for safety fencing.
- Frames are 100% welded aluminum angle
- First row has a seat height of 12"
- Top row has a seat height of 29"
- Seat planks are anodized aluminum or powder coated and won't rub off on clothes!
- Standard models include single foot planks
- Preferred models include double foot planks
- Due to constantly changing specifications, Please check local building and safety codes to ensure bleacher compliance.

5 Year Limited Warranty



STANDARD - Single Foot Planks

PREFERRED - Double Foot Planks

ANODIZED ALUMINUM

ROWS	LXHXD	SEATS	STANDARD	PREFERRED	STANDARD	PRICE	PREFERRED	PRICE
4	7.5'x30"x81"	20	155 lbs	200 lbs	LR0408	\$1,239 ⁹⁹ ★	LR0408P	\$1,599 ⁹⁹ ★
4	15'x30"x81"	40	270 lbs	355 lbs	LR0415	\$1,869 ⁹⁹ ★	LR0415P	\$2,269 ⁹⁹ ★
4	21'x30"x81"	56	385 lbs	500 lbs	LR0421	\$2,319 ⁹⁹ ★	LR0421P	\$2,724 ⁹⁹ ★
4	27'x30"x81"	72	500 lbs	665 lbs	LR0427	\$2,669 ⁹⁹ ★	LR0427P	\$3,219 ⁹⁹ ★

POWDER-COATED (SELECT COLOR)

ROWS	LXHXD	SEATS	STANDARD	PREFERRED	STANDARD	PRICE	PREFERRED	PRICE
4	7.5'x30"x81"	20	155 lbs	200 lbs	LR0408C	\$1,279 ⁹⁹ ★	LR0408CP	\$1,744 ⁹⁹ ★
4	15'x30"x81"	40	270 lbs	355 lbs	LR0415C	\$1,959 ⁹⁹ ★	LR0415CP	\$2,469 ⁹⁹ ★
4	21'x30"x81"	56	385 lbs	500 lbs	LR0421C	\$2,449 ⁹⁹ ★	LR0421CP	\$2,959 ⁹⁹ ★

We build our benches & bleachers to the highest standards. Listed below are some of the differences by others who may be listing their benches & bleachers as comparable to ours.

1. Frames - Ours are 100% aluminum angle. Be careful of those quoting "galvanized, steel angle iron" as equal.
2. Seat Planks - Ours are 100% anodized aluminum with a minimum wall thickness of .078 in. A thinner walled unit does not have the strength or support.
3. End Caps - Ours are constructed of fiber reinforced polypropylene. No sharp edges to snag clothing or skin.

4. Indoor Use - Our Tip N' Roll units come with rubber leg protectors so they can be used indoors or out. Be careful of those units using steel vs aluminum. In a "tip-over" fashion, steel could damage your gym floor or cause personal injuries.

Don't be fooled by a low price. Our manufacturing team has been in this business for 30 years. If you see bids or quotes that "seem too good to be true" - they are. Respectable manufacturers purchase aluminum at the same prices. Anyone offering to deliver product at 30% less is not matching specs.

ADD COLOR TO YOUR BLEACHERS!

NJ State Approved Co-op #65MCECCPS Metuchen/Garden State AppareBid Term: 5/9/18 - 5/8/20; Extended to 5/8/21

SPECIFY COLOR WHEN ORDERING

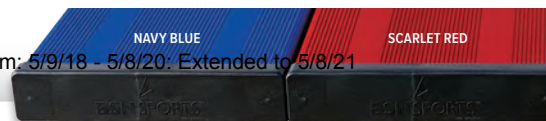



NOTE: Bleachers are shipped knocked down.

STANDARD 3 ROW, 15' ANODIZED ALUMINUM



PREFERRED 2 ROW, 15' ROYAL BLUE



PREFERRED 3 ROW, 15' SCARLET

BLEACHERS WITHOUT FENCING

- Frames are 100% welded aluminum angle
- First row has a seat height of 18"
- Top row has a seat height of 29"
- Planks are 10"W
- Due to constantly changing specifications, please check local building and safety codes to ensure bleacher compliance
- Standard models include single foot planks
- Preferred models include double foot planks

5 Year Limited Warranty



STANDARD - Single Foot Planks



PREFERRED - Double Foot Planks

ANODIZED ALUMINUM									
ROWS	LXHXD	SEATS	STANDARD	PREFERRED	STANDARD	PRICE	PREFERRED	PRICE	
2	15'x24"x36"	20	126 lbs	157 lbs	NB0215	\$1,014 ⁹⁹ ★	NB0215P	\$1,149 ⁹⁹ ★	
2	21'x24"x36"	28	170 lbs	213 lbs	NB0221	\$1,329 ⁹⁹ ★	NB0221P	\$1,464 ⁹⁹ ★	
3	15'x30"x60"	30	203 lbs	263 lbs	NB0315	\$1,369 ⁹⁹ ★	NB0315P	\$1,509 ⁹⁹ ★	
3	21'x30"x60"	42	280 lbs	360 lbs	NB0321	\$1,644 ⁹⁹ ★	NB0321P	\$1,869 ⁹⁹ ★	
3	27'x30"x60"	54	367 lbs	476 lbs	NB0327	\$2,099 ⁹⁹ ★	NB0327P	\$2,399 ⁹⁹ ★	
POWDER-COATED (SELECT COLOR)									
ROWS	LXHXD	SEATS	STANDARD	PREFERRED	STANDARD	PRICE	PREFERRED	PRICE	
2	15'x24"x36"	20	126 lbs	157 lbs	NB0215C	\$1,269 ⁹⁹ ★	NB0215CP	\$1,439 ⁹⁹ ★	
2	21'x24"x36"	28	170 lbs	213 lbs	NB0221C	\$1,419 ⁹⁹ ★	NB0221CP	\$1,554 ⁹⁹ ★	
3	15'x30"x60"	30	203 lbs	263 lbs	NB0315C	\$1,464 ⁹⁹ ★	NB0315CP	\$1,599 ⁹⁹ ★	
3	21'x30"x60"	42	280 lbs	360 lbs	NB0321C	\$1,769 ⁹⁹ ★	NB0321CP	\$2,049 ⁹⁹ ★	



CALL FOR DISCOUNTED PRICING ON BULK ORDERS

NJ State Approved Co-op #65MCESCCPS Metuchen/Garden State Apparel Bid Term: 5/9/18 - 5/8/20, Extended to 5/8/21



STANDARD - Single Foot Planks



NOTE: Bleachers are shipped knocked down.

BLEACHERS WITH FENCING

- Frames are 100% welded aluminum angle
- Planks are 10" W
- Seat planks are anodized aluminum or powder coated and won't rub off on clothes
- Bleachers include guardrail system and riser boards on rows 4 and above
- Colored bleachers include colored seat planks only
- Planks include safety end caps - no sharp edges to snag clothes or skin
- Due to constantly changing specifications, please check local building and safety codes to ensure compliance

5 Year Limited Warranty



ANODIZED ALUMINUM

ROWS	LENGTH	SEATS	WEIGHT	CHAIN-LINK	PRICE	VERTICAL PICKET	PRICE
4	15'	40	596 lbs	NB0415	\$2,859 ⁹⁹ ★	NB0415V	\$3,484 ⁹⁹ ★
4	21'	56	777 lbs	NB0421	\$3,399 ⁹⁹ ★	NB0421V	\$4,349 ⁹⁹ ★
4	27'	72	970 lbs	NB0427	\$4,019 ⁹⁹ ★	NB0427V	\$5,319 ⁹⁹ ★
5	15'	50	749 lbs	NB0515	\$3,529 ⁹⁹ ★	NB0515V	\$4,209 ⁹⁹ ★
5	21'	70	992 lbs	NB0521	\$4,439 ⁹⁹ ★	NB0521V	\$5,299 ⁹⁹ ★
5	27'	90	1250 lbs	NB0527	\$5,624 ⁹⁹ ★	NB0527V	\$6,524 ⁹⁹ ★

POWDER-COATED (SELECT COLOR)

ROWS	LENGTH	SEATS	WEIGHT	CHAIN-LINK	PRICE	VERTICAL PICKET	PRICE
4	15'	40	596 lbs	NB0415C	\$3,084 ⁹⁹ ★	NB0415CV	\$3,714 ⁹⁹ ★
4	21'	56	777 lbs	NB0421C	\$3,579 ⁹⁹ ★	NB0421CV	\$4,499 ⁹⁹ ★
5	15'	50	749 lbs	NB0515C	\$3,849 ⁹⁹ ★	NB0515CV	\$4,524 ⁹⁹ ★
5	21'	70	992 lbs	NB0521C	\$4,749 ⁹⁹ ★	NB0521CV	\$5,469 ⁹⁹ ★

ADD COLOR TO YOUR BLEACHERS!

NJ State Approved Co-op #65MCECCPS Metuchen/Garden State AppareBid Term: 5/9/18 - 5/8/20; Extended to 5/8/21

SPECIFY COLOR WHEN ORDERING

NAVY BLUE

SCARLET RED

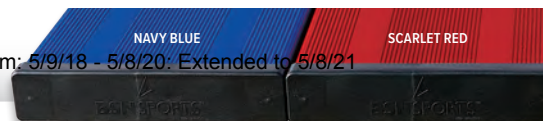



4 ROW, 15' SCARLET RED WITH VERTICAL PICKETS



PREFERRED - Double Foot Planks



NOTE: Bleachers are shipped knocked down.

PREFERRED BLEACHERS WITH FENCING

- Frames are 100% welded aluminum angle
- Seat planks are anodized or powder coated (where applicable)
- Bleachers include guardrail system and riser boards on rows 4 and above
- Chain-link fencing is 9 gauge steel
- Available in 4 & 5 row models
- Available in 15', 21' and 27' long
- Due to constantly changing specifications, please check local building and safety codes to ensure compliance.

5 Year Limited Warranty



ANODIZED ALUMINUM							
ROWS	LENGTH	SEATS	WEIGHT	CHAIN-LINK	PRICE	VERTICAL PICKET	PRICE
4	15'	40	616 lbs	NB0415P	\$3,129 ⁹⁹ ★	NB0415VP	\$3,804 ⁹⁹ ★
4	21'	56	820 lbs	NB0421P	\$3,759 ⁹⁹ ★	NB0421VP	\$5,019 ⁹⁹ ★
4	27'	72	1038 lbs	NB0427P	\$4,769 ⁹⁹ ★	NB0427VP	\$5,489 ⁹⁹ ★
5	15'	50	769 lbs	NB0515P	\$3,939 ⁹⁹ ★	NB0515VP	\$4,604 ⁹⁹ ★
5	21'	70	1032 lbs	NB0521P	\$5,019 ⁹⁹ ★	NB0521VP	\$5,784 ⁹⁹ ★
5	27'	90	1316 lbs	NB0527P	\$6,159 ⁹⁹ ★	NB0527VP	\$7,159 ⁹⁹ ★
POWDER-COATED (SELECT COLOR)							
ROWS	LENGTH	SEATS	WEIGHT	CHAIN-LINK	PRICE	VERTICAL PICKET	PRICE
4	15'	40	616 lbs	NB0415CP	\$3,479 ⁹⁹ ★	NB0415CVP	\$4,504 ⁹⁹ ★
4	21'	56	820 lbs	NB0421CP	\$3,939 ⁹⁹ ★	NB0421CVP	\$4,779 ⁹⁹ ★
5	15'	50	769 lbs	NB0515CP	\$4,209 ⁹⁹ ★	NB0515CVP	\$4,884 ⁹⁹ ★
5	21'	70	1032 lbs	NB0521CP	\$5,244 ⁹⁹ ★	NB0521CVP	\$6,019 ⁹⁹ ★



CALL FOR DISCOUNTED PRICING ON BULK ORDERS

NJ State Approved Co-op #65MCESSCCPS Metuchen/Garden State Apparel Bid Term: 5/9/18 - 5/8/20, Extended to 5/8/21



TIP N' ROLL BLEACHERS

- Tip N' Roll bleachers are perfect for auxiliary seating requirements
- Unit easily tips up on its casters for convenient storage
- Frames are 100% welded aluminum angle
- Seat planks are either anodized or powder coated (where applicable)
- High grade swivel casters & rubber foot pads will not mar your floors
- Due to constantly changing specifications, please check local building and safety codes to ensure compliance
- Standard models include single foot planks
- Preferred models include double foot planks
- WARNING: These lightweight units are easily tipped up for rolling by any responsible adult. However, if tipped up outdoors, extreme caution should be taken in windy conditions. Multiple adults may be required to control the unit

5 Year Limited Warranty



STANDARD - Single Foot Planks



PREFERRED - Double Foot Planks

ANODIZED ALUMINUM

ROWS	LXHXD	SEATS	STANDARD	PREFERRED	STANDARD	PRICE	PREFERRED	PRICE
2	7.5'x24"x36"	10	72 lbs	89 lbs	TR0208	\$744 ⁹⁹ ★	TR0208P	\$884 ⁹⁹ ★
2	15'x24"x36"	20	131 lbs	162 lbs	TR0215	\$1,099 ⁹⁹ ★	TR0215P	\$1,239 ⁹⁹ ★
2	21'x24"x36"	28	175 lbs	219 lbs	TR0221	\$1,469 ⁹⁹ ★	TR0221P	\$1,644 ⁹⁹ ★
3	7.5'x30"x60"	15	116 lbs	133 lbs	TR0308	\$1,059 ⁹⁹ ★	TR0308P	\$1,149 ⁹⁹ ★
3	15'x30"x60"	30	207 lbs	252 lbs	TR0315	\$1,369 ⁹⁹ ★	TR0315P	\$1,599 ⁹⁹ ★
3	21'x30"x60"	42	265 lbs	345 lbs	TR0321	\$1,779 ⁹⁹ ★	TR0321P	\$2,099 ⁹⁹ ★
3	27'x30"x60"	54	352 lbs	N/A	TR0327	\$2,319 ⁹⁹ ★	N/A	N/A
4*	7.5'x30"x81"	20	146 lbs	190 lbs	TR0408	\$1,329 ⁹⁹ ★	TR0408P	\$1,689 ⁹⁹ ★
4*	15'x30"x81"	40	295 lbs	384 lbs	TR0415	\$1,959 ⁹⁹ ★	TR0415P	\$2,364 ⁹⁹ ★
4*	21'x30"x81"	56	398 lbs	524 lbs	TR0421	\$2,359 ⁹⁹ ★	TR0421P	\$2,819 ⁹⁹ ★

POWDER-COATED - SELECT YOUR COLOR

ROWS	LENGTH	SEATS	STANDARD	PREFERRED	STANDARD	PRICE	PREFERRED	PRICE
2	7.5'x24"x36"	10	72 lbs	89 lbs	TR0208C	\$819 ⁹⁹ ★	TR0208CP	\$915 ⁹⁹ ★
2	15'x24"x36"	20	131 lbs	162 lbs	TR0215C	\$1,149 ⁹⁹ ★	TR0215CP	\$1,329 ⁹⁹ ★
2	21'x24"x36"	28	175 lbs	219 lbs	TR0221C	\$1,554 ⁹⁹ ★	TR0221CP	\$1,779 ⁹⁹ ★
3	7.5'x30"x60"	15	116 lbs	133 lbs	TR0308C	\$1,149 ⁹⁹ ★	TR0308CP	\$1,284 ⁹⁹ ★
3	15'x30"x60"	30	207 lbs	252 lbs	TR0315C	\$1,499 ⁹⁹ ★	TR0315CP	\$1,729 ⁹⁹ ★
3	21'x30"x60"	42	265 lbs	345 lbs	TR0321C	\$1,914 ⁹⁹ ★	TR0321CP	\$2,229 ⁹⁹ ★
4*	7.5'x30"x81"	20	146 lbs	190 lbs	TR0408C	\$1,419 ⁹⁹ ★	TR0408CP	\$1,734 ⁹⁹ ★
4*	15'x30"x81"	40	295 lbs	384 lbs	TR0415C	\$2,049 ⁹⁹ ★	TR0415CP	\$2,464 ⁹⁹ ★
4*	21'x30"x81"	56	398 lbs	524 lbs	TR0421C	\$2,544 ⁹⁹ ★	TR0421CP	\$2,999 ⁹⁹ ★

*4 Row models feature low rise framework. See page 6 for full details.

ADD COLOR TO YOUR TIP N' ROLL BLEACHERS!
SPECIFY COLOR WHEN ORDERING



Bid #ESCNJ 17/18-31

Educational Services Commission of New Jersey

Athletic Equipment & Supplies

5 ROWS X 15" LONG WITH 2 HANDICAP

Shown with Vertical Picket Guardrail System

5 ROWS X 21' LONG WITH 4 HANDICAP

Shown with Vertical Picket Guardrail System

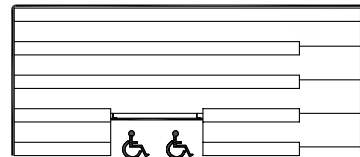
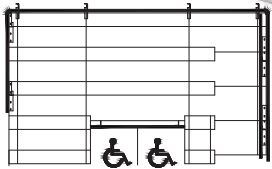
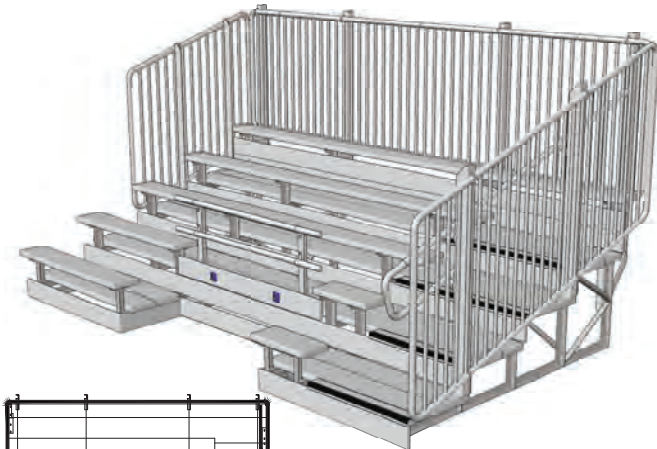

5 ROWS X 19'-6" LONG WITH 2 HANDICAP

Shown with Vertical Picket Guardrail System

5 ROWS X 27' LONG WITH 4 HANDICAP

Shown with Vertical Picket Guardrail System

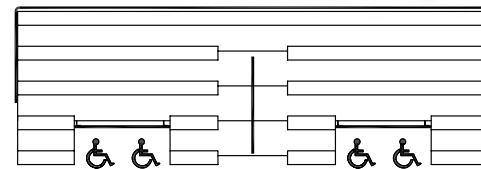
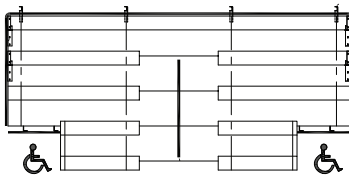
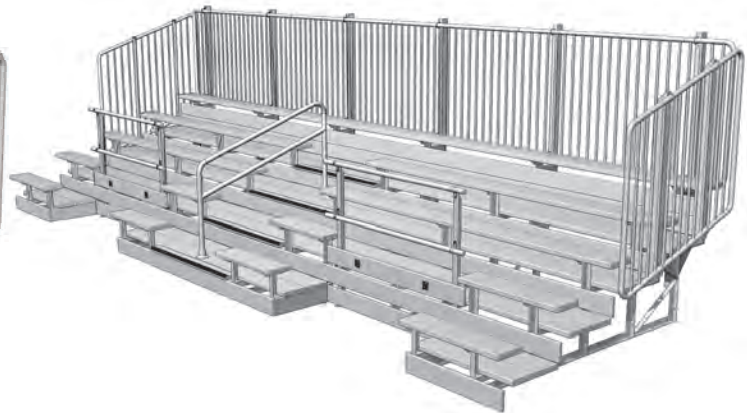
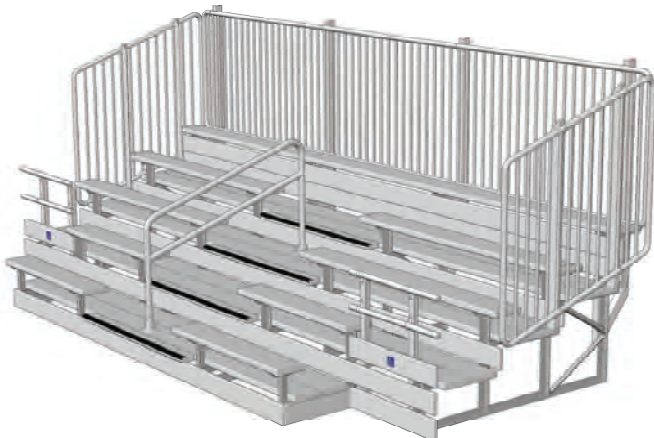

NOTE: Bleachers are shipped knockdown and require complete assembly on site.

DELUXE ADA BLEACHERS

- All aluminum deluxe ADA bleachers
- Single seat planks
- Double foot planks, riser closure on all rows and vertical aisle with handrails
- Choose between chain-link and vertical picket guardrails

ROWS	LENGTH	SEATS	WEIGHT	GUARD RAIL	CODE	PRICE	DELIVERY
5	15'	34 + 2 Handicap	1,050 lbs.	Chain-link	1383873	\$6,999 ⁹⁹ ★	
5	15'	34 + 2 Handicap	1,111 lbs.	Vertical Picket	1383874	\$7,949 ⁹⁹ ★	
5	19'-6"	45 + 2 Handicap	1,305 lbs.	Chain-link	1383875	\$8,124 ⁹⁹ ★	
5	19'-6"	45 + 2 Handicap	1,353 lbs.	Vertical Picket	1383876	\$8,979 ⁹⁹ ★	
5	21'	48 + 2 Handicap	1,404 lbs.	Chain-link	1301045	\$7,989 ⁹⁹ ★	
5	21'	48 + 2 Handicap	1,455 lbs.	Vertical Picket	1301052	\$9,249 ⁹⁹ ★	
5	27'	58 + 4 Handicap	1,854 lbs.	Chain-link	1301069	\$10,174 ⁹⁹ ★	
5	27'	58 + 4 Handicap	1,912 lbs.	Vertical Picket	1301076	\$11,309 ⁹⁹ ★	

NJ State Approved Co-op #65MCECCPS - Metuchen/Garden State Apparel Bid Term: 5/9/18 - 5/8/20: Extended to 5/8/21

BLEACHERS



PLEASE ALLOW 3 TO 4 WEEKS FOR DELIVERY.

VIP SERIES BLEACHERS

- Frames are 100% welded aluminum angle
 - 2" x 10" anodized aluminum seat planks
 - 2 - 2" x 10" foot planks on every row
 - 2" x 10" riser on top row and 1" x 6" risers on all other rows
 - 2" 9 gauge fence railing on all chain-link models
 - 4.5' aisle with aluminum hand rail on select models
- 5 Year Limited Warranty**

ROWS	LENGTH	SEATS	RAILING	AISLE	CHAIN-LINK	VERTICAL PICKET
5	21'	58	✓	✓	1049185 \$6,999 ⁹⁹	1196542 \$8,199 ⁹⁹
8	15'	80	✓		1135190 \$7,899 ⁹⁹	1196559 \$9,399 ⁹⁹
8	21'	112	✓		1135206 \$9,899 ⁹⁹	1196566 \$11,599 ⁹⁹
8	21'	91	✓	✓	1135220 \$11,099 ⁹⁹	1196580 \$12,699 ⁹⁹
8	27'	144	✓		1135213 \$12,199 ⁹⁹	1196573 \$14,099 ⁹⁹
8	27'	116	✓	✓	1135237 \$13,399 ⁹⁹	1196597 \$15,199 ⁹⁹
10	15'	100	✓		1135244 \$9,799 ⁹⁹	1196603 \$11,499 ⁹⁹
10	21'	140	✓		1135251 \$12,099 ⁹⁹	1196610 \$14,199 ⁹⁹
10	21'	113	✓	✓	1135275 \$13,799 ⁹⁹	1196634 \$15,599 ⁹⁹
10	27'	180	✓		1135268 \$15,399 ⁹⁹	1196627 \$17,299 ⁹⁹
10	27'	144	✓	✓	1135282 \$16,399 ⁹⁹	1196641 \$18,499 ⁹⁹



ADA STADIUM SEATING

- The chart below gives specifications for some popular designs.
- Bleachers have galvanized steel frames and meet I.B.C. 2000 Building Code Requirements
- Elevated bleachers include 63" wide front walkway and 36" high elevation
- Actual shipping charges apply
- Please call for pricing and further details

CALL FOR PRICING!

ROWS	SEATS	LENGTH	DEPTH	HEIGHT	CODE	DELIVERY
10	284 + 5 Handicap	55' - 6"	25' - 6"	14' - 3"	1383877	
10	497 + 6 Handicap	91' - 6"	25' - 6"	14' - 3"	1383878	
10	740 + 8 Handicap	133' - 6"	25' - 6"	14' - 3"	1383879	
10	983 + 10 Handicap	175' - 6"	25' - 6"	14' - 3"	1383880	
15	495 + 6 Handicap	61' - 6"	17' - 7"	17' - 7"	1383881	
15	749 + 7 Handicap	91' - 6"	17' - 7"	17' - 7"	1383882	
15	1,003 + 8 Handicap	121' - 6"	17' - 7"	17' - 7"	1383883	
15	1,493 + 10 Handicap	175' - 6"	17' - 7"	17' - 7"	1383884	

NJ State Approved Co-op #65MCESCPS - Metuchen/Garden State AppareBid Term: 5/9/18 - 5/8/20: Extended to 5/8/21

CUSTOM SPECTATOR SEATING

BLEACHERS



PERMANENT GRANDSTANDS



A PLAYCORE Company

Custom Grandstands and bleachers built to meet your needs.

- Permanent Grandstands
- Existing Structure Renovations
- Portable Angle Frame Bleachers

PORTABLE ANGLE BLEACHERS



NJ State Approved Co-op #65MCECCPS

EXISTING STRUCTURE RENOVATIONS

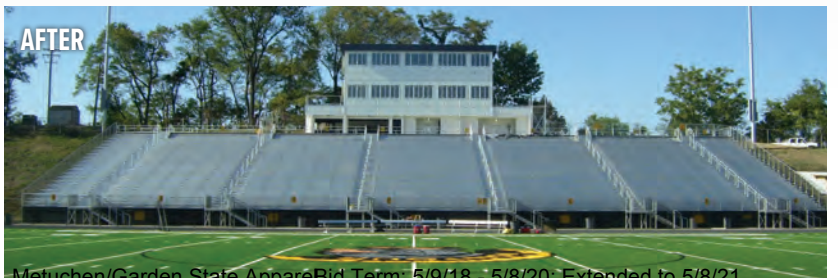

Metuchen/Garden State AppareBid Term: 5/9/18 - 5/8/20; Extended to 5/8/21



5 ROW SUPREME BLEACHERS INCLUDE VERTICAL PICKET GUARDRAILS



30" Spacing
(Typical Bleacher is 24" Spacing)

INCLUDES 12" WIDE SEAT PLANK VS. 10"

SUPREME BLEACHERS

- 20% More Leg Room (30" row spacing instead of standard 24")
 - Wider Seat Planks for Added Comfort (12" wide instead of 10")
 - Supreme Bleachers feature welded aluminum frames, vertical picket guardrail system & 3 foot planks per row (note: 3 row Supreme bleacher does not have a guardrail system)
 - Comes with or without vertical aisle and handrail
 - 3 row bleachers are 70" deep
 - 5 row bleachers are 130" deep
- 3 Year Limited Warranty**

WITHOUT VERTICAL AISLES					
ROWS	LENGTH	SEATS	WEIGHT	CODE	PRICE
3	15'	30	500 lbs	1274851	\$2,999 ⁹⁹
3	21'	42	553 lbs	1274868	\$3,799 ⁹⁹
3	27'	54	750 lbs	1274875	\$4,399 ⁹⁹
5	15'	50	1300 lbs	1274912	\$8,499 ⁹⁹
5	21'	70	1521 lbs	1274882	\$7,499 ⁹⁹
5	27'	90	2055 lbs	1274929	\$9,399 ⁹⁹
WITH VERTICAL AISLES					
ROWS	LENGTH	SEATS	STANDARD	STANDARD	PRICE
5	15'	42	2490 lbs	1274899	\$8,699 ⁹⁹
5	21'	58	2990 lbs	1274936	\$11,999 ⁹⁹
5	27'	74	3940 lbs	1274905	\$10,999 ⁹⁹

NOTE: Bleachers are shipped knocked down.



FIRST CLASS BLEACHERS

- First Class Bleachers feature welded aluminum angle frames, vertical aisle with handrail, vertical picket guardrail system.
 - 4 row bleachers are 130" deep
 - 8 row bleachers are 276" deep
 - 50% More Leg Room (36" row spacing instead of 24")
 - Superior Sight Lines (14" rise instead of standard 8")
 - Backrests on Every Row (for maximum comfort)
 - Wider Seat Planks for Added Comfort (12" wide seat planks instead of 10")
 - Actual shipping charges apply
- 3 Year Limited Warranty**

First Class Bleachers feature welded aluminum angle frames, vertical aisle with handrail, vertical picket guardrail system. 4 row bleachers are 132" deep. 8 row bleachers are 276" deep. **Actual shipping charges apply.**

FIRST CLASS BLEACHERS					
ROWS	LENGTH	SEATS	WEIGHT	CODE	PRICE
4	19'6"	43	1550 lbs	K72481	\$10,999 ⁹⁹
4	25'6"	59	2050 lbs	1274950	\$12,399 ⁹⁹
4	31'6"	75	2400 lbs	1275100	\$13,699 ⁹⁹
8	19'6"	83	3220 lbs	1275117	\$18,799 ⁹⁹
8	25'6"	115	4200 lbs	1275124	\$23,899 ⁹⁹
8	31'6"	147	4900 lbs	1275131	\$26,899 ⁹⁹

NOTE: Bleachers are shipped knocked down.



LEG ROOM STANDARD BLEACHER vs LEG ROOM FIRST CLASS BLEACHER

Bid #ESCNJ 17/18-31

Educational Services Commission of New Jersey

Athletic Equipment & Supplies

TRANSPORTABLE PREFERRED BLEACHERS

- Designed to be moved around your grounds (5 mph max)
- Each transportable bleacher is fitted with a galvanized steel horizontal lifting brace, and has extra bracing to stabilize the bleacher during transport.
- Transportable bleachers come with ground sills and require the purchase of one transport kit which can move several bleachers, one at a time
- Both Preferred and Deluxe Bleachers feature double foot planks on all rows w/single seat planks, riser closure on rows 4 and up with chain-link guardrail starting at row 3.
- Deluxe Bleachers also include the added benefit of a handrail

5 Year Limited Warranty

PREFERRED DESIGN BLEACHERS 					
ROWS	LENGTH	SEATS	WEIGHT	CODE	PRICE
5	15'	50	1028 lbs	NBT0515P	\$5,099 ⁹⁹
5	21'	70	1446 lbs	NBT0521P	\$6,749 ⁹⁹
5	24'	80	1559 lbs	NBT0524P	\$7,199 ⁹⁹
10	15'	100	2161 lbs	NBT1015P	\$9,949 ⁹⁹
10	21'	140	3068 lbs	NBT1021P	\$13,149 ⁹⁹
10	24'	160	3285 lbs	NBT1024P	\$13,949 ⁹⁹



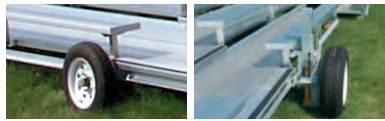

TRANSPORT KIT (REQUIRED)

5 Year Limited Warranty



NBTK5
NBTK10

5 Row Transport Kit - Required with 5 row Transportable Bleachers
10 Row Transport Kit - Required with 10 Row Transportable Bleachers

\$1,499⁹⁹ EA 
\$4,399⁹⁹ EA 

DELUXE DESIGN BLEACHERS

ROWS	LENGTH	SEATS	WEIGHT	CODE	PRICE
5	21'	58	1519 lbs	NBT0521D	\$7,349 ⁹⁹
5	24'	68	1641 lbs	NBT0524D	\$7,799 ⁹⁹
10	21'	113	3193 lbs	NBT1021D	\$14,249 ⁹⁹
10	24'	133	3422 lbs	NBT1024D	\$15,099 ⁹⁹



BLEACHER COVERS

- Perfect for providing safety and comfort by protecting spectators from foul balls and excessive sunlight.
- All units feature durable black powder-coated steel posts designed for permanent installation
- Exclusive Shadsure® cloth covering to block over 90% of harmful UV rays
- Professional installation recommended
- All structures have a 90 MPH windload rating and 5 lb. snowload rating (call for details on higher ratings)
- California public schools must call for DSA information.
- Please allow 6 to 8 weeks for delivery
- All covers carry a 10 year limited warranty with the exception of Red cover which carries a 3 year limited warranty.

STEEL

COLOR OPTIONS

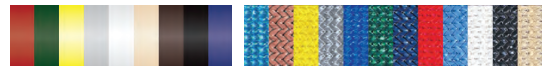

FABRIC



1) Slanted Bleacher Covers Front is 10'H and Rear is 13'H

1100662	18' x 26'	\$6,599 ⁹⁹ EA	
1100716	20' x 26'	\$7,099 ⁹⁹ EA	

2) Standard Bleacher Covers

1100617	10'H x 15' x 15'	\$4,299 ⁹⁹ EA	
1100518	10'H x 18' x 27'	\$4,799 ⁹⁹ EA	
1100563	12'H x 18' x 36'	\$9,599 ⁹⁹ EA	

3) Single Post Pyramid

1100860	10' x 10'	\$2,899 ⁹⁹ EA	
1100914	12' x 12'	\$3,099 ⁹⁹ EA	
1100969	14' x 14'	\$3,499 ⁹⁹ EA	



CANOPY WALL PANEL KIT

- Includes 3 solid walls and 1 zippered entrance wall - all white

1248289 \$199⁹⁹ SET



WEIGHT PLATES FOR QUIK® SHADE

- Secure your canopy against light winds with these 5 lb. weight plates

2001822 \$99⁹⁹ SET OF 4



QUIK® SHADE CANOPY

- One-piece, fully assembled, commercial grade, powder coated frame
- 100% UV protection 300 denier polyester top
- Multiple height adjustments
- Comfortably shades 8-10 people
- Wheeled carry bag included
- Weighs only 50 lbs.

1334586 10' x 10' - White \$299⁹⁹ EA





CUSTOMIZE YOUR CAGE

ADD YOUR SCHOOL NAME, MASCOT OR LOGO

CHOOSE FROM 20 SUPREME SKIRT COLOR OPTIONS!



SUPREME SKIRT

- Made with exclusive Vipol® Matrix Material, a super-durable mesh fabric of tightly woven micro-fibers.
- Virtually tear-proof with 22% wind pass through.
- Fully sun-UV and mildew inhibitor protected.

1300574	Supreme Skirt - Blank - Specify color	\$419 ⁹⁹ EA
1298154	Supreme Skirt Letters - Up to 24" Tall	\$57 ⁹⁹ EA



BUBBA ELITE BATTING CAGE

BASEBALL/SOFTBALL



BUBBA ELITE BATTING CAGE

- Dual coaches observation platforms, 8.5" W x 18" H pneumatic tires, premium ricochet padding most frame work, 3.5mm weather-treated EHT net w/extra 10' x 10' baffle net, nylon reinforced 18oz. vinyl skirt, black thud pad w/grommets, and lockable dolly lift system portability
- Constructed of 2" heavy-wall aluminum tubing
- Collapses to only 5' high to limit storage
- Interior Dimensions: 18' W x 22' D x 12' H
- Exterior Width: 20' W
- Thud pad: 68" W x 52" H x 4" D
- Shipping Wt 625 lbs.

STOCK SKIRT COLORS



\$4,999⁹⁹

BSELITE ★ Complete Unit

\$579⁹⁹

1316681 ★ Replacement Dolly

\$869⁹⁹

BSBNT ★ Replacement Net

\$399⁹⁹

BSBSK ★ Replacement Skirt

\$32⁹⁹

\$329⁹⁹

COLLAPSIBLE & PORTABLE



FOLDABLE, PORTABLE BATTING CAGE

- Constructed of 2" O.D. 14 gauge flo-coated galvanized steel
- Features a lockable dolley lift system, three 16"D x 4"W pneumatic tires for easy mobility, 3.5 mm weather-treated EHT net with extra baffle net, 18' of ricochet cushion
- Optional 18 oz. vinyl skirt available for those who want a solid lower backdrop
- Interior dimensions: 16.5'W x 16.5'D x 11'H
- Weight: 650 lbs.

BS4000F	Complete unit	\$3,549 ⁹⁹ EA ★
1273830	Ricochet Cushion - sold in 6' lengths	\$32 ⁹⁹ EA ★
1274059	Replacement Skirt - Black Only	\$299 ⁹⁹ EA
1274042	Replacement Dolley	\$599 ⁹⁹ EA ★
BS4FNET	Replacement Net only	\$899 ⁹⁹ EA ★



PORTABLE BATTING CAGE

- Constructed of 2" O.D. 14 gauge flo-coated galvanized steel.
- Cage features include: lockable dolley lift system, three 16"D x 4"W pneumatic tires for easy mobility, heavy-duty 3.5 mm weather-treated EHT netting with extra baffle net behind batter.
- Extra width to accommodate left or right hand hitters without shifting the cage.
- Dims: 18'W x 12'D x 12.5'H
- Wt 500 lbs.

BS4000	Complete unit	\$2,949 ⁹⁹ EA ★
1273830	Ricochet Cushion - sold in 6' lengths	\$32 ⁹⁹ EA ★
1274042	Replacement Dolley	\$599 ⁹⁹ EA ★
BS4NET	Replacement Net only	\$899 ⁹⁹ EA ★



SAFEFOAM PADDING

- Premium grade padding for fence tops, pipes, rails, around dugouts, etc.
- Pre-slit for easy installation
- Fits completely over any round pipe that is 2-1/8" in diameter
- Secure with 19" tie wraps (sold separately)
- Minimum order of 6 pieces

5 Year Limited Warranty

Color Options: **Black, Blue, Grey, Green, Purple, Red, Yellow.**

1158847	Padding (8' piece)	\$59 ⁹⁹ EA
1274035	Tie wraps (Black,Blue,Green,Red,Yellow)	\$59 ⁹⁹ 100/SET



COACH'S VIEWING PLATFORM

- Coaches can now view batting practice from this portable, adjustable stand.
- Constructed of 1 1/2" round aluminum tubing.
- Each stand is 20" wide and 10.5" from the ground.
- The stand will fold for safety and convenient storage.

5 Year Limited Warranty

BSBCPLT		\$329 ⁹⁹ EA ★
----------------	--	--------------------------

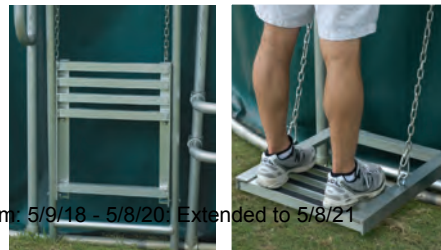

**BIG BUBBA
PRO BATTING CAGE**



BASEBALL/SOFTBALL

BIG BUBBA PRO BATTING CAGE

- Constructed of 2" heavy-wall aluminum tubing, pneumatic tires, 42' of ricochet cushion, 3.5mm weather treated EHT net w/ extra 10'x10' baffle net, 18oz. vinyl skirt and lockable dolly lift system for easy portability.
 - Optional thud pad features 18oz. vinyl cover.
 - Interior Dims: 18'W x 22'D x 12'H
 - Collapses to 19' W X 13.5' D X 5.5' H
 - Exterior width: 19'W
 - Shipping weight 408 lbs.
- 5 Year Limited Warranty**



\$4,499⁹⁹

BSBUBBA ★ Complete Unit

QUICKLY COLLAPSES FOR PORTABILITY & STORAGE

ADDITIONAL OPTIONS

1273830	Ricochet Cushion - sold in 6' lengths	\$32 ⁹⁹ EA ★
1150988	4' H x 6' L Thud Pad (specify color)	\$364 ⁹⁹ EA
BSBSK	Repl. vinyl skirt (specify color)	\$399 ⁹⁹ EA
1274042	Replacement Dolly	\$599 ⁹⁹ EA ★
BSBNT	Replacement Net with Baffle	\$869 ⁹⁹ EA

STOCK SKIRT COLORS



VARSITY TUNNEL FRAMES

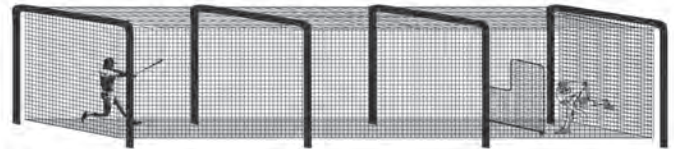

VARSITY TUNNEL FRAMES

- Constructed of 2" round, 13 gauge galvanized steel powder coated black tubing
- System includes upright poles, cross member, ground sleeves, cable, clamps, eyebolts, turnbuckle and snap rings
- Fits all cages up to 14' W and 12' H
- Frame size after installation is 16' W x 12' H
- Net will hang at 11' - allowing 1' on the ground to contain balls
- Recommend: Collegiate Series Tunnel Nets - sold separately
- 3 Section frame for nets 55' and shorter
- 4 Section frame for nets 70' and longer

BS10000	3 Section Frame	\$1,549 ⁹⁹ EA ★	
BS10004	4 Section Frame	\$1,849 ⁹⁹ EA ★	
1235807	Replacement Hardware Only	\$299 ⁹⁹ EA ★	

PRO TUNNEL FRAMES



Shown with Turf Roll (sold separately)

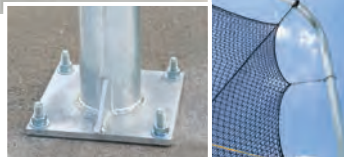

PRO TUNNEL FRAME

- Super-Duty 3.5" OD 13-gauge galvanized steel pipe
- Available in surface mount, in ground and semi-permanent (with use of optional ground sleeves)
- Includes steel cable, clamp, turn buckles and quick links
- Complete installation instructions and hardware included
- 16' W x 11.5' H

5 Year Limited Warranty

1253634	3 Section Frame - Surface Mount	\$2,399 ⁹⁹ EA ★	
1274639	4 Section Frame - Surface Mount	\$2,899 ⁹⁹ EA ★	
1375091	3 Section Frame - In Ground	\$2,099 ⁹⁹ EA ★	
1375092	4 Section Frame - In Ground	\$2,599 ⁹⁹ EA ★	
1375093	Ground sleeves (optional)		

NJ State Approved Co-op #65MCECCPS, Metuchen/Garden State Apparel Bid Term: 5/9/18 - 5/8/20: Extended to 5/8/21



BATTING CAGE DOOR

- All steel frame - easy to assemble
- Free standing door
- Lacing rope included
- Door size: 30 1/2"W x 72 1/2"H
- Door frame: 33 3/4"W x 76 1/2"H
- Weight 35 lbs.

1362312

\$269⁹⁹ EA



SUSPENSION KITS

INDOOR WALL TO WALL SUSPENSION KIT

- Includes everything you need to suspend a batting cage tunnel between two walls inside a gym or training facility (net not included)

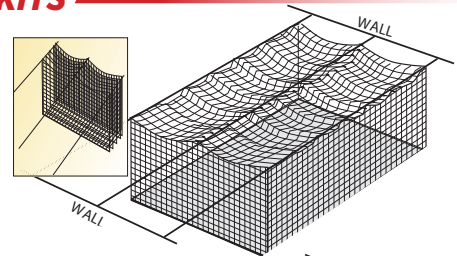

1236637

\$399⁹⁹ EA

CEILING NET SUSPENSION KIT

- Includes everything you need to suspend a batting cage tunnel from the ceiling inside a gym or training facility (net not included)

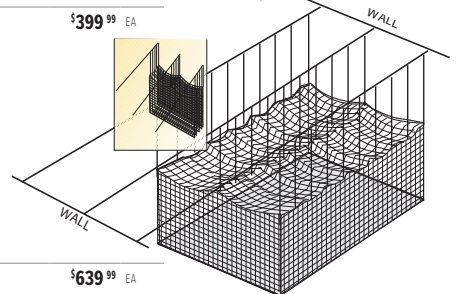

1236644

\$639⁹⁹ EA

COLLAPSIBLE TUNNEL



COLLAPSIBLE BATTING TUNNEL

- Perfect for those that want a standard sized tunnel with limited space
- Choose indoor or outdoor model in 54' or 72' length
- Collapses to 2' for easy storage in less than two minutes
- Net features black 42 thread knotless nylon construction
- Cage arches are galvanized steel
- Cage comes with an instructional video



COLLAPSED

BATCO CAGES ARE VERY LARGE - BE SURE YOU HAVE ENOUGH ROOM IN YOUR GYM. NO RETURNS ALLOWED.

1236644

Baseball Size - 72' L x 18' W x 12' H

\$6,379⁹⁹ EA

\$7,099⁹⁹ EA



TUNNEL NETS



QUALITY. DURABILITY. CRAFTSMANSHIP.

OVER 125 YEARS



BASEBALL/SOFTBALL



ALL-STAR NYLON TWISTED/KNOTTED BATTING TUNNEL NETS

- 3.5mm, 1-3/4" black nylon netting
- 36 thread twisted knotted
- 380 lb. breaking test
- Nyothene weather treatment for outdoor use
- Durable vinyl border to prevent fraying
- Includes 14' x 12' backing to resist net wear behind batter
- Includes three full-length ropes to prevent sagging

1245059	55'L x 14'W x 12'H	\$1,749 ⁹⁹	EA ★	
1245042	70'L x 12'W x 12'H	\$1,849 ⁹⁹	EA ★	
1245035	70'L x 14'W x 12'H	\$1,929 ⁹⁹	EA ★	

PRO SERIES TUNNELS

- 2.5mm #42 twisted knotted polyethylene
- 225 lb. breaking strength
- 100% water proof and UV treated
- Extruded permanent black color
- 1 3/4" square mesh
- Three ropes running lengthwise on top and all 4 corners for "no sag" net system

BS37014	70'L x 14'W x 12'H	\$1,269 ⁹⁹	EA ★	
BS37012	70'L x 12'W x 12'H	\$1,179 ⁹⁹	EA ★	
BS35544	55'L x 14'W x 14'H	\$979 ⁹⁹	EA ★	
BS35514	55'L x 14'W x 12'H	\$989 ⁹⁹	EA ★	
BS35512	55'L x 12'W x 12'H	\$914 ⁹⁹	EA ★	

COLLEGIATE SERIES TUNNELS

- 2.0mm #24 twisted knotted polyethylene
- 185 lb. breaking strength
- UV treated - 100% waterproof
- 2mm size 1 3/4 square mesh
- For indoor or outdoor use
- Same great features as Pro Series tunnels, but for those on a tighter budget

BS27014	70'L x 14'W x 12'H	\$949 ⁹⁹	EA ★	
BS27012	70'L x 12'W x 12'H	\$859 ⁹⁹	EA H	
BS25544	55'L x 14'W x 14'H	\$879 ⁹⁹	EA ★	
BS25514	55'L x 14'W x 12'H	\$839 ⁹⁹	EA ★	
BS23514	35'L x 14'W x 12'H	\$599 ⁹⁹	EA H	

NET SAVERS



TUNNEL/CAGE SAVERS

- Heavy duty reinforced vinyl tarp to protect the netting in your batting cage
 - Includes grommets and corner ropes
 - Size - 5'W x 7'H
- Color Options: **Dark Green, Royal, Red.**

1236651	22 oz. vinyl w/ White Target	\$219 ⁹⁹	EA
1269918	30 oz. black w/ Orange Target	\$219 ⁹⁹	EA
1269925	30 oz. Navy w/ Yellow Target	\$219 ⁹⁹	EA



BATTING TUNNEL NET PROTECTOR PAD

- Protect your tunnel with this vinyl covered backstop pad
- Perfect for any indoor or outdoor batting cage
- Size - 3'W x 4'H x 1-1/2" thick

200180453	\$169 ⁹⁹	EA
-----------	---------------------	----



VINYL BACKDROP WITH TARGET

- Constructed of heavy duty 40oz. vinyl with white strike zone.
- Strike zone is 18"W x 30"H

579767	\$169 ⁹⁹	EA
--------	---------------------	----

NJ State Approved Co-op #65MCESCCPS - Metuchen/Garden State Apparel Bid Term: 5/9/18 - 5/8/20. Extended to 5/8/21

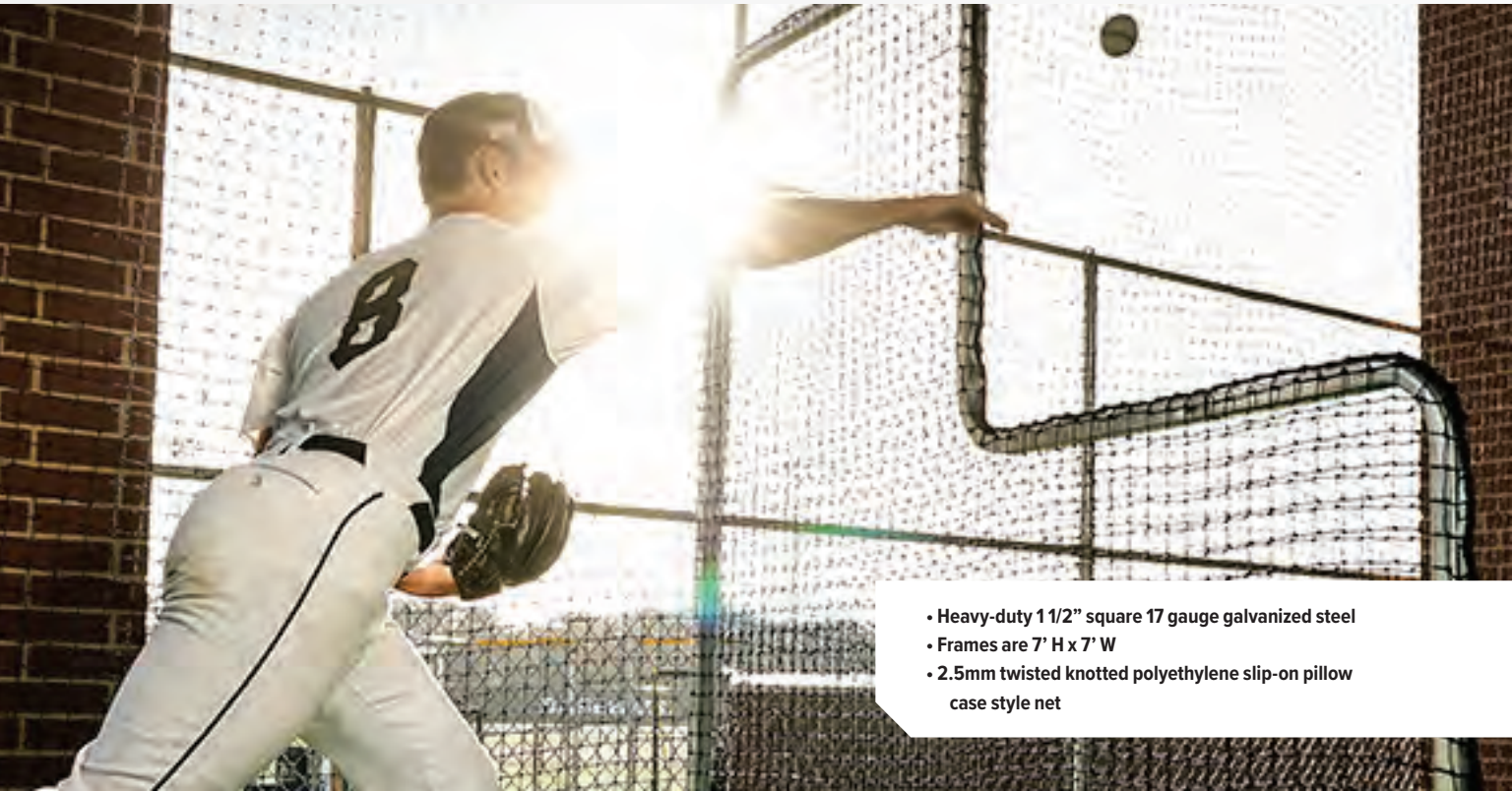

- Heavy-duty 1 1/2" square 17 gauge galvanized steel
- Frames are 7' H x 7' W
- 2.5mm twisted knotted polyethylene slip-on pillow case style net



PITCHERS PROTECTOR

BS47743 Complete Unit \$297.99 EA ★ **S&H**
BS47743NET Replacement Net \$134.99 EA ★

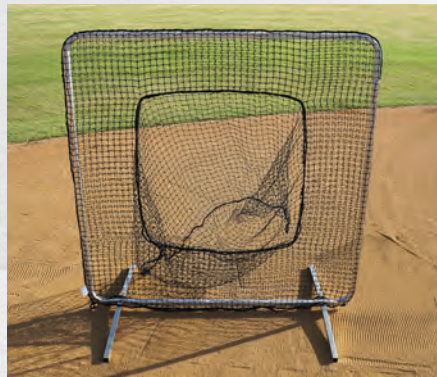

SOCK NET AND FRAME

BS47700 Complete Unit \$364.99 EA ★ **S&H**
BS47700NET Replacement Net \$164.99 EA ★



C-SHAPED SOFTBALL PITCHERS PROTECTOR

1366836 Complete Unit \$294.99 EA ★ **S&H**
1366836N Replacement Net \$137.99 EA ★



SOFTBALL PITCHER PROTECTOR

BS47750 Complete Unit \$294.99 EA ★ **S&H**
BS47750NET Replacement Net \$134.99 EA ★



FIRST BASE / FUNGO PROTECTOR

BS47710 Complete Unit \$117.99 EA ★ **S&H**
BS47710NET Replacement Net \$117.99 EA ★



L-SCREEN W/ HOOD

1378703 Complete Unit \$144.99 EA ★ **S&H**
1378703 Replacement Net \$144.99 EA ★

NJ State Approved Co-op for ESCNJ Bid Terms 5/18 - 5/8/20; Extended to 5/8/21

PROFESSIONAL

- Oversized for maximum protection
- Heavy wall construction
- Slip-over pillow case (3.0 mm) NYLON NET INCLUDED
- 10" NO flat tires for easy transporting



BASEBALL/SOFTBALL



PRO L-SCREEN

BSPROL	Complete Unit - 8' x 8' - Aluminum (on field)	\$789 ⁹⁹ EA ★ S&H
BSPROLS	Complete Unit - 8' x 8' - Steel (on field or in tunnel)	\$789 ⁹⁹ EA ★ S&H
BSLPRON	Replacement Net - 8' x 8'	\$249 ⁹⁹ EA ★
1378694	Complete padding option for L-Screen	\$99 ⁹⁹ EA ★



MINI PRO L-SCREEN

BSFPRO5	Complete Unit (5' x 7' - on field)	\$589 ⁹⁹ EA ★ S&H
1296464	Replacement Net	\$169 ⁹⁹ EA ★
1378702	Complete padding option for Mini L-Screen	\$99 ⁹⁹ EA ★



TRI-FOLD FUNGO SCREEN

BSFPRO16	Complete Unit - 8' H x 16' W	\$1,099 ⁹⁹ EA ★ S&H
BSFPRO8M	Replacement Net - Middle Section	\$229 ⁹⁹ EA ★
1265279	Replacement Net - Side Wings (pair)	\$249 ⁹⁹ EA ★



BASE/FUNGO SCREENS

BSFPRO10	Complete Unit - 10' x 10'	\$889 ⁹⁹ EA ★ S&H
BSFPRO10N	Replacement Net - 10'H x 10' W	\$249 ⁹⁹ EA ★
BSFPRO8	Complete Unit - 8' x 8'	\$799 ⁹⁹ EA ★ S&H
BSFPRO8N	Replacement Net - 8'H x 8' W	\$229 ⁹⁹ EA ★



10' W/HOOD & WINGS (BSCL10HW)

CHAIN LINK BACKSTOPS

- Permanent backstops are erected by installing supplied 2-3/8" pipe supports approximately every 10' in concrete footings
- Then, simply bolt prefabricated 5' x 10' panels in place to create your finished backstop
- 5' x 10' panels are composed of 1-5/16" OD galvanized tubing with center reinforcing brace and 9 gauge galvanized woven wire
- Backstops are extremely durable and allow individual panels to be removed or replacement as needed

5 Year Limited Warranty

BSCL10	10' - No Hood or Wings	\$2,129 ⁹⁹ SET ★	SeH
BSCL10H	10' w/Hood-No Wings	\$2,599 ⁹⁹ SET ★	SeH
BSCL10HW	10' w/Hood & Wings	\$2,999 ⁹⁹ SET ★	SeH
BSCL20	20' - No Hood or Wings	\$2,799 ⁹⁹ SET ★	SeH
BSCL20H	20' w/Hood-No Wings	\$3,479 ⁹⁹ SET ★	SeH
BSCL20HW	20' w/Hood & Wings	\$4,229 ⁹⁹ SET ★	SeH

AVAILABLE STYLES

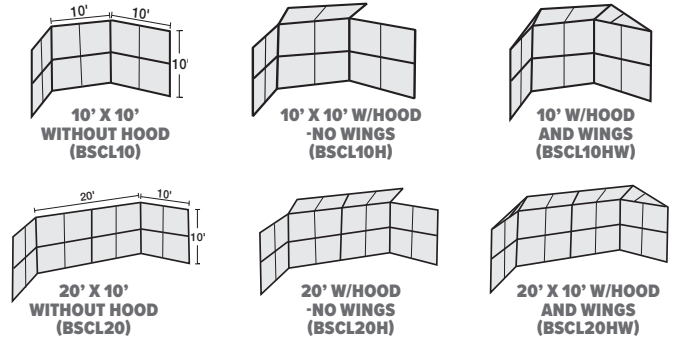

SANDLOT PORTABLE BACKSTOP

- Constructed of heavy duty 2" OD 14 gauge flo-coated galvanized steel
- 9'H x 6'W sidewings and extend to provide up to 28' of backstop
- Semi-pneumatic tires and ground stakes for anchoring
- Heavy duty weather treated nets included
- Weight: 400 lbs.

BBSWING	Complete Unit	\$2,379 ⁹⁹ EA ★	SeH
SNWINGSB	Replacement Net for Wings (Requires 2)	\$199 ⁹⁹ EA ★	
SNWINGCTDS	Replacement Net for Back and Top	\$279 ⁹⁹ EA ★	



BASEBALL HITTING STATION

- 2 3/8" diameter galvanized steel construction
- Installed dimensions - 10'H x 11'W x 1'D
- Can be installed permanently or semi permanent with included ground sleeves
- Turf mat not included - see page 37

3 Year Limited Warranty

BBHITSTA	Complete Unit	\$699 ⁹⁹ EA ★	SeH
-----------------	---------------	--------------------------	------------

Bid #ESCNJ 17/18-31

Educational Services Commission of New Jersey

Athletic Equipment & Supplies

CALL FOR FREIGHT QUOTE

FENCE GAURDS

POLY-CAP FENCE GUARD

- Installed over your chain link fence adds safety and reduces player injuries
- Increases visibility
- Beautifies any field
- Weather treated and UV protected
- 4-1/2" in diameter
- **Actual freight charges apply**

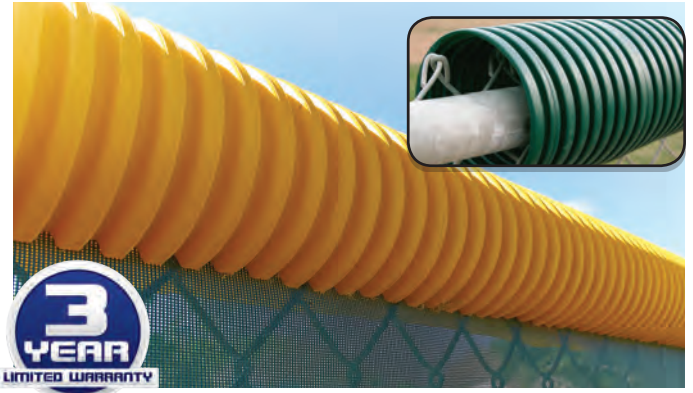

BBPC100X	Yellow 100'	\$179 ⁹⁹ ROLL	
BBPC250X	Yellow 250'	\$239 ⁹⁹ ROLL	
1024005	Green 100'	\$179 ⁹⁹ EA	
1024012	Green 250'	\$239 ⁹⁹ EA	
BBPCTIES	Yellow 18" tie wraps	\$57 ⁹⁹ PACK OF 100	
1048988	Green 18" tie wraps	\$58 ⁹⁹ PACK OF 100	
5POLYINST	Poly Cap Installation Tool	\$77 ⁹⁹ EA	

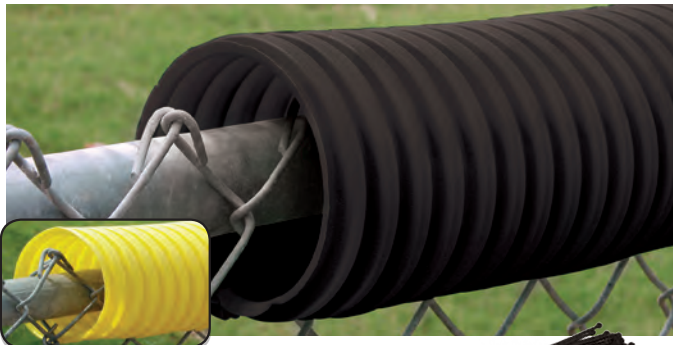

FENCE CROWN PROTECTIVE FENCE GUARD

- An economical way to increase safety
- Reduce player injuries and increasing visibility
- Weather treated and UV protected
- Slit and ready for easy installation with matching tie wraps every 3'
- Tie wraps NOT included
- **Actual freight charges apply**



BLACK & YELLOW TIE WRAPS
SOLD SEPARATELY

1196726	Bright Yellow - 100'	\$179 ⁹⁹ ROLL	
1196733	Bright Yellow - 250'	\$239 ⁹⁹ ROLL	
1269949	Black - 100'	\$179 ⁹⁹ ROLL	
1269932	Black - 250'	\$239 ⁹⁹ ROLL	
1196764	Yellow - 19" tie wraps - 100 per pack	\$57 ⁹⁹ PACK	
1269956	Black - 19" tie wraps 100 per pack	\$57 ⁹⁹ PACK	



DELUX FENCE TOP RAIL PADDING

- Provides superior appearance and protection on the top of chain link and outfield fences.
- 2" thick foam is encased in 18 oz. vinyl w/ grommets for attachment.
- Fits up to 2 1/2" pipe

1273847 6' section \$98⁹⁹ EA



SAFETY TOP CAP

- Resistance to UV and other harmful climate conditions provides continuous use for years and years
- To install, simply snap over the top of the fence and fasten cap with steel hog rings (included) through the pre-drilled holes
- Bag contains five 8' pieces (40' per bag)

1273854 Yellow Only \$79⁹⁹ BAG



SAF-TOP FENCE GUARDS (10-PACK)

- Protect against injuries, increase visibility add beauty to your field
- UV-resistant polyethylene construction is maintenance free
- Sold in boxes of 10 - each 8'L x 3"W x 4"H (80 linear feet per box)
- Pre-drilled and includes ties for quick & easy installation
- 5-year limited warranty

Color Options: **Dark Green, Yellow, Blue, Red.**

1234893 \$192⁹⁹ SET OF 10





TUFFY® WINDSCREEN

- The toughest, highest quality windscreen in the world
- Made with exclusive Vipo!® Matrix 10 oz. material, a super-durable mesh fabric of tightly woven micro fibers
- Offers more sun UV resistance, is virtually tear proof, and has the highest puncture and tear resistance
- Allows 22% wind pass-through - 78% shade factor
- Tuffy is the only windscreen featuring LOCK-STITCH finishing to assure that it's sides and corners do not unravel
- Fully sun UV and mildew inhibitor protected
- Grommets every 12" on all 4 sides
- 9' model complete with half moon vents and a grommet strip line

5 Year Limited Warranty

1323566	up to 5'H	\$0.93	SQ.FT
1285598	6'H	\$0.95	SQ.FT
1285604	9'H	\$0.99	SQ.FT
1298253	Boxed Air Vent	\$9.99	EA



CHROMA-BOND® IMPRINTING

- Double coated multicolor imprinting that does not fade, flake or scuff like other spray on or digital imprinting
- Images are sharp, vivid and outlast any other type of imprinting
- School colors can be matched

2 Color Logo & Lettering on a 3rd Color Background

1297782	Overall Size up to 4'H x 50'L	\$1,899.99	EA
1297799	Overall Size up to 3'H x 30'L	\$1,599.99	EA

1, 2 or 3 Color Print

1380610	1 Color up to 25 sq. ft.	\$599.99	EA
1380611	1 Color 26-50 sq. ft.	\$749.99	EA
1380613	2 Color up to 25 sq. ft.	\$699.99	EA
1380614	2 Color 26-50 sq. ft.	\$849.99	EA
1380616	3 Color up to 25 sq. ft.	\$799.99	EA
1380617	3 Color 26-51 sq. ft.	\$949.99	EA

1 or 2 Color Letters only

1298154	Up to 24" T	\$57.99	EA
1298161	Up to 36" Tall	\$64.99	EA
1298178	Up to 48" Tall	\$79.99	EA
1298185	Up to 60" Tall	\$93.99	EA
1298192	Up to 72" Tall	\$114.99	EA
1298208	Up to 84" Tall	\$124.99	EA

WINDSCREEN ACCESSORIES

1397737	Boxed Vent	\$9.99	EA
1397738	Lacing Lip	\$0.09	EA
MTWRAPS	7" Tie wraps (50 lbs. breaking strength)	\$17.99	PACK
MTSHOOKS			

FONTS AVAILABLE

ALL STAR VARSITY On English

SPECIFY COLORS FOR ALL IMPRINTS. CALL FOR MORE FONT OPTIONS



BASEBALL/SOFTBALL

BSN SPORTS' POLYESTER WINDSCREEN

- 8oz. weight/sq. yard construction, 84% shade factor, maximum UV protection
- Custom cut to any size
- Brass tooth grommets spaced every 18" on all four sides
- IncrediSeal - eliminates all sewing and stitching
- 9' comes standard with lacing lip and half moon vents
- Match school logos exactly-digitally printed directly from your image file
- State of the art digital printing with unlimited color options

Without Printing

1393784	up to 5'H	\$0.77 SQ.FT
1393785	6'H	\$0.78 SQ.FT
1393786	9'H	\$0.80 SQ.FT

With Printing

1398129	up to 5'H	\$5.99 SQ.FT
1398130	6'H	\$5.99 SQ.FT
1398131	9'H	\$5.99 SQ.FT

FOREST GREEN	ROYAL BLUE	BLACK
NAVY	ORANGE	MAROON
RED	CAROLINA BLUE	KELLY GREEN
BROWN	TAN	PURPLE
WHITE	GRAY	YELLOW



ARMORMESH WINDSCREEN

- Features 14 oz. woven, extrusionvinyl-coated polyester
- Excellent tear strength and outstanding abrasion resistance
- Fabricated with IncrediSeal technology
- 75% shade factor
- Lacing lip and half moon vents standard on screens over 6'
- Match school logos exactly-digitally printed directly from your image file
- State of the art digital printing with unlimited color options

Without Printing

1393787	up to 5'H	\$0.85 SQ.FT
1393788	6'H	\$0.86 SQ.FT
1393789	9'H	\$0.88 SQ.FT

With Printing

1398132	up to 5'H	\$6.49 SQ.FT
1398133	6'H	\$6.49 SQ.FT
1398134	9'H	\$6.49 SQ.FT

DARK GREEN	ROYAL BLUE	RED
KELLY GREEN	MAROON	NAVY
BLACK	PURPLE	ORANGE
GRAY	CAROLINA BLUE	YELLOW
WHITE		



PROFESSIONAL FOUL POLES (3 1/2" OD POLES)

- Constructed of 3.5" OD 13 gauge heavy duty steel
- Powder coated optic yellow
- Easy to see day or night
- Professional 18"W expanded metal wing
- Sold in pairs

BSFOUL	20' Above Ground, 12' Wing, Weight: 362 lbs/pr.	\$1,479 ⁹⁹ PR ★	
BSFOUL15	15' Above Ground, 8' Wing, Weight: 272 lbs/pr.	\$1,279 ⁹⁹ PR ★	
BSFOUL12	12' Above Ground, 6' Wing, Weight: 220 lbs/pr.	\$999 ⁹⁹ PR ★	

GROUND SLEEVES FOR 3 1/2" OD FOUL POLES

1255294	48" Ground Sleeves for BSFOUL	\$324 ⁹⁹ PR ★
1255287	36" Ground Sleeves for BSFOUL15 or BSFOUL12	\$299 ⁹⁹ PR ★



STANDARD FOLDING BACKSTOP PADDING

- 2" polyfoam covered by heavy duty 18 oz. vinyl
- Pads are made to fold in 2"W panels for storage and shipping
- Grommets along all 4 sides for easy of anchoring
- Order with digital printing to dress up your facility

WITHOUT PRINTING

1397739	3'H x 6'L - Weights 12 lbs.	\$339 ⁹⁹ EA
1397753	3'H x 8'L - Weights 16 lbs.	\$379 ⁹⁹ EA
1397767	3'H x 10'L - Weights 20 lbs.	\$424 ⁹⁹ EA
1397781	3'H x 12'L - Weights 24 lbs.	\$484 ⁹⁹ EA
1397795	4'H x 6'L - Weights 16 lbs.	\$389 ⁹⁹ EA
1397809	4'H x 8'L - Weights 20 lbs.	\$407 ⁹⁹ EA
1397823	4'H x 10'L - Weights 25 lbs.	\$479 ⁹⁹ EA
1397838	4'H x 12'L - Weights 30 lbs.	\$549 ⁹⁹ EA

WITH PRINTING

1397852	3'H x 6'L - Weights 12 lbs.	\$416 ⁹⁹ EA
1397866	3'H x 8'L - Weights 16 lbs.	\$516 ⁹⁹ EA
1397880	3'H x 10'L - Weights 20 lbs.	\$619 ⁹⁹ EA
1397894	3'H x 12'L - Weights 24 lbs.	\$720 ⁹⁹ EA
1397908	4'H x 6'L - Weights 16 lbs.	\$519 ⁹⁹ EA
1397922	4'H x 8'L - Weights 20 lbs.	\$623 ⁹⁹ EA
1397936	4'H x 10'L - Weights 25 lbs.	\$799 ⁹⁹ EA
1397950	4'H x 12'L - Weights 30 lbs.	\$949 ⁹⁹ EA



BACKSTOP PADDING

- Designed for use on chain-link fencing or cement
 - Features heavy-duty 18 oz. vinyl construction
 - 4" open cell foam padding for true ball rebound
 - Grommets are exposed on all 4 sides for ease of attachment
 - Upgrade to printed padding for that "WOW" factor
- Color Options: **Black, Gray, Kelly, Maple Green, Maroon, Navy, Orange, Purple, Red, Royal, Sky Blue, Tan, White, Yellow.**

1398099	Without Printing	\$19 ⁹⁹ SQ.FT
1398114	With Printing	\$23 ⁹⁹ SQ.FT



CUSTOM NETTING



Rope Border



Vinyl Border w/Grommets

BASEBALL/SOFTBALL

- Available in four grades of size and strength to fit your budget and program needs.
- All netting is 1-3/4" mesh, all-weather treated and bordered for a neat, modular look.
- Available with either a rope border or a vinyl border with grommets. Please specify.

WHICH CUSTOM NET DO YOU NEED?	ALL-STAR	MVP	MAJOR LEAGUE	VARSITY
TWINE SIZE	#36 Nylon Twisted-Knotted	3.5 mm Enduro Hybrid Thread Braided-Knotless	3.0 mm Enduro Hybrid Thread Braided-Knotless	2.4 mm Enduro Hybrid Thread Braided-Knotless
CONSTRUCTION	#36 Nylon Twisted-Knotted	3.5 mm Enduro Hybrid Thread Braided-Knotless	3.0 mm Enduro Hybrid Thread Braided-Knotless	2.4 mm Enduro Hybrid Thread Braided-Knotless
BREAK STRENGTH (approximate)	380 lbs.	320 lbs.	275 lbs.	195 lbs.
TREATMENT	Additional UV treatment and black color	Extruded thread with built in UV treatment, weather protection and Black color. Weather Proof, Mold and Mildew Resistant	Extruded thread with built in UV treatment, weather protection and Black color. Weather Proof, Mold and Mildew Resistant	Extruded thread with built in UV treatment, weather protection and Black color. Weather Proof, Mold and Mildew Resistant
WT / SQ FT	.040	.050	.036	.023
CODE	1238525	1188059	1188042	1188066
PRICE	\$0.99 sq.ft	\$0.89 sq.ft	\$0.79 sq.ft	\$0.76 sq.ft

BOUNDARY NETTING



NET REPAIR/LACING CORDS

- Black poly twine

1236743 NJ State Approved Co-op #65MCE SC CPS Metuchen/Garden State AppareBid Term: 5/9/18 - 5/8/20: Extended to 5/8/21
MTTWINEB 500' Spool - 3 mm \$39.99 SPOOL ★



PRE-CUT BOUNDARY/PROTECTIVE NETTING

- 1-3/4" mesh, weather treated Varsity (#420) EHT black knotless netting
- Netting is UV resistant
- Heavy overlock stitched rope border
- All panels are rectangular in shape

1236576 Net Size 10' x 30' \$184.99 EA ★
1236583 Net Size 12' x 50' \$299.99 EA ★
1236598 Net Size 14' x 90' \$599.99 EA ★
1236606 Net Size 14' x 100' \$799.99 EA ★



BAFFLE/DIVIDER NET WITH ROPE BORDER

- 2.5mm #42 thread twisted knotted polyethelene
- Net can be hung inside your batting cage to divide it or act as a

1236705 Net Size - 12' x 14' \$149.99 EA ★



PORTABLE OUTFIELD FENCING

Durable polyethylene square mesh fencing, ideal for use as a stand alone outfield fence when combined with the Smartpole staking system. Rolls are 48”H x 150’L. Sold as packages that include fence rolls, poles and socket.

Specify fence color: **Blue, Dark Green, Scarlet**

COMPLETE OUTFIELD PACKAGE

Includes:

- 150’ of fencing (specify color)
- 16 - 60” smartpoles (2 anchor poles + 14 flexible poles)
- 16 - 12” ground sockets with caps
- Punch-pilot hole tool
- Socket setter and installation sheet

Color Options: **Blue, Dark Green, Scarlet.**

MKGMFGS Specify Color **\$489⁹⁹** SET

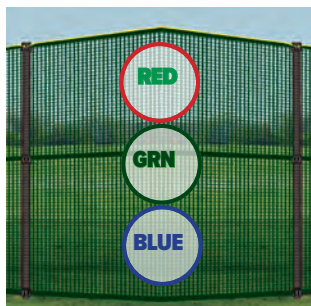

OUTFIELD PACKAGE WITHOUT GROUND SOCKETS

Includes:

- 150’ of Fencing (specify color)
- 16 - 60” SmartPoles (2 anchor poles + 14 flexible poles)
- Punch-pilot hole tool
- Socket setter and installation sheet

Color Options: **Blue, Dark Green, Scarlet.**

MKGMFSS **\$399⁹⁹** SET



SMART POLES WITH GROUND SOCKET KIT

- 16 - 60” SmartPoles (14 flex + 2 anchor)
- 16 - 12” ground sockets
- Punch pilot hole tool
- Socket setter
- 160’ yellow poly rope
- 50 tie wraps for added stability

MK16SP60 **\$339⁹⁹** SET

SMART POLE ONLY KIT

- 16 - 60” SmartPoles (14 flex + 2 anchor)
- Pilot hole
- 160’ yellow poly rope
- 50 tie wraps for added stability

MK16SSCP **\$279⁹⁹** SET

SMARTPOLE FLEXIBLE POLE

- Replacement flexible SmartPole

MKFSG0 Black **\$19⁹⁹** EA

SMARTPOLE REINFORCED ANCHOR POLE

- Replacement anchor pole

MKRS60 White **\$19⁹⁹** EA



16 SMARTPOLE GROUND SOCKETS

Optional set of 32 ground sleeves and caps for 200’ homerun Enduro fence system.

MK16GS12CP 16 Optional Ground Sockets with Caps **\$109⁹⁹** SET

GROUND SOCKET WITH CAP

- Permanently install ground sockets for quick and easy fence installation and tear down

MKGS12 **\$9⁹⁹** EA

FENCING ONLY

- 48”H x 150’L fence only
- Color Options: **Blue, Dark Green, Scarlet.**

1196788 specify color **\$199⁹⁹** ROLL ★



HOW MUCH OUTFIELD FENCE DO YOU NEED?

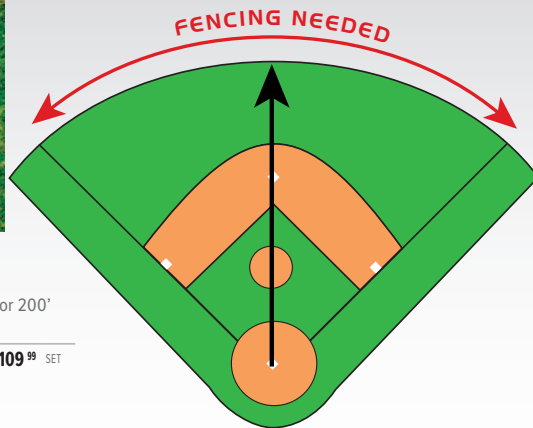

HOME PLATE TO CENTER FIELD

FENCING NEEDED

180'	282.6'
200'	314'
225'	353.25'
250'	392.5'
275'	431.75'
300'	471'
325'	510.25'
350'	549.5'
400'	628'

ENDURO FENCING WITH YELLOW TOP TAPE

Sets a new standard for Simplicity, Durability and Appearance.

Simply slide the poles through the permanent vinyl pockets in the mesh fencing and drive the pole into the turf with a rubber mallet. No ropes, ties, clips, hooks, etc. The vinyl pockets, spaced every 10', create an attachment to the pole that is uniform top to bottom. Steel pilot hole tool is included for hard ground. Optional ground sockets available.

Color Options: **Dark Green, Red, Royal.**

ENDURO FENCING OUTFIELD PACKAGES

Packages include:

- Enduro fence w/pole pockets
- Two (2) white Enduro anchor poles (MKREP1)
- Heavy-duty Enduro flex poles (MKWEP1)
- Steel pilot hole tool

Color Options: **Blue, Dark Green, Red.**

BSF50	50'L Fence with 6 Poles	\$299⁹⁹ SET
BSF150	150'L Fence with 16 Poles	\$659⁹⁹ SET

200' HOMERUN FENCE PACKAGE

Package includes:

- 314' of Enduro fence
- 32 Enduro poles
- Pilot-hole tool
- Measuring tape
- Optional ground sockets not included (see below)
- Dark Green only

BS3146P	Complete Package	\$1,499⁹⁹ EA
BS13516	32 Optional Ground Sockets and Caps	\$199⁹⁹ PACK ★

300' HOMERUN FENCE PACKAGE

Package includes:

- 471' of Enduro fence
- 48 Enduro poles
- Pilot-hole tool
- Measuring tape
- Optional ground sockets not included (see below)
- Dark Green only

BS13515	Complete Package	\$2,099⁹⁹ PACK ★	
BS13518	48 Optional Ground Sockets and Caps	\$299⁹⁷ KIT	

ENDURO FENCE ONLY

- Replacement fence only
- Please specify color

Color Options: **Dark Green, Red, Royal.**

1236897	50' - Roll only	\$199⁹⁹ EA ★
1236927	150' - Roll Only	\$499⁹⁹ EA ★

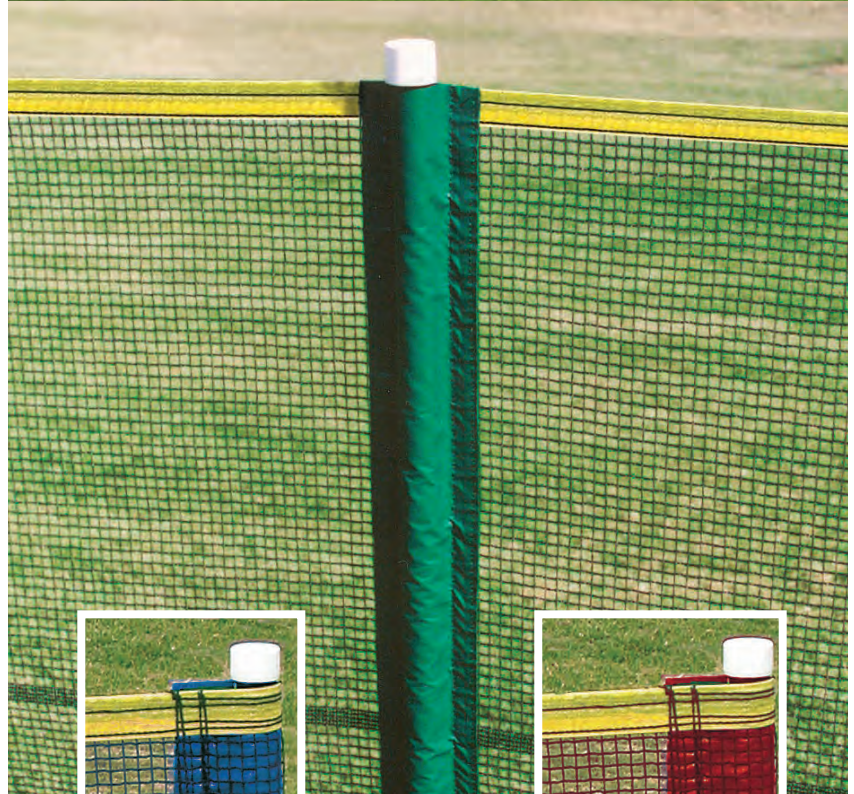
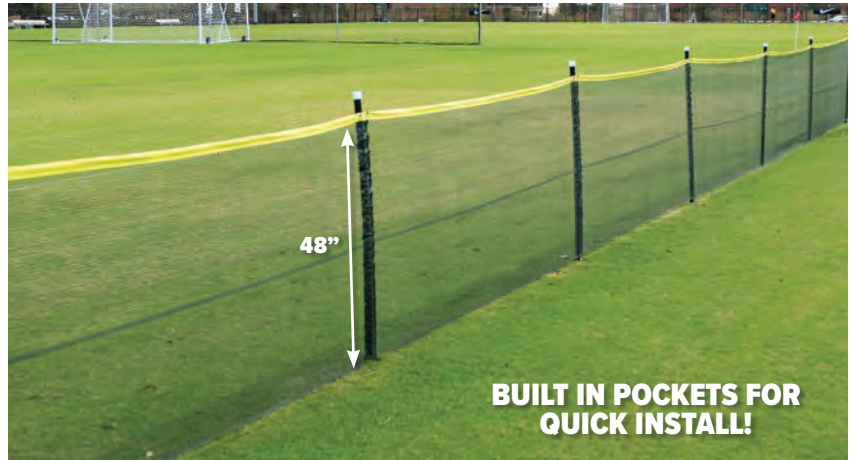

BASEBALL/SOFTBALL

ACCESSORIES

Additional Enduro Poles available for extra stability or replacement.



ENDURO FLEXIBLE POLES

- Replacement flex poles

MKWEP1	Color: Black only	\$19⁹⁹ EA
MKWEP16	Set of 16 (14 Flex + 2 Anchor Poles)	\$259⁹⁹ SET

ENDURO ANCHOR POLE

- Reinforced with metal rod to anchor the Enduro fence system

MKREP1	Color: White only	\$19⁹⁹ EA
---------------	-------------------	-----------------------------

GROUND SOCKET WITH CAP

- Permanently install ground sockets for quick and easy fence installation and tear down

MKCS12		\$9⁹⁹ EA
---------------	--	----------------------------

GROUND SOCKET CAPS

- 12 pack of plugs for MarkSmart ground sockets
 - Use color coded cap for multiple field configurations
- Color Options: **Orange, White, Yellow.**

MKA103Y	Caps Only - Specify Color	\$14⁹⁹ DZN
----------------	---------------------------	------------------------------

GROUND SOCKET SETTERS - ONE PAIR

- Designed to be placed in the ground socket so you can hit these instead of the ground socket directly

MKA106		\$4⁹⁹ PR
---------------	--	----------------------------



SPORTPANEL® FENCING

FEATURES TECHNO-TIP TECHNOLOGY FOR FLEXIBILITY and SAFETY

- Designed for portability, panels are lightweight, durable & weather resistant
- Panels are interchangeable and the system expands to meet nearly any size requirement
- Each panel includes two anchor wickets
- Panels measure 44”H x 10.5’L
- **Actual freight charges apply**

1378436	White Fence Panel	\$199 ⁹⁹ EA	
1273861	White Panel with Yellow Safety Top	\$199 ⁹⁹ EA	
1037098	Black Mesh Fence Panel	\$209 ⁹⁹ EA	
1037128	Foul Poles - 10”H x 15”W	\$217 ⁹⁹ EA	
1037104	Extra Leg Anchoring Wickets	\$49 ⁹⁹ DZN	
1037111	Extra Foam Panel Connectors	\$57 ⁹⁹ DZN	



SPORTS BARRIER FENCING

- Panels are 8’L x 45”H
- Galvanized steel frame for long-lasting, rust free protection
- End interface connections to unify entire installation
- Added lower bars keep ball from rolling away
- Wheels for easy placement and transportability
- **Actual freight charges apply**

1398097

\$299⁹⁹ EA



PORTABLE CHAIN LINK FENCE PANELS

- Heavy duty portable chain link fence panels 4’H x 10’L can be used for home run, sideline, crowd control fencing, etc.
- Constructed of galvanized steel frame with 11 gauge chain link fabric
- Legs pivot for storage
- Supplied with connectors to secure panels together
- Weight: 62 lbs. per panel
- Minimum purchase of 5 panels
- **Actual freight charges apply**

1149432

\$239⁹⁹ EA ★

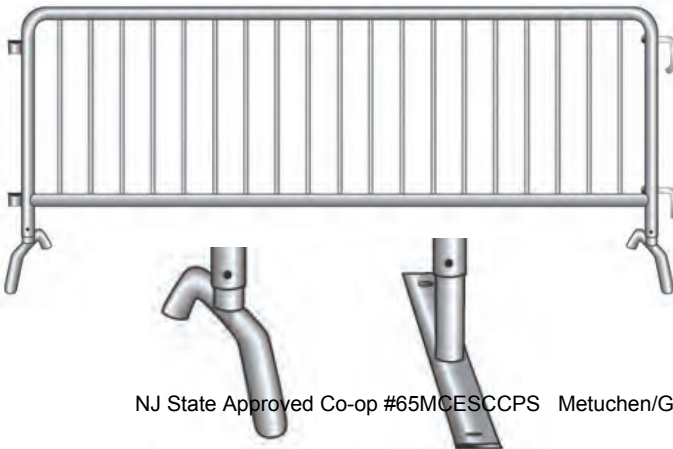

CROWD CONTROL STEEL BARRICADES

- Maintenance free crowd control panels are 43”H x 8’L
- Barricade framework is constructed of 16 gauge hot dip galvanized steel
- Choose bridge foot design for maximum stability or flat foot design when funneling crowds into parallel lines to minimize tripping hazards
- Weight: 54 lbs. per barricade
- **Actual freight charges apply**

1273878
1273885

Bridge Foot Design
Flat Foot Design

\$179⁹⁹ EA
\$179⁹⁹ EA



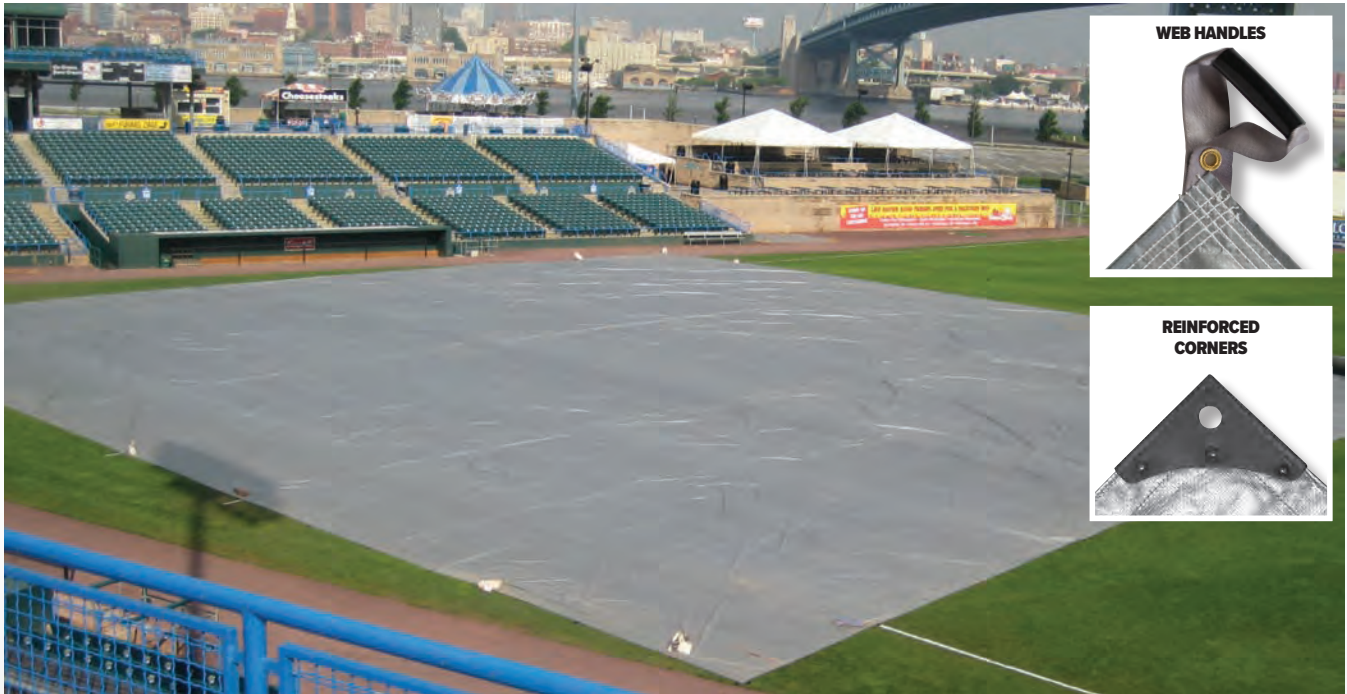

FULL FIELD TARP/COVER

- Constructed of 6 oz woven, 12ml thick polyethylene
- Double-stitched on all four sides with brass grommets placed evenly around the perimeter every 10-12 feet
- Reinforced corners
- Web handles evenly spaced around perimeter every 15' - 20'
- Includes 50 polypro sand bags (sand not included)

3 Year Limited Warranty

1150094	Baseball Cover 170' X 170', Weight: 1200 lbs	\$6,379 ⁹⁹ EA	
1150100	Baseball Cover 160' x 160', Weight: 1090 lbs	\$5,979 ⁹⁹ EA	
1150117	Softball Cover 120' x 120', Weight: 615 lbs	\$3,979 ⁹⁹ EA	
1236774	Youth League Cover 90' x 90', Weight: 400 lbs	\$2,679 ⁹⁹ EA	



FIELD COVER ACCESSORIES

1.	1150148	9" Anchor Stakes	\$39 ⁹⁹ DZN
2.	1150155	Polypropylene Sand Bags (26" x 14") - 20 per set (Sand not Incl.)	\$49 ⁹⁹ SET OF 20 ★
3.	1150162	Fieldsaver Repair Tape, 3" x 60' Roll	\$59 ⁹⁹ EA



FIELD TARP STORAGE ROLLER COVER

- Heavy duty 22oz vinyl
- Optional lettering available

1274066	3'T x 3'W x 20'L - used with 90' & 120' Tarps	\$294 ⁹⁹ EA
1274073	3'T x 3'W x 34'L - used with 160' tarps	\$389 ⁹⁹ EA
1274714	4.5' W x 40' L - used with 170' Tarps	\$479 ⁹⁹ EA
1298154	Lettering up to 24" Tall	\$57 ⁹⁹ EA



*THE 40' AND 34' TWO-PIECE ROLLER CONNECTS WITH PROVIDED HARDWARE AND REQUIRE CONNECTS HOLES TO BE DRILLED AFTER DELIVERY.

FIELD TARP STORAGE ROLLERS

- Heavy duty corrugated HDPE for tarp storage
- 2-piece rollers provide substantial savings on shipping cost
- Rollers are 28" in diameter

1158939	For 120' and 90' Tarps	\$899 ⁹⁹ EA	
1236781	For 160' Tarps	\$969 ⁹⁹ EA	
	For 170' Tarps	\$1,799 ⁹⁹ EA	



BP ZONE® BATTING PRACTICE TURF PROTECTORS

- Tough 20 mil. VIPOL® Matrix Mesh provides the highest level of spike protection for turf
- Same material as used by top high schools, NCAA, Major League Baseball and NFL teams
- All edges are hemmed and grommeted
- Complete set includes 8' x 14' blanket, 2 piece cage collar, two -12' x 14' blankets for fungo areas and a 20'W x 20'D x 60' across trapezoid shaped infield protector
- Available in 20 colors - see color bar below
- Chroma-Bond® imprinting available and sold separately

1159899	Complete Set	\$1,799 ⁹⁹ SET	
1159905	2 Piece Cage Collar Only	\$799 ⁹⁹ PR	
1159912EA	Individual 8' x 14' Turf Mat	\$139 ⁹⁹ EA	
1159929EA	Individual 12' x 14' Turf Mat	\$199 ⁹⁹ EA	
1159837	20'W x 20'D x 60'L	\$869 ⁹⁹ EA	



BP ZONE® PREMIUM TURF PROTECTOR

- Made of spike resistant 20 mil VIPOL® Matrix Mesh
- Perimeter edges are hemmed and grommeted
- 20 standard colors: see color bar
- Chroma-Bond® multicolor imprinting is available

1159806	20'W x 15'D x 50'L	\$729 ⁹⁹ EA
1159837	20'W x 20'D x 60'L	\$869 ⁹⁹ EA
1159868	20'W x 25'D x 70'L	\$969 ⁹⁹ EA

PRACTICE AND PREMIUM TURF PROTECTORS AVAILABLE IN:

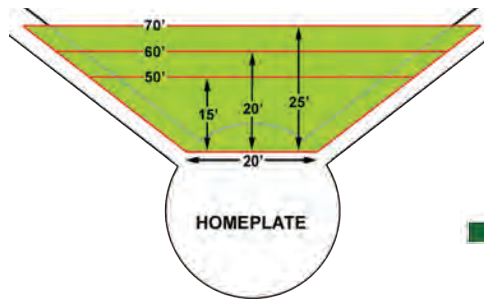
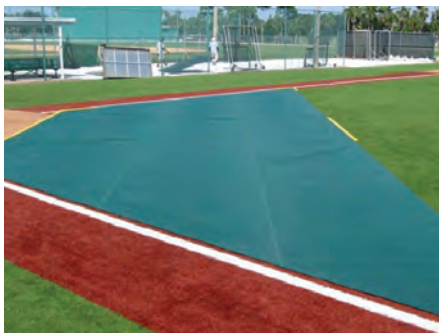

BP ZONE® BASICTURF PROTECTOR

- Constructed of varsity level 9 oz. mesh material
- Perimeter edges are hemmed and grommeted

1273892	20'W x 15'D x 50'L	\$399 ⁹⁹ EA
1273908	20'W x 20'D x 60'L	\$499 ⁹⁹ EA
1273915	20'W x 25'D x 70'L	\$699 ⁹⁹ EA

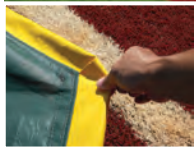

**WIND WEIGHTED INFIELD PROTECTOR
20'W X 15'D X 50'L**

- Protects both artificial and natural grass WITHOUT STAKES to hold it down.
- Steel chain inserted in vinyl sleeves in front, corners and back middle provide ballast that keeps the protector in position even in high winds.
- No stakes are required so installation and removal are easy.
- Made from tough 20 mil. VIPOL Matrix Mesh
- Choose from 20 colors!
- Chroma Bond imprinting is sold separately.

2 Year Limited Warranty

1323535	Size - 20'W x 15'D x 50'L	\$799 ⁹⁹ EA
1323542	Size - 20'W x 20'D x 60'L	\$899 ⁹⁹ EA
1323559	Size - 20'W x 25'D x 70'L	\$999 ⁹⁹ EA



FIELD WEIGHT & TARP CART

- Designed to transport area tarps and field weights
- Includes 1 set of 36 field weights
- Heavy duty, powder coated steel construction
- 2 large pneumatic turf tires
- Tow bar and wheel barrow handles
- Fits thru a standard door

1373617	\$1,439 ⁹⁹ EA	
---------	--------------------------	--

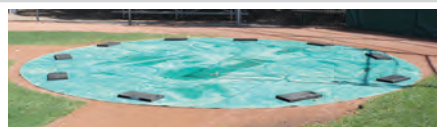

FIELD WEIGHTS (SET OF 4)

- The perfect alternative to sand bags
- Features an easy grip handle
- Durable so they won't tear and leave a sandy mess

1373618	7 lbs each - 28lbs.	\$114 ⁹⁹ SET
---------	---------------------	-------------------------



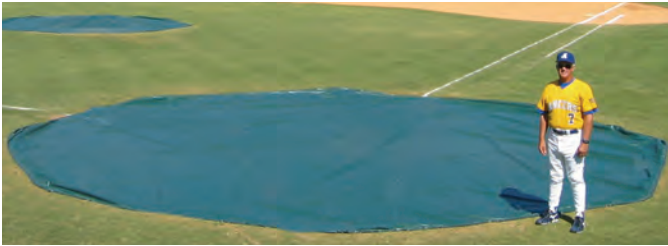

WIND WEIGHTED FIELD TARPS

- Famous Rain covers that stay put without stakes or sandbags
- Steel chain in edge hem allows these tarps to stay down even in high winds
- Field proven to 65mph.
- Industrial 18oz. vinyl-polyester fabric with UV and mildew inhibitors
- Major League Style, rounded to fit inside dirt circle for extended use in sun and for optimum dirt moisture management

2 Year Limited Warranty

1323573	12' Diameter	\$454 ⁹⁹ EA
1323580	18' Diameter	\$694 ⁹⁹ EA
1323597	20' Diameter	\$794 ⁹⁹ EA
1323603	26' Diameter	\$999 ⁹⁹ EA
1323610	30' Diameter	\$1,289 ⁹⁹ EA
1323627	10' x 10' Square	\$339 ⁹⁹ EA

Repair Kit for Weighted Wind Tarps

1162974	2 sq. yards of fabric and PVC Cement.	\$94 ⁹⁹ EA
---------	---------------------------------------	-----------------------



INSTALLER™ DEVICE FOR WIND WEIGHTED® TARPS

- Allows two people to cover a mound in less than 30 seconds!
- PVC-aluminum pipe design with handle at each end for carrying and a second handle at end of 5' stainless steel aircraft cable for pulling
- Makes tarp storage, installation, and take-up a breeze

1162271	12' Diameter Tarp - Weight: 40 lbs	\$329 ⁹⁹ EA
1162288	18' Diameter Tarp - Weight: 54 lbs	\$429 ⁹⁹ EA
1162295	20' Diameter Tarp - Weight: 61 lbs	\$449 ⁹⁹ EA
1162301	26' Diameter Tarp - Weight: 76 lbs	\$519 ⁹⁹ EA
1162967	30' Diameter Tarp - Weight: 85 lbs	\$569 ⁹⁹ EA

BUNT ZONE® INFIELD PROTECTOR/TRAINER

- Widely accepted as the best bunt training aid, it teaches by visualization the correct placement of bunts for hit (yellow) or sacrifice (green). Avoid red pitcher's triangle.
- Highly spike-tolerant 9 oz. industrial vinyl-polyester mesh with UV and mildew inhibitors
- Complete with brass grommets and low profile ground stakes

1236798	Major League - 20'D x 24' x 64'	\$999 ⁹⁹ EA
1236811	Major League - 15'D x 24' x 54'	\$939 ⁹⁹ EA
1236804	Major League - 15'D x 18' x 48'	\$759 ⁹⁹ EA
1162240	Minor League - 20'D x 24' x 64'	\$999 ⁹⁹ EA
1162257	Minor League - 15'D x 24' x 54'	\$869 ⁹⁹ EA
1162264	Minor League - 15'D x 18' x 48'	\$739 ⁹⁹ EA



VARSITY GRADE FIELD COVERS

- Composed of 5 oz woven polyethylene
- Super light, waterproof and mildew resistant
- Heat-sealed seams and double sewn reinforced perimeters
- Brass grommets spaced every 3'
- Ground stakes included with all covers
- Color: Green

1150575	Complete Set (1 x 26'; 1 x 20'; 3 x 10')	\$599 ⁹⁹ SET ★
1150544	26' Circular Home Plate Cover	\$359 ⁹⁹ EA ★
1150551	20' Circular Pitcher's Mound Cover	\$259 ⁹⁹ EA ★
1150568	10' Square Base Covers	\$189 ⁹⁹ SET ★

COLLEGIATE GRADE FIELD COVERS

- Composed of 14 oz vinyl
- Heat-sealed seams and double sewn reinforced perimeters
- Brass grommets spaced every 3'
- Ground stakes included with all covers
- Color: Royal Blue

2 Year Limited Warranty

1149722	Complete Set (1 x 26'; 1 x 20'; 3 x 10')	\$1,109 ⁹⁹ SET ★
1149685	30' Circular Cover	\$734 ⁹⁹ EA ★
1149692	26' Circular Cover	\$564 ⁹⁹ EA ★
1149708	20' Circular Cover	\$374 ⁹⁹ EA ★
1149715	10' Square Base Covers	\$339 ⁹⁹ SET ★



MAJOR LEAGUE

MINOR LEAGUE

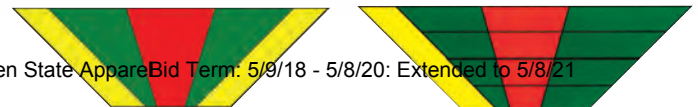

TURF BY THE ROLL

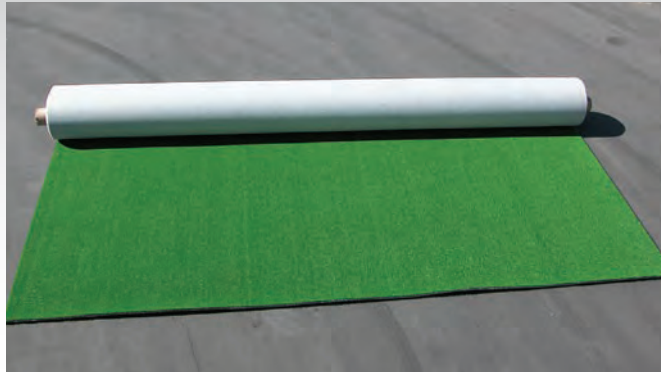

STANDARD BATTING TUNNEL TURF ROLLS

- Cover your batting tunnel floor with our DiamondTurf
- Available in **unitary** (with no foam padding) or **2mm foam backing**
- Rolls are 15'W x 70'L

TUNTRF1	36 oz. Turf with Unitary Backing	\$3,499 ⁹⁹ ROLL	
TUNTRF2	42 oz. Turf w/2mm Foam Backing	\$4,299 ⁹⁹ ROLL	

Cover your batting cage floor with one of our high quality Diamondturf products. We offer several grades of turf and backing to satisfy every budget and the turf can be glued down, but it is not necessary due to the size and weight of the material.

WE RECOMMEND A HITTING MAT FOR THE HOME PLATE AREA.



ACTION 35 DIAMONDTURF

- Top quality nylon turf, will hold up to most steel cleat traffic
- Turf is 35 oz., 1/2" pile height with a unitary, carpet style backing
- Hitting mat is recommended in the home plate area

1341966	By the square foot	\$3 ³⁴ SQ.FT	
1323900	15'W x 55'L Roll	\$2,299 ⁹⁹ ROLL	
1323917	15'W x 70'L Roll	\$2,899 ⁹⁹ ROLL	



SUPREME 36 DIAMONDTURF

- Top quality turf, will hold up to moderate steel cleat traffic
- Turf is 36 oz., 1/2" high pile with a 5mm foam backing
- Hitting mat is recommended in the home plate area

1235869	By the square foot	\$4 ⁹⁹ SQ.FT	
1323887	12'W x 55'L Roll	\$2,750 ⁰² ROLL	
1323894	12'W x 70'L Roll	\$3,449 ⁹⁶ ROLL	

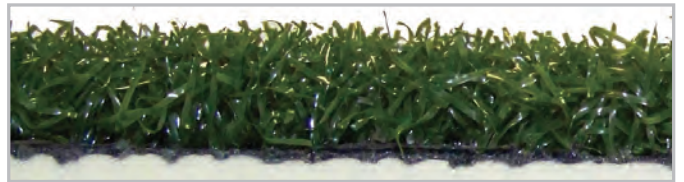

ACTION PLUS 35 DIAMONDTURF

- Top quality nylon turf, will hold up to moderate steel cleat traffic
- Turf is 35 oz., 1/2" pile height with a 5mm foam backing
- Hitting mat is recommended in the home plate area

1341997	By the square foot	\$4 ⁹⁴ SQ.FT	
1341973	15'W x 55'L Roll	\$3,599 ⁹⁹ ROLL	
1341980	15'W x 70'L Roll	\$4,499 ⁹⁹ ROLL	



DELUXE DIAMONDTURF

- Very good quality turf, will hold up to some steel cleat traffic
- Turf is 24 oz., 11/32" pile height with a 5mm foam backing
- Hitting mat is recommended in the home plate area.

1235876	By the square foot	\$4 ²⁴ SQ.FT	
1323863	12'W x 55'L Roll	\$2,449 ⁹⁹ ROLL	
1323870	12'W x 70'L Roll	\$2,950 ⁰⁰ ROLL	

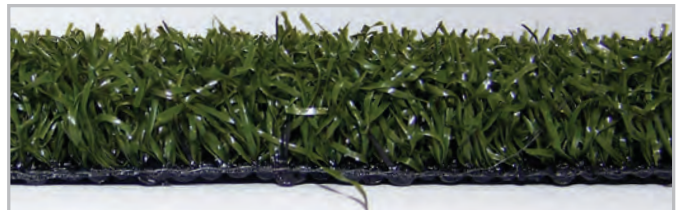

ELITE 45 DIAMONDTURF

- Best quality nylon turf, will hold up to some steel cleat traffic
- Turf is 45 oz., 5/8" pile height with a unitary, carpet style backing
- Hitting mat is recommended in the home plate area

1342024	By the square foot	\$3 ⁶⁴ SQ.FT	
1342000	15'W x 55'L Roll	\$2,549 ⁹⁹ ROLL	
1342017	15'W x 70'L Roll	\$3,199 ⁹⁹ ROLL	



STANDARD DIAMONDTURF

- Good quality turf, not designed for steel cleat traffic
- Turf is 25 oz., 5/16" pile height with a 3mm foam backing
- Economical option for a batting cage when a hitting mat is used in the home plate area

1235883	By the square foot	\$3 ⁹⁹ SQ.FT	
1323849	12'W x 55'L Roll	\$1,900 ⁰⁰ ROLL	
1323856	12'W x 70'L Roll	\$2,500 ⁰¹ ROLL	

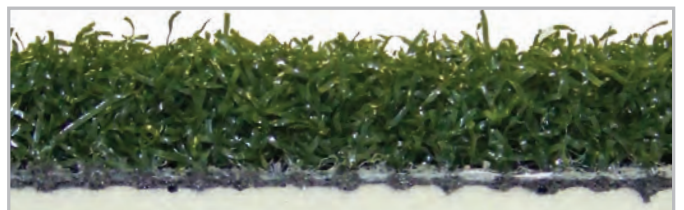

ELITE PLUS 45 DIAMONDTURF

- Best quality nylon turf, will hold up to some steel cleat traffic
- Turf is 45 oz., 5/8" pile height with a 5mm foam backing
- Hitting mat is recommended in the home plate area

1342055	By the square foot	\$5 ³⁴ SQ.FT	
1342035	15'W x 55'L Roll	\$3,799 ⁹⁹ ROLL	
1342048	15'W x 70'L Roll	\$4,799 ⁹⁹ ROLL	

TURF MATS

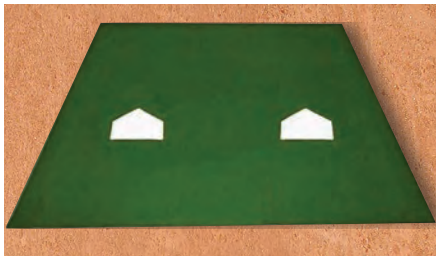

DIAMONDTURF BULLPEN MAT

- Comes with 2 side-by-side home plates
- Standard turf green only

1235944	12' x 12' - Weight: 135 lbs	\$799 ⁹⁹ EA	
---------	-----------------------------	------------------------	--

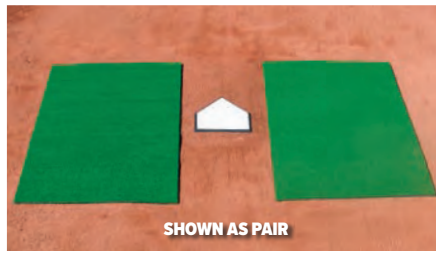

SHOWN AS PAIR

DIAMONDTURF BATTER'S MATS

- Standard turf green only

1235951	Baseball - 4' x 6' - Weight: 22 lbs.	\$239 ⁹⁹ EA
1235968	Softball - 3' x 7' - Weight: 20 lbs.	\$199 ⁹⁹ EA

HOME PLATE MATS!



CLAY

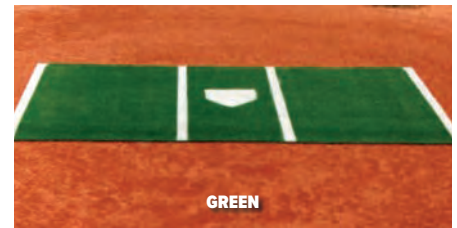

GREEN

HOME PLATE MATS

- For indoor/outdoor cages and on-the-field BP
- Will hold up to moderate spike-cleat traffic.
- Features a thick foam backing with inlaid white turf lines
- Comes with a heavy-duty throwdown home plate

1235890	Baseball (Clay) - 6' x 12'	\$484 ⁹⁹ EA	
1235906	Baseball (Green) - 6' x 12'	\$484 ⁹⁹ EA	
1235913	Softball (Green) - 7' x 12'	\$524 ⁹⁹ EA	



GREEN, BLACK, ROYAL, RED, YELLOW, ORANGE, CLAY & WHITE

DIAMONDTURF 6' ON-DECK CIRCLE

- Weight: 40 lbs per pair

1235975	Green	\$479 ⁹⁹ PR
1323436	Please Specify Color	\$484 ⁹⁹ PR



DIAMONDTURF PITCHER'S MATS

- Standard turf green only

1235920	4' x 12' - Weight: 30 lbs	\$334 ⁹⁹ EA
1235937	6' x 12' - Weight: 58 lbs	\$399 ⁹⁹ EA

BP MAT WITH CATCHERS EXTENSION

- Attached with a six-foot-long sewn-on Velcro strip
- Velcro on both sides of the extension so the mat can be rotated for maximum use and minimum wear
- Heavy duty design will hold against a batter's twisting
- Easily rolled up and stored

1373619	Green	\$599 ⁹⁹ EA
1373620	Clay	\$599 ⁹⁹ EA



DIAMONDTURF HALO MATS

- Made from spike proof DiamondTurf
- Eliminates turf replacement and the need for constant maintenance around home plate
- Kits come pre-cut to fit a 13' radius from the rear point of home plate
- Requires a concrete or asphalt base under turf
- Comes with either a unitary (carpet without padding) backing or with a 5mm foam pad backing
- Green turf only

1347074	5' Halo Kit without wings (unitary backing)	\$5,299 ⁹⁹ EA	
1347081	5' Halo kit with wings (unitary backing)	\$5,899 ⁹⁹ EA	
1347098	10' Halo Kit without wings (unitary backing)	\$6,299 ⁹⁹ EA	
1347104	10' Halo Kit with wings (unitary backing)	\$8,499 ⁹⁹ EA	
1347111	5' Halo Kit without wings (foam pad backing)	\$6,199 ⁹⁹ EA	
1347128	5' Halo Kit with wings (foam pad backing)	\$6,599 ⁹⁹ EA	
1347135	10' Halo Kit without wings (foam pad backing)	\$7,999 ⁹⁹ EA	
1347142	10' Halo Kit with wings (foam pad backing)	\$8,799 ⁹⁹ EA	
1347159	1 Color Letter in 5' halo	\$129 ⁹⁹ EA	
1347166	2 Color Letter in 5' halo	\$199 ⁹⁹ EA	
1347173	1 Color Letter in 10' halo	\$274 ⁹⁹ EA	
1347180	2 Color Letter in 10' halo	\$384 ⁹⁹ EA	



2-COLOR LETTERING ON 10' HALO KIT WITH WINGS

JOX BOX

(PHOTOS SHOW JOX BOX PRIOR TO INSTALLATION)

Eliminates holes in batter's boxes, in pitcher's area, and in front of bases. After proper installation, the Jox Box is low maintenance. Durable design resists steel cleats and is waterproof. Your field material is brushed into surface after installation to create a smooth transition. All are shipped motor freight.

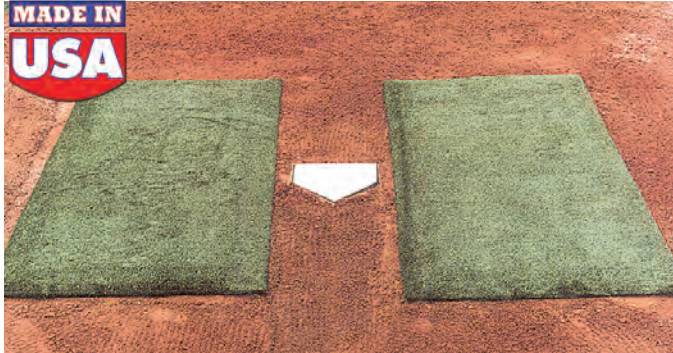

BATTERS BOX

- Eliminates holes in batters boxes, in pitcher's area, and in front of bases
- After proper installation, the Jox Box is low maintenance
- Durable design resists steel cleats and is waterproof
- Size is 4' x 8' overall, 3' x 7' exposed after installation

1235814 Set of 2 **\$1,399⁹⁹** PR



DELUXE BATTERS BOX

- Covers the entire homeplate area with a cut-out for homeplate
- Made in 2 pieces that butt together when installed

1235838 Youth Size 7' x 9', Weight: 550 lbs **\$1,599⁹⁹** EA 
 1235821 Full Size 8' x 10', Weight: 550 lbs **\$1,699⁹⁹** EA 



BASEBALL PITCHERS WEDGE

- Single wedge shaped panel is 3'W at the front and 4' 9"W at the top and 5' 6"L
- To be installed in front of the pitcher's rubber
- Weight: 150 lbs.

1235845 **\$699⁹⁹** EA 



SOFTBALL PITCHERS MOUND

- Single 4' x 8' panel with a cut-out for the pitching rubber
- Weight: 200 lbs.

1235852 **\$749⁹⁹** EA 

BELOW SURFACE



BATTERS BOX FOUNDATION

- Recycled rubber mats
- Eliminates deep holes in box areas
- Bury under 3" - 4" of dirt or clay
- Sold in pairs

MK3240 Size - 32"L x 40"W x 3/4"D **\$379⁹⁹** PR

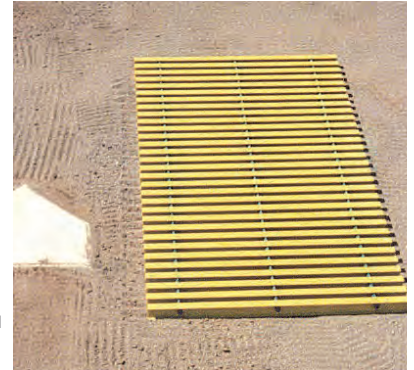

POWER MATS

- A non-conductive, non-corrosive, composite fiberglass construction
- Designed to be permanently buried in your batter's box 3" below grade
- Rigid design will not curl
- Eliminates dangerous holes created by "digging in"
- Shown prior to installation

1148817 Size - 32"W x 60"L **\$444⁹⁹** EA SHOWN PRIOR TO INSTALLATION

ABOVE SURFACE



GRATE GUARDS

- Cover your hazardous drainage grates and utility boxes with non-skid, recycled rubber covers
- Water flows through; approximately 3/4" thick
- Color: Dark Green only

1170467 Square Grate Guard - 37" x 37" **\$199⁹⁹** EA



DIAMOND PRO

CALL FOR FREIGHT QUOTE

BASEBALL/SOFTBALL



CALCINED CLAY TOP DRESSING

- A calcined clay product used on the skinned areas of baseball and softball fields to improve drainage
- The larger product size increases the durability of the product
- It will not stick to cleats and is easily incorporated into the infield
- 50 lb. bags/40 bags per pallet

DPROCCTD \$699⁹⁹ PALLET

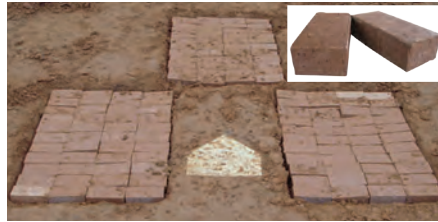

MOUND/HOMEPLATE CLAY BRICKS

- Mound/ Home plate clay bricks are unfired compressed clay bricks perfect for building or repairing high stress areas
- The bricks, when watered, simply turn to firm clay to provide durability and reduced maintenance in these areas
- Brick size: 4" x 8" x 2-1/2"
- 300 bricks per pallet

DPROB12 \$859⁹⁹ PALLET



RED INFIELD CONDITIONER

- A vitrified clay (expanded shale and clay) product applied to skinned areas of baseball and softball fields
- Red infield conditioner helps create a natural look that enhances the appearance of an infield
- 50 lb. bags/40 bags per pallet
- Bulk delivery is available upon request

DPROIC \$599⁹⁹ PALLET



ATHLETIC FIELD MARKING DUST

- Bright premium marking dust complies with the NCAA rules
- Non-toxic, non-burning and harmless to soil and turf
- 50 lb. bags/40 bags per pallet

DPROMD \$679⁹⁹ PALLET



MOUND/HOMEPLATE CLAY

- Mound/ Home plate clay is a screened clay loam with a rich red color, which easily conforms and binds to the existing surface
- The loose clay easily tamps into holes providing greater durability and less maintenance
- 50 lb. bags/40 bags per pallet

DPROCL \$659⁹⁹ PALLET



CALCINED CLAY DRYING AGENT

- A calcined clay product used to quickly dry puddles and muddy conditions
- The finer gradation has more surface areas to dry the field faster, reducing rain delays
- It will not stick to cleats and is easily incorporated into the infield
- 50 lb. bags/40 bags per pallet

DPROCDDA \$699⁹⁹ PALLET

LARGE STRING WINDERS

- High impact plastic reel
- 740' of heavy duty nylon twine
- 10" steel spike

1323443 Hand Held Model - Black \$49⁹⁹ EA
1323450 Caddy Model - Orange \$59⁹⁹ EA



LINE MATE STRING WINDER

- Lightweight, easy to use tool for layout and lining baseball/softball fields.
- Comes complete with permanent distance markers on cable, extra cord for foul lines, hammer and 2 spikes.
- Cable is 130', cord 240', distance marks at 45', 60', 90', 127' 3-3/8"

1297607 Orange Pro Model \$199⁹⁹ EA



HAND HELD STRING WINDER

- Durable ABS case keeps the string fully enclosed to prevent damage
- Wound by one person
- The nail stores on the side of the unit for safety
- Comes with 450' of durable nylon twine

1265804 \$39⁹⁹ EA ★

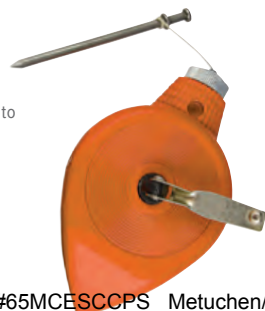

CLEAT AND SPIKE CLEANER

- Durable molded PVC construction
- UV protected to withstand outdoor conditions
- Extended side panel
- Built in handle for easy transport

1186796 19" x 14" \$49⁹⁹ EA ★



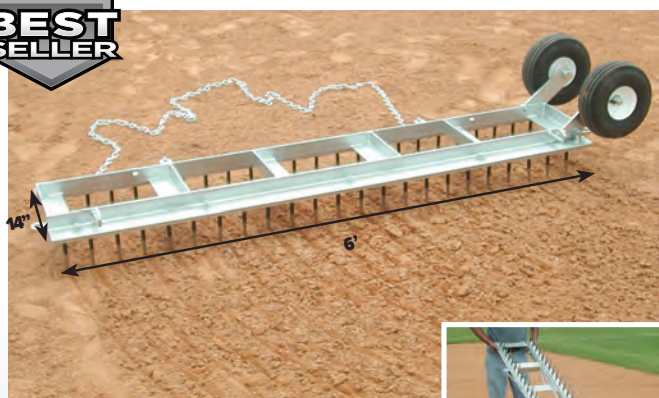

DIAMOND DIGGER FIELD GROOMER

- Hot dipped galvanized steel frame
- Uses 4.5" sharpened and hardened steel cutting teeth
- No-flat wheels allow you to roll for transport
- Pull chain is provided
- Hooks on rear allows for attachment of drag mat
- Remove wheels to turn groomer over and use as a leveling sled
- Recommended to be pulled by a tractor



BSDDRAG	Diamond Digger w/Wheels, Wt 100 lbs.	\$569 ⁹⁹ EA ★	S&H
BSDDWHL	Set of 2 Wheels	\$179 ⁹⁹ EA ★	
1275216	Repl. Teeth for Diamond Digger	\$129 ⁹⁹ PACK ★	

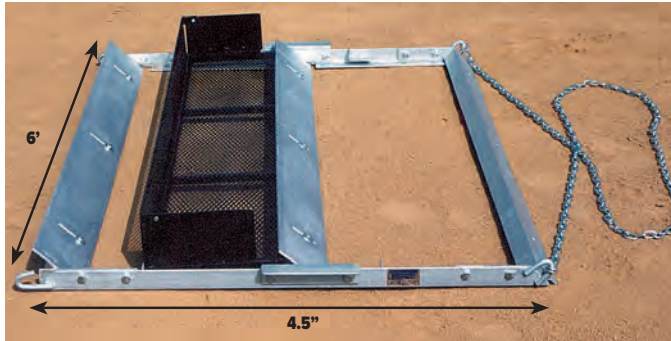

CUT N' LEVEL DRAG

- The Cut-N-Level drag is designed for grooming the surface of playing fields
- Features flat steel cutting blades and a screen for rock removal
- Made from 16 gauge metal, the cutting blades are slotted and attached to the main frame with bolts, allowing the operator to adjust the blades for the desired depth of cut
- Used in routine maintenance, the Cut-N-Level drag can be used for rock removal, smoothing and leveling the field as the need arises, saving hundreds of man-hours normally needed to do these jobs
- Frame and blades are galvanized
- Weight: 220 lbs.

BSCLDRAG	Size - 6"W x 4'6"L	\$999 ⁹⁹ EA ★	S&H
-----------------	--------------------	--------------------------	----------------



BUY THE COMBO AND SAVE!

DIAMOND DIGGER FIELD GROOMER - COMBO

- Purchase the Diamond Digger together with our Heavy Duty drag mat (1149821) and save

BSDDRAGC	Complete Combo	\$699 ⁹⁹ EA ★	S&H
-----------------	----------------	--------------------------	----------------



5' X 3' PREMIUM NAIL DRAG

- Welded steel frame supports 117 - 6" L x 1/4" D grooming nails
- Wheels and tongue make moving and storing these units easy
- Comes complete with 6'W x 18"L rigid drag mat
- All attachments, hardware and pull chains are included
- Frame size 5' x 3'. Weight: 120 lbs.

BS53DRAGC	Nail Drag w/ Rigid Drag Mat (shown)	\$994 ⁹⁹ EA ★	S&H
BS53DRAG	Nail Drag w/ Drag Chain only	\$884 ⁹⁹ EA ★	S&H
BS53NAIL	Replacement Nails (pack of 117)	\$99 ⁹⁹ EA	

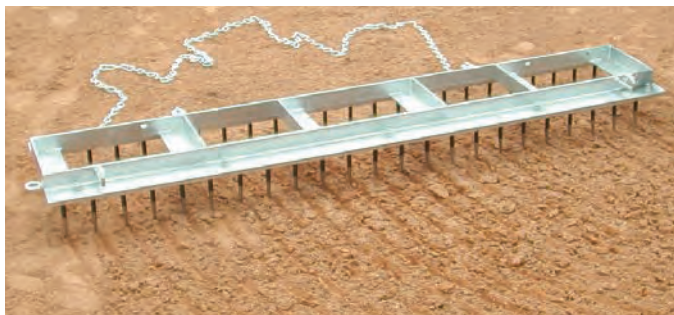

BIG LEAGUE FIELD DRAG

- Designed to break up dirt or cinders on the baseball field or track
- Features forty-six 4.5" steel cutting teeth
- Frame is hot dipped galvanized steel
- Heavy duty pull chain included
- Recommended to be pulled by a tractor
- Grooming drag chain included
- Flip over and use as leveling drag
- Weight : 88 lbs.



BSDRAG	Size - 14"W x 6'L	\$454 ⁹⁹ EA ★	S&H
---------------	-------------------	--------------------------	----------------



NEW STRIPE

DIRT MEDIC WITH BRUSH

- Break-up packed surface and level ridges and ruts
- Can be towed with garden tractors, ATV's or light utility vehicles
- Weighs less than 200lbs.

1378377	32"W x 62"L x 36"H	\$1,999 ⁹⁹ EA	S&H
----------------	--------------------	--------------------------	----------------

Bid #ESCNJ 17/18-31

Educational Services Commission of New Jersey

Athletic Equipment & Supplies

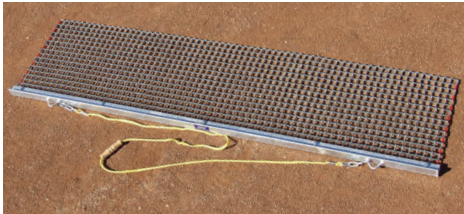

RIGID DRAG MATS

- Rugged all-steel drag mats have 1" x 1" mesh with 13 gauge galvanized connecting rods
- Mesh material is 3/8" x .050 galvanized steel
- Cannot be rolled up for storage
- Includes heavy-duty angle iron across front of mat and a rope with handle for pulling

DMATR6X3	6'W x 3'L, Wt 44 lbs.	\$289 ⁹⁹ EA ★
DMATR6X18	6'W x 18"L Weight: 35 lbs.	\$199 ⁹⁹ EA ★
DMATR4X3	4' W x 3' L, Weight: 36 lbs.	\$234 ⁹⁹ EA ★
DMATR4X18	4'W x 18"L Weight: 24 lbs.	\$179 ⁹⁹ EA ★

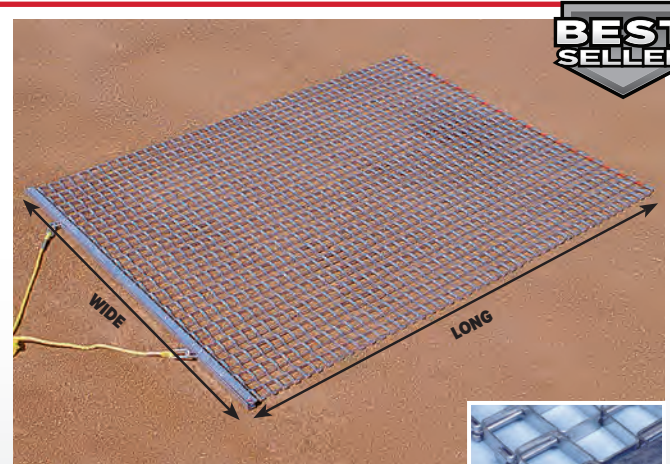

ALL-STEEL DRAG MATS

- Workhorse, all-steel drag mat comes complete with drag bar and pull rope
- Mesh material is 3/8" x .050 galvanized steel
- Perfect for general grooming and maintenance

DMAT3X5	Size - 3'W x 5'L - Weight: 28lbs.	\$189 ⁹⁹ EA ★
DMAT3X4	Size - 3'W x 4'L Weight: 23lbs.	\$159 ⁹⁹ EA ★
DMAT6X3	Size - 6'W x 3'L Weight: 38lbs.	\$249 ⁹⁹ EA ★
DMAT6X6	Size - 6'W x 6'L Weight: 64lbs.	\$369 ⁹⁹ EA ★
BBMAT106	Size - 10'W x 6'L Weight: 97 lbs.	\$499 ⁹⁹ EA ★ S&H



COCOA DRAG MATS

- Constructed from natural cocoa fibers that "float" across the surface producing a beautiful finish with minimal buildup of your infield mix
- Solid-steel twin blade cutting edge to level rough spots
- Great on turf to break up core aeration plugs and smooth in top-dressing materials
- Handle grip for easy transport

1091540	Standard Cocoa Drag - 4' x 2'	\$269 ⁹⁹ EA
1091557	Large Cocoa Drag - 6' x 2'	\$309 ⁹⁹ EA
1091564	Jumbo Cocoa Drag - 6' x 4'	\$414 ⁹⁹ EA

6' CUTTING BAR (WITH DRAG)

- Unique 6' asymmetrical cutting bar levels & smooths rough spots and eliminates ridge build-ups
- The cutting bar is sized to match our 6' x 6' drag mats
- Includes quick-link attachments
- Combo unit includes cutting bar and 6' x 6' drag (DMAT6X6)

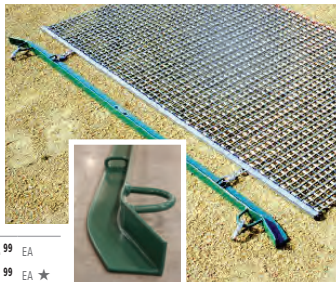

1237009	Cutting Bar only	\$174 ⁹⁹ EA
1273410	Cutting Bar w/drag combo	\$499 ⁹⁹ EA ★

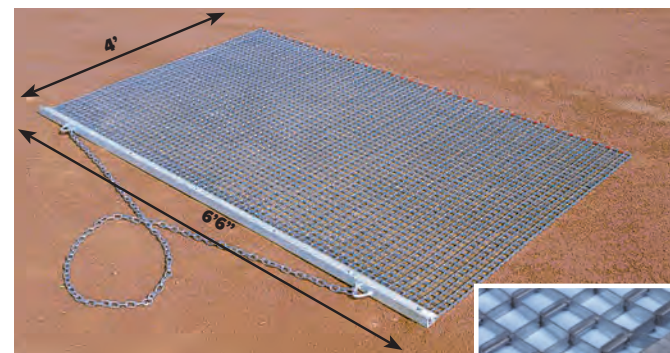

HEAVY DUTY DRAG MAT

- Mesh is 3/8" x .050 galvanized steel
- Includes heavy duty angle iron across front of mat and a heavy duty chain for tractor pulling
- Weight: 68 lbs.

1149821	Size - 6'6"W x 4'L	\$399 ⁹⁹ EA ★
----------------	--------------------	--------------------------



HAND NAIL DRAG

- Ideal for scarifying baselines, cutouts and home plate areas, as well as daily nail dragging of infield skin
- Constructed of plastic lumber and hardened 1/4" steel spikes and can be pulled in either the 3'W or 2'W direction by simply changing the tow rope connection point
- Pull rope included

1236996	Size - 3' x 2'	\$399 ⁹⁹ EA
----------------	----------------	------------------------

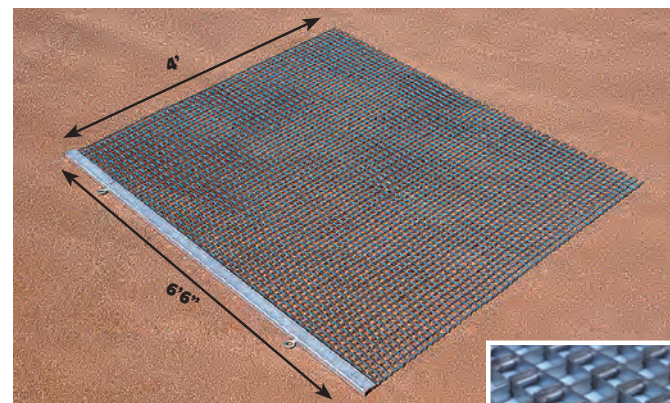

MONSTER DRAG MAT

- Deluxe mat construction utilizes 1/2" x .062 mesh with 6 gauge connecting rods, each welded on end
- Includes angle iron front with welded eye bolts to attach your

1159608	Size - 6'W x 4'L	\$449 ⁹⁹ EA ★
----------------	------------------	--------------------------

BASEBALL/SOFTBALL



TAMP

- Tamp base is made of 1/2"-thick steel plate
- Covers a 12" x 12" area
- Heavy duty 48" steel handle

BBTAMPBM \$89.99 EA ★

TAMP COVER

- Designed to make tamping wet clay a simple, hassle free process as the cover does not allow wet dirt to stick to the tamp plate.
- Fits 12" x 12" tamp.

1088137 \$39.99 EA



INFIELD FINISHING MOPS

- Designed for those small areas that are nearly impossible to finish grooming
- Great for pitching mounds, batters boxes, base paths, on-deck circles, and any other cutouts
- 2'W x 18"D mats are available in your choice of either a high quality cocoa mat or super-duty flexible steel mat.
- 66" handles & other components are constructed from heavy-duty reinforced aluminum.

1091533	Flex Steel Mop	\$179.99 EA
1091526	Cocoa Mop	\$194.99 EA



DOUBLE-PLAY MONSTER BROOM

- This massive 84" broom has an aggressive scarifying edge for breaking up packed soils while the broom gives your playing surface a professional look.

200182384 \$299.99 EA

THREE-ROW MONSTER BROOM

- 7" broom is excellent for dressing softball or baseball infields
- May also be used for sweeping warehouse floors, tennis courts and pavement
- Made with heavy-duty aluminum construction

BBDRGBRM \$279.99 EA

ECONOMY HAND WATER PUMP

- Removes water quickly at 8 - 10 gallons per minute
- 36"H x 1-3/4"D pump with 6'L x 1-1/4"D outlet hose
- Made from high-impact PVC

1242324 \$74.99 EA



DIAMOND PUMP

- Pump puddles away at 18-20 gallons per minute with this amazing non-clogging hand pump
- Needs 2" of water to be most efficient but will draw water down to less than 1/2"

BBDMDPMP	Complete unit	\$154.99 EA
BBDMD50H	50' Hose Attachment	\$139.99 EA

PUDDLE PILLOW

- The Puddle Pillow is a reusable, lightweight pillow that can absorb up to 3.5 liters of water from puddles
- Place the pillow in standing water, remove from the area and squeeze out the absorbed water.

20026531 \$139.99 CASE OF 10



SUPER SOPPER

- Pick up water & carry it away from playing surface
- For grass, tennis courts or artificial turf

BBSMCKR \$999.99 EA
BBSLDLPH 14 gallon holding tank \$1,099.99 EA



LEVELING BOARD

- 54" width
- Ideal for levelings infield, bases, home plate & pitchers mound
- Leaves smooth finish on wet or dry field
- Heavy duty aluminum handle
- Steel cutting edge for filling high & low spots.

1149005 \$214.99 EA ★

Bid #ESC NJ 17/18-31

Educational Services Commission of New Jersey

Athletic Equipment & Supplies

INFIELD LIP BROOM

- Heavy duty 28" broom head with two rows of replaceable bristles and 5' powder-coated aluminum handle, bent to reduce back strain
- Ideal for brushing top-mix out of turf
- Use back side to scrape and break-up hard dirt

1148497 Size - 28"W \$154.99 EA

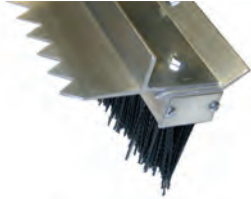

LOOP HOE EDGER

- Double knife edge rocks back and forth with a push/pull motion
- Excellent for cultivating, aerating and weeding
- Replaceable blade
- 60" powder-coated aluminum handle
- 6" non-slip vinyl grip

1184716 \$54.99 EA



ALUMINUM MAINTENANCE RAKE

- All aluminum construction
- Durable and lightweight with oversized teeth for easy field grooming & pit maintenance
- Use one side to rake and the other side to level
- 58" long handle

1196238 Size - 24"W \$64.99 EA ★
 1196245 Size - 36"W \$74.99 EA ★
 1196252 Size - 48"W \$84.99 EA ★



BREAKS DOWN FOR EASY STORAGE!



BASERUNNER RAKE

- Heavy duty rake has a telescopic handle that adjusts from 39" to 70" and breaks down for convenient storage
- The high grade aluminum head was designed specifically for the sports turf industry

200112503 Size - 36"W \$119.99 EA



OVERSEED ENHANCING TOOL

- 12 self-sharpening steel star wheels penetrate any compacted soil
- Perfect for overseeding wear areas on your field
- Creates excellent seed-to-soil contact, critical for successful germination
- 9"W head w/60" steel handle.

1149012 \$59.99 EA ★



PRO LUTE RAKE

- Saw-tooth design makes this tool ideal for breaking-up and grading soil and top dressing
- Magnesium/aluminum head with strong wrap around bracing
- 82" powder-coated handle connected to head with solid metal plug

BBFLDLTE Size - 36"W \$99.99 EA
 1237016 Size - 30"W \$94.99 EA



SIFTING SCOOP SHOVEL

- Perfect tool for cleaning rocks, glass and unwanted debris from dirt and sand
- Lightweight one piece molded construction
- Scoop head is 18" wide

1273922 \$99.99 EA



MOUND SLOPE GAUGE

- This popular mound building tool is the most accurate way to ensure proper height and taper
- Includes bubble level, metal ruler, 2 support rods and complete instructions for mound construction and

1148992 \$289.99 EA

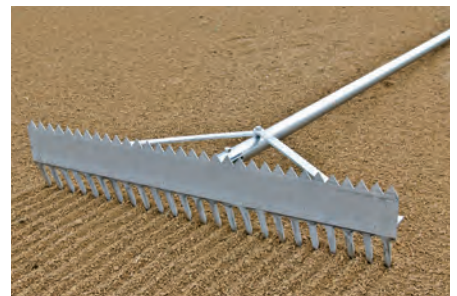

DOUBLE PLAY INFIELD RAKE

- Short teeth break up the hard clay
- Longer teeth sift the top soil for general grooming

1234992 Size - 36"W \$99.99 EA ★

NJ State Approved Co-op #65MCECOPS Metuchen/Garden State Appar Bid Term: 5/24/18 - 5/8/20: Extended to 5/8/20

BASEBALL/SOFTBALL

SPRAY NOZZLES



1237108	Aluminum Spray Nozzle-Fits 1" hose	\$99 ⁹⁹ EA
1291292	Plastic-Fits 3/4" hose	\$64 ⁹⁹ EA

1342062	Flat/Stream Spray-Fits 1" hose	\$84 ⁹⁹ EA
1291278	Plastic-Fits 1" hose	\$74 ⁹⁹ EA

SHOWER HEAD NOZZLE

- Great tool for watering select areas
- Fits 3/4" or 1" hose
- Up to 55 GPM

K10598	\$34 ⁹⁹ EA
---------------	------------------------------



MAGNUM STEEL SPRAY NOZZLE

- Mist to stream pattern
- Delivers up to 30 gallons per minute
- Fits 3/4" and 1" hoses
- Adapter included

K10270	\$74 ⁹⁹ EA
---------------	------------------------------



QUICK COUPLER FIXTURE KIT (3/4" OR 1")

Includes quick coupler that attaches permanently to your 3/4" or 1" water line. Attach your water hose, the key handle and the brass swivel together. Insert the key handle into the quick coupler push down and turn to lock in and release the water through the hose. Reverse the procedure to turn the water off.

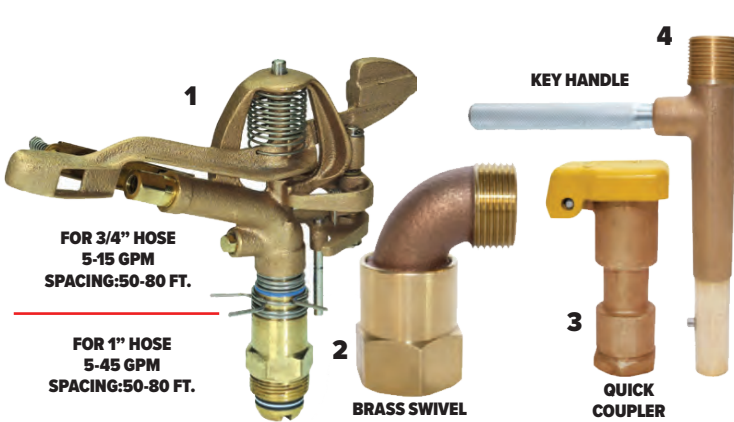

1	• Quick coupler, key handle and brass swivel	1376454	\$94 ⁹⁹ SET
		1376458	\$159 ⁹⁹ SET
2	• Extra brass swivel	1376456	\$34 ⁹⁹ EA
		1376460	\$39 ⁹⁹ EA
3	• Extra key handle for 3/4"/1" coupler	1376455	\$29 ⁹⁹ EA
		1376459	\$47 ⁹⁹ EA
4	• Attaches to key handle for use in quick coupler or roller pro portable sprinkler base	1376461	\$119 ⁹⁹ EA

HOSES



ENDURO HOSE REEL SYSTEM

- Heavy duty, powder coated steel construction
- Large 14" solid rubber wheels for smooth transport
- Includes a 1" x 6'L supply line hose
- Accommodates 150' of 1" hose
- Complete kit includes: Enduro Hose Reel, 1" x 100' Quick Wet Down Water Hose (1275179) and the 1" Aluminum Spray Nozzle (1237108)

MSHREEL2	\$499 ⁹⁹ EA
1275186	\$599 ⁹⁹ EA



1" BALL PARK HOSES AND KITS

- 1" I.D. heavy-duty clear hose is used by top level facilities throughout the country
- Handles 150 psi operating pressure and 600 lb. burst pressure
- Hose kit includes: hose, hose key, quick connect, spray nozzle and swivel

MSHOSE50	50' Hose Kit	\$589 ⁹⁹ EA
MSHOSE75	75' Hose Kit	\$599 ⁹⁹ EA
MSHOSE00	100' Hose Kit	\$699 ⁹⁹ EA
200101075	75' Hose Only	\$239 ⁹⁹ EA
200101100	100' Hose Only	\$299 ⁹⁹ EA



1" QUICK WETDOWN WATER HOSES

- Heavy duty rubber hose with solid brass couplings and stainless steel bands
- Top quality construction

1275162	75' Hose Only	\$199 ⁹⁹ EA
1275179	100' Hose Only	\$259 ⁹⁹ EA

3/4" MUNICIPAL WATER HOSES

- Same quality construction as the 1" hose except diameter is 3/4"

1275148	75' Hose Only	\$159 ⁹⁹ EA
1275155	100' Hose Only	\$194 ⁹⁹ EA

Bid #ESCNJ 17/18-31

Educational Services Commission of New Jersey Athletic Equipment & Supplies



4-WHEEL LINE MARKERS W/ PNEUMATIC TIRES

- The most durable line marker on the market
- 11 gauge steel frame
- 18 gauge galvanized steel bucket
- Tires measure 3.5"W x 10"D
- Easily adjustable to either 2" or 4" lines

18 Month Limited Warranty

1. BBHDDM10	100 lb. Capacity	\$369⁹⁹ EA ★
2. BBHDDM50	50 lb. Capacity	\$339⁹⁹ EA ★

4-WHEEL DRY LINE MARKER

- All steel construction
- 4 hard rubber wheels for extra durability
- Easily adjustable to either 2" or 4" lines

3. BBDLM654	4-Wheel 65 lb. Capacity	\$259⁹⁹ EA ★
--------------------	-------------------------	--------------------------------

2-WHEEL DRY LINE MARKER

- All steel construction
- 2 hard rubber wheels for extra durability
- Easily adjustable to either 2" or 4" lines

4. BBBLM252	2-Wheel 25lb. Capacity	\$174⁹⁹ EA ★
--------------------	------------------------	--------------------------------



FOLDABLE BATTER'S BOX TEMPLATES

- Lightweight aluminum frame template
- Simply line the handle up with the straight side edge of the plate and you will be square and the correct distance away from for proper alignment
- Step on template and leave a 2"W impression to chalk over
- Folds in half for easy transport

BBTMPL46	4' x 6' Baseball	\$299⁹⁹ EA ★
BSFTMPSB	3' x 7' Softball	\$299⁹⁹ EA ★
BSFTMPLL	3' x 6' Little League	\$299⁹⁹ EA ★



ADJUSTABLE BATTER'S BOX TEMPLATE

- Adjustable to 3' x 6' (youth league), 4' x 6' (big league), 3' x 7' (softball), 4' x 7' (softball)
- By positioning the two markers on either side of the plate and tracing the outside edge with a nail, you are ready to chalk
- All steel construction

BSTMPLA		\$299⁹⁹ EA ★
----------------	--	--------------------------------



STRIPING WAND

- Use for convenient touch-up of lines or stenciling
- Sturdy, lightweight construction
- Works with Mark1 field striping paint

1237092		\$74⁹⁹ EA
----------------	--	-----------------------------

ATHLETIC FIELD STRIPER

- For use on grass, dirt, concrete, pavement or gravel
- Sturdy steel construction with 4 large, easy rolling wheels and a collapsible handle for easy storage
- Lightweight housing includes windscreen, fingertip on/off lever, storage for 12 extra cans and simple 2" - 4" line width adjustment
- Non-toxic aerosol spray goes straight downward for complete coverage (paint sold separately)
- Maintenance free, no messy clean up



0795XXXX		\$144⁹⁹ EA
-----------------	--	------------------------------



FIELD STRIPING PAINT

- Our 3 main colors, White, Orange and Yellow will give you up to 700 feet of spray based on a 4" line
- Compare that with others that offer only 300-400 feet based on a 4" line. That's like getting 2 cans for the price of one
- Will not flake or wash away
- Cans are 20 oz. capacity and 17 oz. by weight

Case Price (12 Cans)

0792XXXX	White	\$67⁹⁹ CASE OF 12 CANS
0792ORXX	Orange	\$67⁹⁹ CASE OF 12 CANS
0792YLXX	Yellow	\$67⁹⁹ CASE OF 12 CANS
0792CXXX	Other colors - Standard Nozzle	\$82⁹⁹ CASE OF 12 CANS

3 Case Master (36 Cans) Save!!

0792PACK	White	\$169⁹⁹ PACK OF 36 CANS
0792CPACOR	Orange	\$169⁹⁹ PACK OF 36 CANS
0792CPACYL	Yellow	\$169⁹⁹ PACK OF 36 CANS
0792CPAC	Other colors - Standard Nozzle	\$199⁹⁹ PACK OF 36 CANS





PITCHERS PLATES

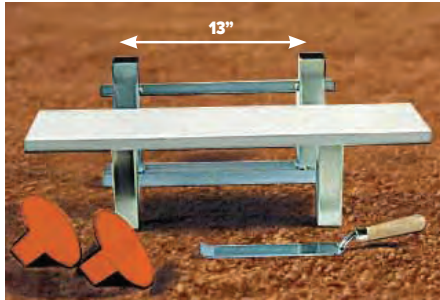

PROFESSIONAL REMOVABLE PITCHING RUBBER

- All steel ground anchor to be cemented into ground
- Pitcher's rubber is bolted and silicone-sealed to the top stanchion
- Comes with two rubber anchor plugs and an anchor digout tool

BSPIGP Official Size - 6" x 24" **\$174.99** SET ★

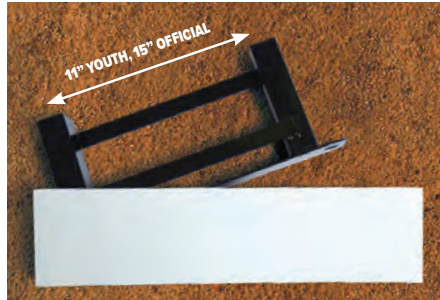

REMOVABLE PITCHER'S PLATE & ANCHOR

- Semi-permanent anchoring system
- Powder coated steel stanchion bolted to the pitcher's rubber

BSIGPPSR Complete Set - Official Size 6" x 24" **\$47.99** EA ★
1033434 Official Ground Anchor w/ Insert **\$29.99** EA ★
1033465C Complete Set - Youth Size 4" x 18" **\$39.99** SET ★
1033441 Youth Ground Anchor w/ Insert **\$29.99** EA ★



4-WAY PITCHER'S RUBBER

- Comes complete with inner support tubing
- Designed to be rotated periodically for extended life

BBPR4WAY Official Size - 6" x 24" **\$99.99** EA ★
BBPR4YTH Youth Size - 4" x 18" **\$84.99** EA ★



PITCHER'S RUBBER

- Solid white molded rubber
- Includes three metal spikes

BBPPLATE Official Size - 6" x 24" **\$19.99** EA ★
BBPPLLXXY Youth Size - 4" x 18" **\$17.99** EA ★



END SPIKED PITCHING RUBBERS

- Spikes go through steel tabs for easy installation
- Includes 4 spikes

1147902 Official Size - 6" x 24" **\$32.99** EA ★
1148466 Youth Size - 4" x 18" **\$19.99** EA ★
1148473 Extra Hammer Spikes **\$9.99** PACK OF 4 ★



STEP DOWN PITCHER'S RUBBER

- Wooden core with solid molded cover and front extension to prevent holes in the front of the plate and reduce maintenance
- No stakes or spikes required

BBPRPROX Official Size - 6" x 24" **\$84.99** EA ★
BBPRPROY Youth Size - 4" x 18" **\$74.99** EA ★

HOME PLATES

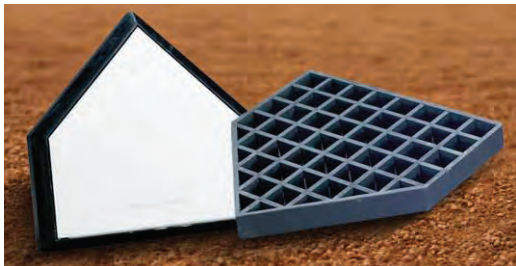

WAFFLE STYLE IN-GROUND HOME PLATE

- All rubber construction
- Waterproof with non-skid surface.

BBHPSAFW **\$74.99** EA ★

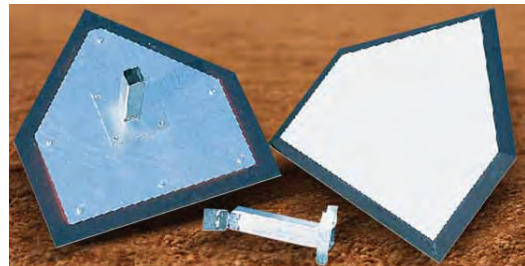

MAJOR LEAGUE HOME PLATE

- Beveled hard white rubber plate
- Includes anchor

BBHPHWODBM **\$99.99** EA ★

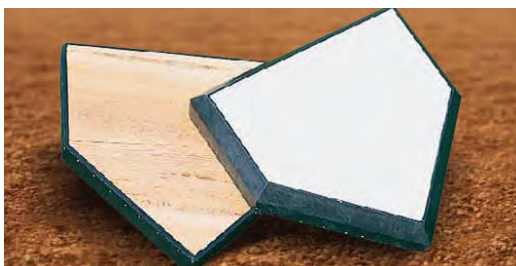

WOOD-FILLED HOME PLATE

- Full traditional solid wood filling for superior durability
- Beveled edges for safety

BBHPSAFE **\$99.99** EA ★



RUBBER HOME PLATE

- Solid white rubber with black beveled edges for safety

BBHPXXXXY **\$32.99** EA ★
BBHPSPIK Replacement Spikes **\$9.99** SET OF 5 ★

Bid #ESCNJ 17/18-31

Educational Services Commission of New Jersey

Athletic Equipment & Supplies

REC BASES



HEAVY DUTY VINYL BASES

- Inverted sewn seams for extra durability and double-thick-top for long lasting wear
- Outer cover is 100% nylon-impregnated vinyl
- Polyfoam inner core for maximum shape retention
- Packed 3 bases per set with 6 spikes

MCBASE55Y	Official Size - 15" x 15"	\$59⁹⁹ SET ★
MCBASE35Y	Youth Size - 14" x 14"	\$49⁹⁹ SET ★
BBSPIKES	Replacement Spikes	\$16⁹⁹ SET OF 6 ★

PRO BASES



"BOLCO" STYLE STRAPLESS BASES

- Made from rugged, bonded polyester padding that is tear-resistant and waterproof
- The base is easily bolted to its anchor plate
- Anchor plate contains metal sleeve for stability
- Base size - 15"L x 15"W x 3"H

BBBASEBOP	Set - 3 Bases, 3 Stakes & 3 Plugs	\$199⁹⁹ SET ★
BBBASEBO	Set - 3 Bases & 3 Stakes	\$194⁹⁹ SET ★
BBBASEBOEA	Single Base Only	\$72⁹⁹ EA ★
BBBOSPIK	Base Ground Stakes	\$9⁹⁹ SET ★



MAJOR LEAGUE BASES

- Heavy gauge white rubber cover over a high density foam interior and all welded steel stanchion pan - no bolts to come loose.
- This base is designed to reduce sliding injuries, it is not a substitute for proper sliding
- Base size - 15" x 15" x 3"

BBBASEPR	Set of 3 w/Ground Anchors	\$189⁹⁹ SET ★
BBBASEPX	Set (3)- w/o Ground Anchors	\$184⁹⁹ SET ★
BBBASEPP	Set (3)- w/Ground Anchors, Plugs	\$199⁹⁹ SET ★
1170757	Single Base Only	\$74⁹⁹ EA ★

SAFETY BASES



SHOCK ABSORBING BASES

- This cushioned base is uniquely designed to help reduce injury
- The base gives at the right time to absorb the brunt of the slide
- Durable, one-piece molded rubber base with no metal parts - No rust!
- Removable white center post for easy storage and replacement.
- Does not include anchors

BBBASRIC	Complete Set without Anchors	\$199⁹⁹ SET ★
BBDFBSTN	Replacement white center posts	\$19⁹⁹ SET OF 3 ★

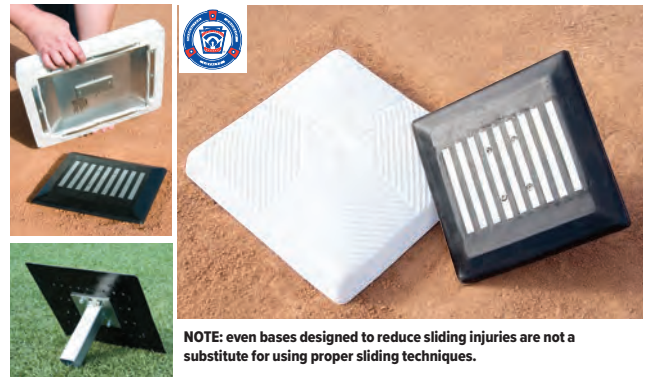

NOTE: even bases designed to reduce sliding injuries are not a substitute for using proper sliding techniques.

MAGNETIC SUPER BASE

LITTLE LEAGUE® APPROVED.

Reduce the risk of serious injury to sliding players with this unique base designed for all ages. According to Rule 1.06 of the Little League® rule book, Beginning in 2008, it has become mandatory that all leagues utilize bases that disengage their anchor.

Features:

- Bases release when the magnetic attraction between the base and magnetic fixture are overcome by excessive force from a short slide.
- 3 different plate sizes bolt to the bottom of the base pan to adjust the holding strength of the base to the anchor.
- Base cover has a ribbed surface design to reduce the risk of slipping.

BBMACMEG	Complete Base - 15" x 15" x 3"	\$229⁹⁹ EA ★
BBMNFIXT	Magnetic Base Fixture	\$184⁹⁹ EA ★
1185829	Replacement Base Cover and Pan	\$89⁹⁹ EA ★
BBANCHOR	Ground Anchors - 3/Set	\$32⁹⁹ SET OF 3 ★

MAGNETIC DOUBLE 1ST BASE

- Perfect addition for those who have magnetic type bases
- "White part" is attached to the magnetic stanchion conventionally leaving the safety orange base in full contact with the ground.
- "Orange part" is at ground level.

1274127	\$234⁹⁹ EA ★
----------------	--------------------------------



GAME BASE CART

- Heavy-duty construction with 8" rubber tires
- Universal stems hold both 1" male and 1 1/2" female style bases
- Rubber grip handle

NJ State Approved Co-op #65MCECCPS - Metuchen/Garden State AppareBid Term: 5/9/18 - 5/8/20: Extended to 5/8/21

1378676	Base Transport Cart	\$254⁹⁹ EA ★
----------------	---------------------	--------------------------------

BASEBALL/SOFTBALL

MacGregor DOUBLE FIRST BASE



DOUBLE FIRST BASE

- One-piece molded rubber base
- No stitches to tear or rip
- Set includes 2 ground anchors for installation

BBDFBSNR 30"L x 15"W x 3"H **\$159⁹⁹** EA ★

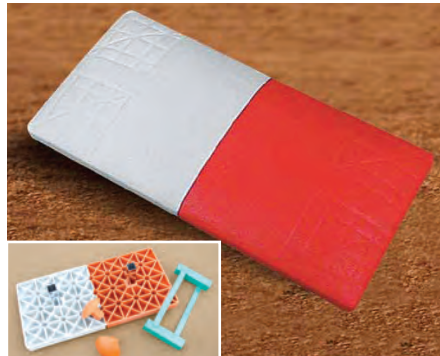

PREMIUM DOUBLE FIRST BASE

- One piece molded rubber base with simulated quilted top and steel stanchions
- Size - 30"L x 15"W x 3"H
- Weight: 33 lbs.

1235609 Set - Base, Anchor & Plugs **\$249⁹⁹** EA ★
1235616 Repl. Anchor Only **\$36⁹⁹** EA ★



RECREATIONAL DOUBLE FIRST BASE

- Designed to reduce the chances of collisions, spiking and injuries
- Heavy duty vinyl covering with soft rebounded foam filler
- Comes with 2 straps, 2 buckles and 2 spikes

BBDBLFB3 Size - 30"L x 15"W x 3"H **\$52⁹⁹** EA ★

MacGregor INDOOR/PE BASES



THROW DOWN BASES

- 5 piece orange rubber throw down home plate, pitcher's plate and three base set
- Ideal for both indoor and outdoor use
- Made of washable and flexible rubber

1235623 **\$16⁹⁹** SET ★



RUBBER BASES

- Solid white, heavy duty molded
- Rubber throwdown bases with suction grip underside
- For use indoor and out

BBSBXXXY Set of 3 **\$37⁹⁹** SET OF 3 ★
BBSBEEAY Single Base **\$15⁹⁹** EA ★



RUBBER HOME PLATE

- Official size with suction grip underside for use indoor and out.
- Heavy duty white molded rubber
- No spikes

BBSBHPXXY Home plate only **\$19⁹⁹** EA ★
BBSBHPEX Home Plate Extension (17" x 13") **\$27⁹⁹** EA ★

MacGregor BASE ACCESSORIES



BIG LEAGUE BASE PLUGS (3-PACK)

BBBLPLUGPK **\$39⁹⁹** PACK



HEAVY-DUTY BASEBALL/SOFTBALL BASE GROUND ANCHOR

BBMNBACH **\$39⁹⁹** EA ★



BASE ANCHOR FOUNDATION

- A quick and easy way to set your base ground anchors without using concrete
- Just bury and tamp in place, you are ready to insert base and play
- Set includes rubber platform with built-in polycarbonate anchor

1269895 Set of 3 **\$137⁹⁹** SET
1269901 Single **\$49⁹⁹** EA



UNIVERSAL RUBBER ANCHOR PLUG

BBRPLUGS **\$6⁹⁹** EA ★



STANDARD GROUND ANCHORS

BBANCHOR **\$32⁹⁹** SET OF 3 ★



ANCHOR CLEAN OUT TOOL

BBDIGOUT **\$15⁹⁹** EA ★

Bid #ESCNJ 17/18-31

Educational Services Commission of New Jersey

Athletic Equipment & Supplies

schutt HOLLYWOOD IMPACT KWIK RELEASE BASE



HOLLYWOOD IMPACT QUICK RELEASE BASES

- Patented Kwik-Release design compresses & disengages the base from its orange platform upon impact
- Fully compliant with Little League Rule 1.06
- Base platform stanchion fits standard ground anchor
- Female ground anchors and plugs are sold separately
- Bases are 15" x 15" x 3" and come in two resistance levels - youth or varsity.
- Youth bases take 20 lbs of force for base to "release"
- Varsity bases take 32 lbs of force for base to "release"

DOUBLE FIRST BASE DESIGN

- Kwik-Release™ double first base disengages completely when enough force hits the base, but the orange base remains anchored to the ground
- Size - 15" x 15" x 2 1/4 - 2 3/4"
- Ground plugs and anchors sold separately

1264791	Kwik-Release: Dbl. 1st + 2 Youth Bases	\$559 ⁹⁹ SET
1264807	Kwik-Release: Dbl. 1st + 2 Varsity Bases	\$559 ⁹⁹ SET

1274169	Varsity Set of 3 Bases - Weight: 60 lbs	\$399 ⁹⁹ SET
1274176	Varsity Individual Base - Weight: 20 lbs	\$159 ⁹⁹ EA
1274145	Youth Set of 3 Bases - Weight: 60 lbs	\$399 ⁹⁹ SET
1274152	Youth Individual Base - Weight: 20 lbs	\$159 ⁹⁹ EA
1236507	Ground Anchors - 3/Set	\$49 ⁹⁹ SET



SOFT TOUCH BASES



SOFT TOUCH™ DOUBLE FIRST BASE

- White side anchored in ground mount, orange side anchored under the base with spikes.

1236293	\$319 ⁹⁹ EA
---------	------------------------

Softtouch™ double first bases are not a release style base due to double ground anchors.



SOFTOUCH™ PROGRESSIVE RELEASE BASE

- Designed to flex and absorb energy as a player slides into the base
- "Pops out" on the impact of short, hard slides
- Molded 7" stem fits over the orange play-plug and inside the ground mount

1. BBBASBRE	Complete 15" Single Base	\$154 ⁹⁹ EA
2. BBBREMNT3	Extra Ground Mounts - Set of 3	\$54 ⁹⁹ SET
3. 20026504	Extra Tapered Plugs - Set of 3	\$82 ⁹⁹ SET
BBBASAYP	Plugs (fills ground mounts) - set of 3	\$89 ⁹⁹ SET



SOFT TOUCH CONVERTIBLE BASES

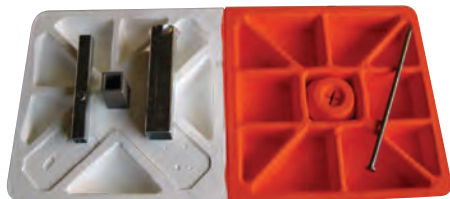

SOFT TOUCH™ CONVERTIBLE DOUBLE 1ST BASE

- Non-release style base
- Anchors into two ground anchors (not included)
- Male or female style

1274138	\$332 ⁹⁹ EA
---------	------------------------

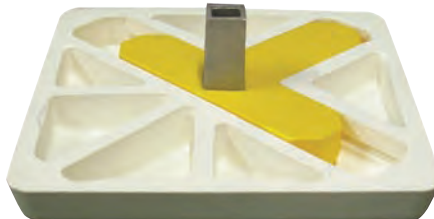

SOFTOUCH™ CONVERTIBLE BASES

- Designed to fit into your existing 1" male or 1-1/2" female ground anchors (ground anchors not included)
- Progressive release bases are designed to flex and absorb energy
- In the case of a short slide, the base is designed to pop free

1236309	Set of 3 - 15" Bases with Mounting Tees	\$444 ⁹⁹ SET
---------	---	-------------------------



SYNTHETIC TURF BASE

- Official size 15" x 15"
- Durable cut resistance polyurethane
- Bottom has a unique claw design that grabs the turf
- Does not require a mounting system

1375580	Set of 3 Single Base	\$559 ⁹⁹ EA
1375581	Set of 3 Single Base	\$217 ⁹⁹ EA

ADAMS BOLCO BASES

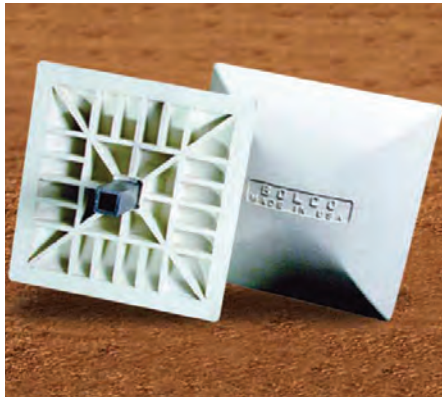

BOLCO 150-SB SAFETY BASE

- One piece all rubber construction with universal aluminum stanchion.
- Tapered sides reduce the risk of injury
- Fits male or female ground anchors
- Ground anchors not included

1196528 \$299.99 EA



ADAMS BOLCO 175-MLB MAJOR LEAGUE BASES (3-PACK)

- One piece all rubber construction with universal aluminum stanchion
- Will fit male or female ground anchor
- Ground anchors not included

1236408 Size -15" x 15" x 3" \$299.99 SET

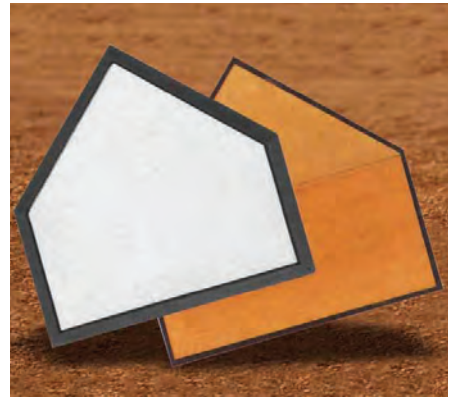

BOLCO 300-AS WOOD HOME PLATE

- Quality vinyl cover over wood block filler
- Regulation size - 3" thick
- Weight: 29 lbs.

1236415 \$124.99 EA



BOLCO 100-ML MAJOR LEAGUE BASES

- Bolt-on top plate design
- Official size 15" x 15" x 3"

1236316 Set of 3 Bases only \$189.99 SET
1236325 3 Bases, Top Plates & Anchors \$199.99 SET

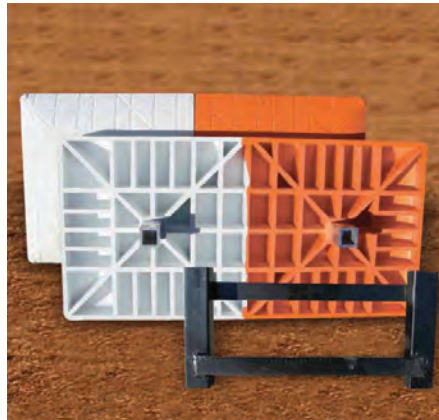

BOLCO DOUBLE FIRST BASE

- One piece molded double base
- Will fit male or female ground anchor (not included)

1196511 Size - 15" x 30" x 3" \$284.99 EA
1196535 Double Ground Anchor \$82.99 EA

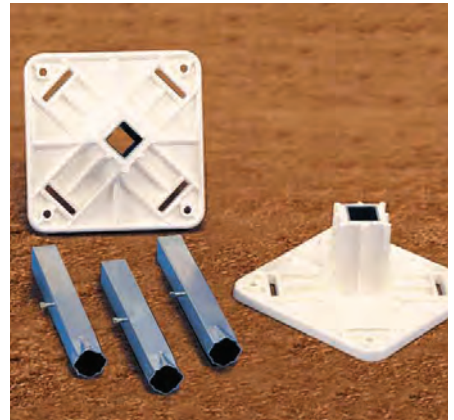

BOLCO 205-BA BASE ANCHOR SET

- Set contains 3 female plastic top plates and 3 male steel ground anchors to anchor 100-ML and 120-PRO bases.

1236330 Universal anchors \$89.99 EA



BOLCO 4-WAY PITCHER'S RUBBER

- Made of solid white rubber with PVC inner core
- Designed to be rotated to extend life

1236361 Official Size - 6" x 24" \$124.99 EA
1236378 Youth Size - 4" x 18" \$94.99 EA



BOLCO STEP DOWN PITCHER'S RUBBER

- Step down pitcher's plate with traditional solid wood core and molded rubber cover
- Front extension prevents holes in front of plate and reduces mound maintenance
- No stakes or spikes required

1236385 Official Size - 6" x 24" \$92.99 EA
1236392 Youth Size - 4" x 18" \$82.99 EA

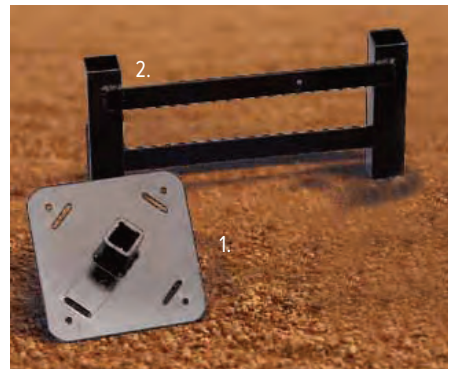

1. ANCHOR TOP PLATE

- One female plastic top plate that fits over male anchor stakes

1236347 Bolco Anchor Top Plate \$16.99 EA

2. DOUBLE GROUND ANCHOR

- All steel - for double 1st base or pitcher's rubber

1196535 Double Ground Anchor \$82.99 EA



HOLLYWOOD® SAF-T-SLIDER™ BASES

- Unique beveled corners sit flush with the ground
- Durable, heavy-gauge rubber construction
- Ideal for youth and recreational softball play
- Ground anchors sold separately

1036992 \$324.99 SET



HOLLYWOOD IMPACT BASES

- Constructed of high quality rubber with honeycomb design for flexibility and durability
- Base compresses as runner slides into it
- Replaceable steel stanchion fits the hollywood ground anchor (sold separately)

1236439 Size - 15" x 15" x 2" \$344.99 SET



ORIGINAL HOLLYWOOD BASES®

THE ORIGINAL JACK CORBETT® BASES USED BY MAJOR LEAGUE BASEBALL SINCE 1939

- Major league base designed to provide greater strength and durability under constant usage.
- Tapered lip ground hugging feature reduces possibility of edge turn-up due to impact.
- Natural rubber cover with steel stanchion.
- Requires Hollywood ground anchors.
- Anchors and base plugs sold separately

1036930 Size - 15" x 15" x 3" \$274.99 SET



HOLLYWOOD 4-WAY PITCHER'S RUBBER

- The most stable, rugged, 4-sided pitching rubber available
- Interior aluminum tube for maximum longevity when filled with dirt or concrete

1236460 Official Size - 6" x 24" \$192.99 EA



HOLLYWOOD IMPACT DOUBLE FIRST BASE

- Constructed of high quality rubber with honeycomb design
- Base compresses as runner slides into it.
- Anchors and base plugs sold separately

1236453 Base only \$234.99 EA

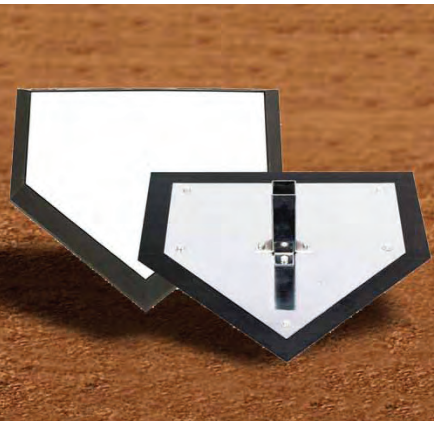

HOLLYWOOD HOME PLATE

- Stanchion mounted professional homeplate

1236484 \$162.99 EA

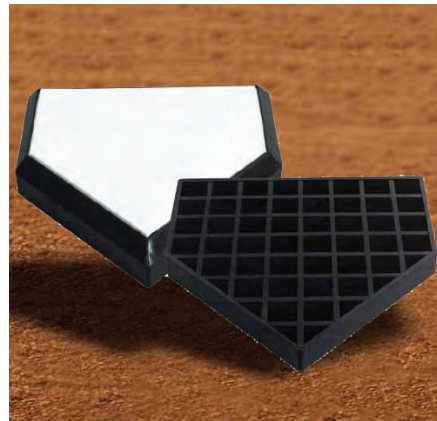

HOLLYWOOD BURY-ALL HOME PLATE

- High-durability, all rubber waffle design
- No corners or edges to catch spikes

1236477 \$172.99 EA



ACCESSORIES

- 1. **1236507** Ground Anchors - 3/Set \$49.99 SET
- 2. **BBRPLUGS** Base Plugs \$6.99 EA *
- 3. **1236491** (with friction) \$57.99 EA
- 4. **BBDIGOUT** Dig-Out Tool \$15.99 EA *

MOUNDS



PITCHER'S PLATFORM

- Protects field during batting practice
- Rugged aluminum frame
- Attached tires for easy portability
- Non-marking pads included for indoor use
- Mound height adjusts from 10" to 6"
- No flat tires

BSPROPLAT 7'L x 3'W x 10'6" H \$999⁹⁹ EA **S&H**



TWO PIECE PRACTICE MOUND

- 2-piece mound w/turf made with high density foam and protected with Rubber Armor Technology
- Skid proof, non-slip bottom - won't damage gym floors
- Used by NCAA Division 1 programs

MP2031 Size - 10"H x 4'W x 9'L \$1,299⁹⁹ EA **S&H**

Includes free measuring tape!

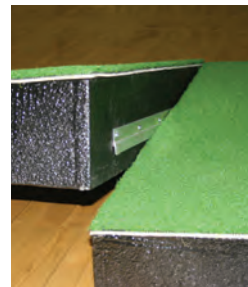

Includes free measuring tape!



PRACTICE MOUND WITH TURF

- Heavy duty polystyrene that is completely encased in a thick rubber coating for durability
- Rubber coating is skid resistant and will not damage gym floors
- Spike proof turf top will accommodate all cleats including metal

1237146 Size - 10"H x 5'W x 9'L \$1,399⁹⁹ EA **S&H**

1237153 Size - 10"H x 4'W x 9'L \$1,299⁹⁹ EA **S&H**



BP MOUND

- Durable fiberglass construction
- 60oz Astroturf covering
- 6 year warranty on fiberglass shell
- Won't slip on gym floors

1396131 6'2"W x 9'4"L x 10"H \$2,499⁹⁹ EA **S&H**



TRAINING MOUND

- Made of high density foam and protected with Rubber Armor Technology
- Used at all levels of play for indoor drills
- Great for backyard training, camp and clinics
- Portable, lightweight, durable
- Please specify: green or red clay turf

MP3001 Size - 4"H x 36"W x 36"L \$399⁹⁹ EA

SOFTBALL PITCHERS MATS



PROMOUNDS JENNIE FINCH PITCHING MAT WITH POWERLINE

- Pitching mats made from spike-resistant/turf
- 2" wide inlaid white line for more precise training
- Regulation pitching rubber attached
- Comes with a convenient carrying case
- Non-skid bottom for gym floors

1266016



JENNIE FINCH PITCHER'S LANE PRO

- Regulation pitching rubber attached and made from spike-resistant artificial turf with a no slip backing.
- Helps pitchers comply with NCAA regulations (Rule 2.19) that restricts pitchers from pitching outside the 24' pitching rubber.
- Comes with a free carrying case.

1291360 Size - 3'W x 40'L \$299⁹⁹ EA



MOUNDS



LIGHTWEIGHT | DURABLE | PORTABLE

ProMounds Portable Pitching Mounds

ProMounds Game Mounds are the perfect combination of durability and portability in a lightweight mound. ProMounds mounds are constructed of a solid, high-density foam core coated with P.R.A.T. (ProMounds Rubber Armor Technology) and are covered with a durable, high-quality artificial turf. Convert any field to a baseball field easily!

- + Lightweight-Durable-Portable
- + Covered in high-quality (spike-resistant) artificial turf
- + Solid core. No bounce creates an authentic mound feel
- + Can be used indoors and outdoors
- + Designed to have field surface built up around the edges of the mound
- + 40% lighter than fiberglass construction

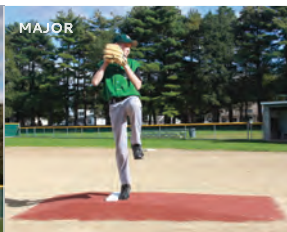

MAJOR

PROMOUNDS MAJOR LEAGUE GAME MOUND

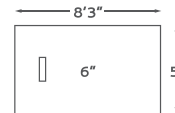

- 6" Height
- Pitch from the rubber and land on the mound
- Plenty of room for pick-off moves
- Can be used indoors and outdoors
- Available in Clay or Green

MP3003 6"H x 60"W x 99"L \$1,299⁹⁹ EA



MINOR

PROMOUNDS MINOR LEAGUE GAME MOUND

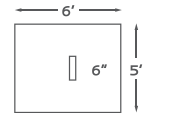

- 6" Height
- Pitch from the rubber and land on the dirt
- Plenty of room for pick-off moves
- Can be used indoors and outdoors
- Available in Clay or Green

MP3002 6"H x 60"W x 72"L \$979⁹⁹ EA



5070

PROMOUNDS 5070 GAME MOUND

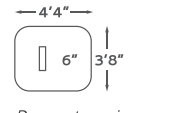

Does not require freight shipping!

- 6" Height
- Designed for both field conversion and backyard training
- Throw from the rubber and land on the dirt
- Can be used indoors and outdoors
- Available in Clay or Green

1450722 6"H x 3'8"W x 4'4"L \$499⁹⁹ EA



TRAINING

PROMOUNDS TRAINING MOUND

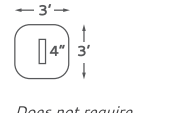

Does not require freight shipping!

- 4" Height
- Designed for both field conversion and backyard training
- Throw from the rubber and land on the dirt
- Excellent for practicing pick-off moves indoors
- Can be used indoors and outdoors
- Available in Clay or Green

MP3001 Size - 4"H x 36"W x 36"L \$399⁹⁹ EA

PORTABLE MOUNDS FOR EVERY GAME

6 YEAR WARRANTY*
*FIBERGLASS SHELL



PORTABLE GAME MOUND

- Reinforced fiberglass and covered with AstroTurf®
- Lifetime fiberglass base cover

BBPORTRE Senior - 10"H x 10"W x 12"6"L \$4,999⁹⁹ EA

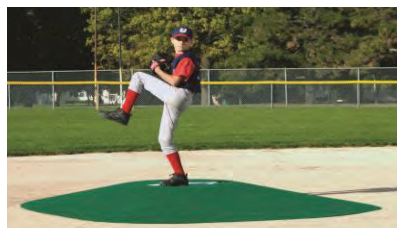

PORTABLE GAME MOUND

- Approved for Official Bronco League games
- Meets Pony League and Dixie Youth baseball specifications

1450721 6"H x 8'1"W x 10'1"L \$2,959⁹⁹ EA



PORTABLE PITCHER'S MOUND

- Approved for official Bronco League games.
- Made of reinforced fiberglass and covered with AstroTurf.

BBPORTPB Pony League - 8"H x 9"W x 11"L \$3,999⁹⁹ EA



PORTABLE GAME MOUND

- Reinforced fiberglass and covered with AstroTurf®
- Lifetime fiberglass base cover

1450720 10"H x 10"W x 12"6"L \$4,999⁹⁹ EA



BATTING PRACTICE PLATFORM

- Fiberglass construction
- 6-Year factory warranty.

1295128 4"H x 7'1" x 10'4" \$1,799⁹⁹ EA



FOUR PIECE GAME MOUND

- Meets all NCAA requirements
- Full regulation 18' fiberglass pitching mound

1396130 18" Regulation \$11,999⁹⁹ EA

NJ State Approved Co-op #65MCESCCPS Metuchen/Garden State Apparel Bid Term: 5/9/18 - 5/8/20: Extended to 5/8/21

APPROVED FOR TOURNAMENT & GAME USE BY



BASEBALL/SOFTBALL



STALKER SPORT 2 RADAR GUN

- Simultaneously displays release and plate speeds
- Displays speed in either units or tenths
- Concurrent radar and stopwatch operation
- Uses AA NiMh rechargeable batteries
- Rugged polymer case
- In-gun-battery wall charger is included

1274813 Complete Unit \$969⁹⁹ EA



VELOCITYTM SPEED GUN

- Ideal for youth through high school programs.
- Using digital signal processing, it measures the velocity of a baseball or softball up to 110 mph from a distance of 100 feet away
- Heavy-duty construction, large LCD readout, and easy-to-use instructions
- Uses 2 "C" batteries (not included)

1087932 \$199⁹⁹ EA



CORDLESS RADAR GUN

- Operates on two rechargeable Black & Decker batteries
- Advanced DSP technology allows faster and more accurate readings release point
- Operates in manual trigger mode and automatic mode

2 Year Limited Warranty

1235982 \$1,499⁹⁹ EA



ROSIN BAG

- High quality rosin in resealable polybag for long-lasting use.

5A162628 \$6⁹⁹ EA



Robic

DUAL PITCH COUNTER

- Keeps count of 2 pitchers
- Counts balls, strikes, and total pitches
- Counts up or down

1399575 \$19⁹⁹ EA



HOME & ROAD PITCH COUNTER

- Dual pitch counter allows coaches to track two pitchers at once
- Sleek design fits ergonomically in hand

1264067 Black only \$17⁹⁹ EA



TALLY COUNTER

- Hand held model
- Counts up to 9999

MSHTALLY \$9⁹⁹ EA ★

SKYSCANTM P5 LIGHTNING DETECTOR

- Detects lightning as far as 40 miles away and accurately ranges its approach by both an audible tone and by four LED's which are ranged in miles (0-3, 3-8, 8-20, 20-40)
- Requires (2) 9V batteries (not included)
- AC adapter not included
- Rugged weather resistant case

SKYSCANX Portable Unit \$299⁹⁹ EA
 20026501 Soft Carry Case \$39⁹⁹ EA
 20026502 110v AC Adapter \$39⁹⁹ EA





SINGLE WHEEL BB/SB PITCHING MACHINE

- Speed: 30-60 mph
- Throws baseballs, 11" and 12" softballs
- Runs on 110 volt AC or generator 1/4 HP D.C. motor
- Durable urethane wheel eliminates air pressure issues
- Heavy duty legs are convertible for baseball or softball

BBD0G1XX	Complete Unit	\$774 ⁹⁹ EA ★
BBD0G1WL	Replacement Wheel	\$234 ⁹⁹ EA ★

ELITE 2 WHEEL PITCHING MACHINE

- Throws curves, fastballs, sliders, sinkers and knuckleball
- Can throw pop-ups as well as grounders
- Pitch speed between 30 - 102 mph
- Urethane wheels eliminate air pressure problems
- Attached wheels for easy transport
- Best suited to throw dimple balls
- Weight: 95 lbs.

BULLELITEBB	Baseball Model	\$1,799 ⁹⁹ EA ★
BULLELITESB	Softball Version	\$1,799 ⁹⁹ EA ★
ZPMLEGSB	BB to SB conversion kit - Includes legs & chute	\$149 ⁹⁹ SET ★
ZPMLEGBB	SB to BB conversion kit - Includes legs & chute	\$149 ⁹⁹ SET ★



Holds 500 Baseballs!

DELUXE IRON MIKE (MP5)

- Ball rack capacity: 38 baseballs or 28 softballs
- Easily converted from baseball to softball
- Four wheel transport for quick, easy moving
- Low voltage remote control with 80' cord
- Electrically powered by 115 volt AC motor
- Lockable arm guard cover
- Speed up to 85 mph
- Please choose either a softball or baseball pitching arm

1237214	Complete Unit	\$3,499 ⁹⁹ EA	
1273946	Weather Cover (MP-5)	\$199 ⁹⁹ EA	

DELUXE IRON MIKE W/HOPPER (MP6)

- Heavy duty hand and arm system simulates wind-up and delivery
- Speed from 25 - 85 mph
- Operates on 110V power with 80' low voltage remote switch
- Includes a hopper for 600 baseballs
- Transport wheels not included
- Weight: 600 lbs

1273939	Complete Unit	\$4,099 ⁹⁹ EA	
1273984	Weather Cover (MP-4 & MP-6)	\$269 ⁹⁹ EA	



DIMPLED MACHINE BALLS

- Soft, durable yellow polyurethane
- Designed safe for aluminum bats

MCDBBYEL	9" Baseball	\$32 ⁹⁹ DZN ★
BBDSBALL	12" Softball	\$38 ⁹⁹ DZN ★



ULTIMATE® PITCHING MACHINE

- Versatile non-electric pitching machine
- Throws baseballs, softballs and safety balls
- Speeds up to 45 MPH
- Quickly and easily adjust the pitch speed and location
- Little League® approved
- Weight: 15 lbs



200160111	Complete Unit	\$299 ⁹⁹ EA
1658888	Replacement Spring	\$12 ⁹⁹ EA

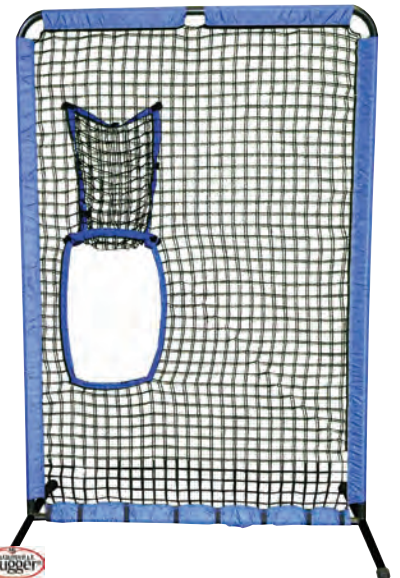

PORTABLE PITCHING SCREEN

- For use with Ultimate Pitching Machine

560115	Size - 48" W x 72" H x 36" D	\$137 ⁹⁹ EA
---------------	------------------------------	------------------------

FLAT SEAM



OFFICIAL LEAGUE

- Leather cover
- Cork and rubber core
- Yarn windings
- Flat seams

BSOLBFS

Flat Seam

\$34.99 DZN ★



SPALDING

NJCAA

- Premium full grain leather cover
- Gray and white wool winding
- Cushion cork center

1389839

Flat Seam

\$79.99 DZN



SPALDING

NJCAA - PRACTICE

- Official NJCAA flat seam practice baseball
- Premium full grain leather cover
- Gray and white wool winding
- Cushion cork center

1389840

Flat Seam

\$59.99 DZN



Wilson

A1010 PRO

- Grade A full grain leather
- Cushioned cork
- Premium gray wool windings
- Flat seam

1385405

Flat Seam

\$93.99 DZN



Wilson

A1030

- Grade C/D full grain leather
- Red cushioned cork
- Gray wool windings
- Flat seam

1385406

Flat Seam

\$52.99 DZN



Diamond

D1 PRO

- Full grain leather cover
- Cushioned cork center
- Grey wool windings
- Flat seam

1385517

Flat Seam

\$92.99 DZN

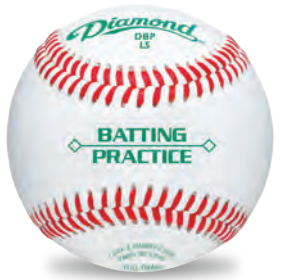

Diamond

DBP - PRACTICE

- Full grain leather cover
- Cork and rubber core
- Yarn windings
- Flat seam

1385518

Flat Seam

\$59.99 DZN



Rawlings

FSR1 NCAA

- Official ball of the NCAA
- Full grain leather cover
- Cushioned cork center
- Wool windings
- Flat seam

1385512

Flat Seam

\$99.99 DZN



Rawlings

FSR100 NAIA

- Official ball of the NAIA
- Full grain leather cover
- Cushioned cork center
- Wool windings
- Flat seam

1385513

Flat Seam

\$99.99 DZN



Rawlings

FSR100

- Full grain leather cover
- Cushioned cork center
- Flat seams

1385514

Flat Seam

\$99.99 DZN



Rawlings

FSOLBX - PRACTICE

- Practice Ball
- Leather cover
- Flat seams

1385515

Flat Seam

\$64.99 DZN

Bid #ESCNJ 17/18-31

Educational Services Commission of New Jersey

Athletic Equipment & Supplies

HIGH SCHOOL / COLLEGE

BASEBALL/SOFTBALL



MacGregor
#79 PRACTICE

- Cork and rubber core
- Raised seams

MCB79PXX Leather \$37.99 DZN ★
MCB79PYX Synthetic \$22.99 DZN ★



MacGregor **NFHS**
#97 MAJOR LEAGUE

- Cushioned cork center
- Gray/white/gray yarn windings
- A grade leather cover
- Raised seams

MCB97MLH w/NFHS Logo \$57.99 DZN ★
MCB97MLX w/o NFHS Logo \$55.99 DZN ★



MacGregor
#97 PROFESSIONAL LEAGUE

- Cushioned cork center
- Grey english wool windings
- A grade leather cover
- Raised seams

MCB97PRO \$55.99 DZN ★

MARK1
OFFICIAL LEAGUE

- Leather cover
- Cork and rubber core
- Yarn windings
- Raised seams

BSOLB \$33.99 DZN ★



MacGregor
#87SP OFFICIAL LEAGUE

- Cork and rubber center
- Split leather cover
- Raised seams

MCB87SPX \$33.99 DZN ★



MacGregor
#87OL OFFICIAL LEAGUE

- Cushioned cork center
- Select wool windings
- Leather cover
- Raised seams

MCB87OLX \$44.99 DZN ★



Wilson
A1030B HIGH SCHOOL

- Cushioned cork center
- Grey wool windings
- Grade C leather cover
- Raised seams

5A1030B \$54.99 DZN



Baden **NFHS**
3B-NFHS

- NFHS approved baseball
- Premium Leather cover
- Performance seams
- Ballistic windings

1362015 \$74.99 DZN



Wilson **NFHS**
A1010 PRO - NFHS

- Grade A full grain leather
- Premium gray wool windings
- Raised seams
- Red cushioned cork center

CCA1010BPRO \$102.99 DZN



Diamond
DBP PRACTICE

- Cork and rubber pill
- A-Grade gray wool winding
- Premium leather cover
- Diamond Seam™

1159042 \$58.99 DZN



Diamond **NFHS**
D1-PRO

- Cushioned cork center
- A-1 grade wool winding
- Premium leather cover
- Diamond Seam™

1187359 \$94.99 DZN



Diamond **NFHS**
DOL1

- Cork & rubber core
- Select wool blend windings
- Full grain leather cover
- Diamond seams

BSDOL1 \$54.99 DZN



Wilson **NFHS**
A1010 H.S. SST

- NFHS approved
- Red cushion cork center
- Premium wool windings
- Grade A leather cover

1371531 \$83.99 DZN



SPALDING **NFHS**
PRO SERIES

- Premium full grain leather cover
- Gray & white wool windings
- Raised seams
- Cushioned cork center

1394786 \$84.99 DZN



Diamond **NFHS**
D1-PRO NFHS

- Cushioned cork center
- A-1 Grade wool winding
- Premium leather cover

1187366 \$94.99 DZN



Diamond **NFHS**
DOL-A OFFICIAL LEAGUE

- Cushioned cork center
- A-grade grey wool winding
- Premium leather cover

1159028 \$69.99 DZN



Diamond **NFHS**
D1-NFHS

- Cushioned cork center
- A-grade grey wool winding
- Premium leather cover

1187373 \$84.99 DZN

No State Approved Co-op #65MCECOPS Metuchen/Garden State Apparel Bid Term: 5/9/18 - 5/8/20: Extended to 5/8/21

Bid #ESCNJ 17/18-31

Educational Services Commission of New Jersey

Athletic Equipment & Supplies



PONY



MacGregor #75 OFFICIAL PONY®

- Cushioned cork center
- Select wool windings
- Leather cover
- Raised seams

MCB75CXX \$45.99 DZN ★



MacGregor #75CY YOUTH PONY®

- Cork and rubber center
- Select wool windings
- Leather cover
- Raised seams

MCB75CYX \$39.99 DZN ★



Diamond DPL PONY LEAGUE

- Cushioned cork center
- A-Grade gray wool winding
- Premium leather cover
- Tournament grade

1159059 \$74.99 DZN



Rawlings RPLB1 PONY LEAGUE

- Cork and rubber center
- Full grain leather cover
- Raised seams

1420274 \$52.99 DZN



DIZZY



Rawlings RDZY1 DIZZY DEAN

- Cork and rubber center
- Full grain leather cover
- Raised seams

1419932 \$52.99 DZN



DIXIE



MacGregor #78 DIXIE® BOYS & MAJORS

- Cushioned cork center
- Select wool windings
- Leather cover
- Raised seams

MCB78CXX \$43.99 DZN ★



MacGregor #72 DIXIE® YOUTH

- Cork and rubber center
- Select wool windings
- Leather cover
- Raised seams

MCB72CXX \$39.99 DZN ★



Diamond DDY-1 DIXIE YOUTH

- Cork and rubber pill
- Select wool blend winding
- Premium leather cover
- Diamond Seam™

1159141 \$57.99 DZN



CAL RIPKEN



MacGregor #74 CAL RIPKEN®

- Cork and rubber center
- Select wool windings
- Leather cover
- Raised seams

MCB74CAL \$39.99 DZN ★



Rawlings RCAL1 CAL RIPKEN®

- Cork and rubber center
- Full grain leather cover
- Raised seams

1055795 \$52.99 DZN



BABE RUTH



MacGregor #74 OFFICIAL BABE RUTH®

- Cushioned cork center
- Select wool windings
- Leather cover
- Raised seams

MCB74CXX \$44.99 DZN ★



Diamond DBR-1 BABE RUTH

- Cork and rubber pill
- Select wool blend winding
- Premium leather cover
- Competition grade baseball

1159080 \$59.99 DZN



Rawlings RBRO(1) BABE RUTH®

- Cushioned cork center
- Leather cover
- Raised seams

1055774 \$72.99 DZN
1055788 \$52.99 DZN



USSA



Rawlings ROLB1 - USSA

- Cork and rubber center
- Full grain leather cover
- Raised seams
- USSA approved

1055801 \$52.99 DZN
1055818 \$47.99 DZN



Wilson A1030 USSA

- Cushioned cork center
- Gray wool yarn
- Grade C leather cover
- Raised seam

1195279 \$59.99 DZN

Bid #ESCNJ 17/18-31

Educational Services Commission of New Jersey

Athletic Equipment & Supplies



Little League

© 2016 Little League Baseball, Incorporated, All Rights Reserved.

BASEBALL/SOFTBALL



**SPALDING
OFFICIAL**

- Cushioned cork center
- Gray wool windings
- Full grain leather cover
- Raised seams

1323757 \$59⁹⁹ DZN



**Rawlings
RLLB**

- Full grain leather cover
- Raised seams
- RS-T stamped

1055740 Cushioned Cork \$72⁹⁹ DZN
1055757 Cork & Rubber \$49⁹⁹ DZN



**MacGregor
#76C1**

- Cork and rubber center
- Select wool windings
- Raised seams

MCB76C1X Leather Cover \$42⁹⁹ DZN ★



**MacGregor
#76C**

- Cushioned cork center
- Raised wool windings
- C Grade Leather cover
- Raised seams / RS-T stamped

MCB76CXX C Grade Cover \$43⁹⁹ DZN ★



**Diamond
DLL-1**

- Little League competition grade baseball
- Premium leather cover
- Raised seams

1159103 Cork & Rubber \$56⁹⁹ DZN
1159097 DLL Cushioned Cork \$73⁹⁹ DZN



**Wilson
A1074BSST**

- Red cushion cork center
- Grey wool windings
- Raised seams

5A1074BSST B Grade Cover \$72⁹⁹ DZN
5A1074BLL1 C Grade Cover \$59⁹⁹ DZN



Sr. Little League

© 2016 Little League Baseball, Incorporated, All Rights Reserved.



**Diamond
DSLL-1 SENIOR LEAGUE**

- Cork and rubber pill center
- Select wool blend winding
- Premium leather cover
- Diamond Seam

1159127 \$58⁹⁹ DZN



**Rawlings
RSLL SENIOR LEAGUE**

- Cushioned cork center
- Full grain leather cover
- Raised seams
- RS-T stamped

1055764 \$72⁹⁹ DZN



**Wilson
A1072BSST SR. LITTLE LEAGUE®**

- Features Super Seam Technology™
- Cushioned cork center
- RS-T Stamped

1015683 \$73⁹⁹ DZN



**MacGregor
#73C SENIOR LEAGUE**

- Cushioned cork center
- Select wool windings
- Leather cover
- Raised seams

MCB73CXX \$47⁹⁹ DZN ★

TEE BALL



**MacGregor
#56 OFFICIAL TEE BALL**

- "Vyntan" synthetic leather cover
- Low bounce rubber core
- Double-stitched seams
- Ideal for tee ball & indoor or outdoor training

MCB56TBX \$32⁹⁹ DZN ★

SAFETY



**MacGregor
SAFE/SOFT BASEBALL**

- 3 LEVELS OF SAFETY FOR ALL AGES
- Meets NOCSAE standard
 - Leather cover with patented Tri-Flex safety core
 - Raised seams

MCB55V01 Level 1 Ages 5-7 \$48⁹⁹ DZN ★
MCB55V03 Level 3 Ages 8-10 \$48⁹⁹ DZN ★
MCB55V10 Level 10 Ages 12+ \$48⁹⁹ DZN ★



**Rawlings
RIF TRAINING BASEBALLS**

- Leather cover
- Sponge rubber center
- Softer and lighter than traditional baseballs
- Little League approved

RWRIF5L Ages 5-7 \$72⁹⁹ DZN

NJ State Approved Co-op #65MCECOPSVO1 Metuchen/Garden State Apparatus Bid Term: 5/9/18 - 5/8/20: Extended to 5/8/21

MacGregor FAST PITCH SOFTBALLS



BEST SELLER

LITTLE LEAGUE® APPROVED

- League approved / stamped
- COR .47/375 lb max comp.
- Poly graphite center
- Leather cover

MCSB11LLY	11"	\$59 ⁹⁹ DZN ★
MCSB12LLY	12"	\$64 ⁹⁹ DZN ★

NFHS APPROVED

- 12" NFHS approved
- COR .47/375 max comp.
- Leather cover
- Raised stitch
- Poly-core

BSOSB	12"	\$54 ⁹⁹ DZN ★
--------------	-----	--------------------------



PRACTICE

- Slowpitch or fastpitch
- COR, compression, cover, center may vary

5PSBY11	11"	\$47 ⁹⁹ DZN ★
5PSBY12	12"	\$47 ⁹⁹ DZN ★



SAFE/SOFT TRAINING

- Perfect for drills
- Leather cover
- Tri-Flex safety core

MCSB11SS	11"	\$58 ⁹⁹ DZN ★
MCSB12SS	12"	\$59 ⁹⁹ DZN ★

© 2016 Little League Baseball, Incorporated, All Rights Reserved.



NFHS FAST PITCH

- NFHS approved
- COR .47/375 lb max comp.
- Poly graphite center
- Leather cover
- Red stitch

MCSB12YH	12"	\$65 ⁹⁹ DZN ★
-----------------	-----	--------------------------



ASA® FAST PITCH

- ASA® approved
- Cor. .47 / 375 lb max comp
- Poly graphite center
- Leather cover
- Red stitch

MCSB11YL	11"	\$59 ⁹⁹ DZN ★
MCSB12YL	12"	\$65 ⁹⁹ DZN ★



CORK CENTER ASA FAST PITCH

- ASA® approved
- COR .47/ 375 lb max comp.
- Cork center
- Leather cover
- White stitch

1280548	12"	\$47 ⁹⁹ DZN ★
----------------	-----	--------------------------



PONY® FAST PITCH

- Pony approved
- COR .47/375 lb max comp.
- Poly graphite center
- Leather cover

MCSB11PNY	11"	\$59 ⁹⁹ DZN ★
MCSB12PNY	12"	\$64 ⁹⁹ DZN ★

MacGregor SLOW PITCH SOFTBALLS



X52RE ASA SLOW PITCH

- ASA approved
- COR 52/300 max. comp
- Poly graphite core
- Red stitching

1377375	12" - Synthetic Cover	\$48 ⁹⁹ DZN ★
1377376	12" - Composite Core	\$53 ⁹⁹ DZN ★
1377377	12" - Leather Cover	\$63 ⁹⁹ DZN ★



X44RE ASA SLOW PITCH

- ASA® approved
- COR .44 / 375 lb max comp.
- Yellow leather cover
- Red stitching
- Compressed cork core

1280517	11"	\$49 ⁹⁹ DZN ★
----------------	-----	--------------------------



X44RP ASA® SLOW PITCH

- ASA® approved
- COR .44/375 max compression
- Yellow leather cover
- Red stitching
- X100 poly graphite core

1184761	11"	\$59 ⁹⁹ DZN ★
----------------	-----	--------------------------



POLY-CORE SLOW PITCH

- No ASA markings
- COR .47 / 375 max comp.
- Leather cover
- Poly graphite core
- Red stitching

1280531	12"	\$64 ⁹⁹ DZN ★
----------------	-----	--------------------------

Bid #ESCNJ 17/18-31

Educational Services Commission of New Jersey

Athletic Equipment & Supplies

DUDLEY SOFTBALLS



ASA THUNDER ZN HYCON

- ASA approved
- COR .52/300 lbs max comp
- Poly center
- Composite cover
- Red Stitch

1375626 12" \$78.99 DZN



THUNDER SY CLASSIC W SLOW PITCH

- USSSA approved
- COR .44/400 lbs max comp.
- Classic W stamped
- Synthetic cover / poly center

1300291 11" \$58.99 DZN



THUNDER SY USSSA SLOW PITCH

- USSSA approved
- COR .40/325 lbs max comp.
- Classic M stamped
- Synthetic cover / poly graphite center

1265996 12" \$62.99 DZN



ASA THUNDER HEAT HYCON

- ASA approved
- COR .52/300 lbs max comp
- Poly center
- Leather cover
- Red stitch

1375625 12" \$88.99 DZN



THUNDER ADVANCE MLT

- Non-association ball
- 12" COR .44/375 lbs max comp.
- Advance MLT series tech.
- Composite cover / poly center
- Blue stitch

1300284 12" \$76.99 DZN



OFFICIAL LITTLE LEAGUE FAST PITCH

- Official Little League softball
- Cor. .47/375 lb max comp
- Cork center
- Leather cover

1323764 11" \$77.99 DZN



THUNDER ZN USSSA SLOW PITCH

- USSSA approved
- COR .47/450 lb max comp.
- Composite cover / poly center
- Stadium stamped

1265989 12" \$87.99 DZN



ASA THUNDER SY HYCON

- ASA approved
- COR .52/300 lbs max comp
- Poly center
- Synthetic cover
- Red stitch

1375627 12" \$67.99 DZN



SB12LND NFHS FAST PITCH

- NFHS approved
- COR .47/375 lb max comp.
- Cork center
- Leather cover

BBDUDYEL 12" \$84.99 DZN



THUNDER HEAT NFHS FAST PITCH

- NFHS approved
- COR .47 / 375 lb max comp.
- Poly graphite center
- Leather cover

BBDNHFSY 12" \$89.99 DZN

WORTH SOFTBALLS



GREEN DOT SLOWPITCH

- ASA approved
- COR .52/ 300 comp
- Red stitch
- Pro Tac cover

1397384 11" \$66.99 DZN



SUPER GREEN DOT CLASSIC SLOWPITCH

- USSSA approved
- COR .44/ 400 lbs. max comp.
- Optic yellow Pro Tac cover
- Poly-core with C-Lok technology

1265781 11" \$78.99 DZN



BLUE DOT SLOW PITCH

- Not ASA approved
- COR .47 / 525 lb max comp.
- Pro Tac cover
- Poly graphite center
- C-LOK moisture barrier technology

1193930 12" \$78.99 DZN



SUPER GREEN DOT SLOWPITCH

- ASA Approved
- Cor. .44/375 lb max comp
- Red Stitch
- Pro Tac cover

1385212 11" \$69.99 DZN



HOT DOT SLOWPITCH

- ASA Approved
- Cor. .52/ 300 lb max comp
- Red stitch
- C-LOK technology

1385211 12" \$82.99 DZN



SUPER GOLD DOT CLASSIC SLOW PITCH

- USSSA approved
- COR .40/325 lbs. max comp.
- Pro Tac cover
- Poly-core with C-Lok technology

1265774 12" \$79.99 DZN



SOFTBALLS



RED DOT FAST PITCH

- ASA/NFHS Approved
- Cor. .47/375 lb max comp
- Yellow leather cover
- 88 red stitch
- Poly X core

RWPX2RYLAH 12" \$96.99 DZN



DREAM SEAM FAST PITCH

- ASA/NFHS approved
- .47 COR
- 375 compression
- High-density cork core
- Optic yellow cover
- 88 red stitch

RWC12RYLA 11" \$93.99 DZN



OFFICIAL NCAA CHAMPIONSHIP FAST PITCH

- Official NCAA championship ball
- COR .47/400 compression
- Polycore center
- Pro leather cover
- Raised seam, red stitch

RWNC12L 12" \$117.99 DZN

BASEBALL/SOFTBALL

Bid #ESC NJ 17/18-31

Educational Services Commission of New Jersey

Athletic Equipment & Supplies

EVIL SPORTS EVIL SOFTBALLS
(ALL EVIL SPORTS SOFTBALLS ARE LEATHER COVERED)



EVIL- ASA - RP

- 52 COR
- 300 Comp
- Red stitch

1394793 12" \$64⁹⁹ DZN

EVIL - ASA

- 44 COR
- 375 Comp
- Red stitch

1394791 11" \$64⁹⁹ DZN
1394792 12" \$64⁹⁹ DZN

EVIL - USSSA CLAS M

- .40 COR
- 325 Comp
- Blue stitch

1394795 12" \$64⁹⁹ DZN

EVIL - ISA

- .44 COR
- 375 Comp
- Green stitch

1394799 12" \$64⁹⁹ DZN



EVIL - NSA

- .52 COR
- 275 Comp
- Black stitch

1394798 12" \$64⁹⁹ DZN



ULTIMATE EVIL

- .53 COR
- 500 Comp
- Red/Orange stitch

1394800 12" \$64⁹⁹ DZN



EVIL - 44 MAX

- .44 COR
- 525 Comp
- Blue stitch

1394797 12" \$64⁹⁹ DZN

BATTING PRACTICE BALLS



EVIL - BATTING PRACTICE

- .44 COR
- 400 Comp
- Red stitches

1394802 12" \$46⁹⁹ DZN



EVIL - BATTING PRACTICE

- .52 COR
- 300 Comp
- Black stitch

1394803 12" \$46⁹⁹ DZN

THE ROCK

(ALL ROCK SOFTBALLS ARE COMPOSITE LEATHER COVERED)

ROCK - ASA - RP

- .52 COR
- 300 Comp
- Red Stitch

1394808 12" \$62⁹⁹ DZN



ROCK - ASA

- .44 COR
- 375 Comp
- Red Stitch

1394806 11" \$62⁹⁹ DZN



ROCK - ASA

- .44 COR
- 375 Comp
- Red stitch

1394807 12" \$62⁹⁹ DZN



ROCK - USSSA CLAS W

- .44 Cor
- 400 Comp
- Blue Stitch

1394809 11" \$62⁹⁹ DZN



ROCK - USSSA CLAS M

- .40 COR
- 325 Comp
- Blue Stitch

1394810 12" \$62⁹⁹ DZN



ROCK - NSA - RP

- .52 COR
- 275 Comp
- Black Stitch

1394812 12" \$62⁹⁹ DZN

TRUMP®

BASEBALL/SOFTBALL

AK-EZ SERIES SOFTBALLS



TRUMP - ASA

- .44 COR
- 375 Comp
- Synthetic cover
- Red Stitch

1394813 11" \$46⁹⁹ DZN

TRUMP - ASA

- .44 COR
- 375 Comp
- Leather cover
- Red stitch

1394814 12" \$46⁹⁹ DZN

TRUMP - USSSA

- .40 COR
- 325 Comp
- Synthetic cover
- Blue Stitch

1394816 12" \$46⁹⁹ DZN

TRUMP - ISA

- .44 COR
- 375 Comp
- Composite cover
- Green Stitch

1394815 12" \$46⁹⁹ DZN

FAST PITCH SOFTBALLS

(ALL TRUMP FAST PITCH SOFTBALLS ARE LEATHER COVERED)

TRUMP - NFHS

- .47 COR
- 375 Comp
- Red Stitch

1394818 12" \$62⁹⁹ DZN



TRUMP - NFHS

- .47 COR
- 375 Comp
- Red stitch

1394817 11" \$62⁹⁹ DZN



TRUMP - USSSA

- .47 COR
- 375 Comp
- Blue stitch

1394820 11" \$62⁹⁹ DZN



TRUMP - NSA

- .52 COR
- 275 Comp
- Black stitch

1394823 11" \$62⁹⁹ DZN



Bid #ESC NJ 17/18-31

Educational Services Commission of New Jersey

Athletic Equipment & Supplies



Wilson
NFHS FAST PITCH

- NFHS Approved
- COR .47 / 375 lb Max Comp.
- Poly Graphite Center
- Leather Cover
- Red SST Stitching

1371532 12" \$99⁹⁹ DZN



PERFECTION LEATHER FAST PITCH

- NFHS approved
- COR .47 / 375 lb max comp.
- Leather cover
- Poly core

1323429 12" \$89⁹⁹ DZN



ALL-WEATHER BASEBALLS

- CoreGuard™ protects the ball from getting water logged
- Dries back to original weight and condition in 24 hours
- Available in blue stitch for high school/college or red stitch for Little League

1237221 Blue Stitch - PR-0 \$49⁹⁹ DZN

SPECIALTY BALLS



UNBELIEVA-BALL

- State of the art, sting free and safe!
- Made of a high density foam core surrounded by nylon windings and a heavy duty cloth cover.
- Raised seams for a more realistic feel.
- Machine washable and long lasting.
- Perfect training aid for both indoor and outdoor play.

1300932	9" Baseball - White	\$49 ⁹⁹ DZN ★
1300949	11" Softball - Yellow	\$63 ⁹⁹ DZN ★
1300956	12" Softball - Yellow	\$64 ⁹⁹ DZN ★
1300963	12" Softball - White	\$64 ⁹⁹ DZN ★
1300970	16" Softball - White	\$13 ⁹⁹ EA ★



EASTON
SOFTSTITCH® INCREDBALL®

- INCREDBALL® sting free, safe, softwound balls with a lockstitch, double-knit cover.
- Washable, and will last as long as a regular ball.
- Carries 75% of distance when hit.
- A great training aid for indoors or outdoors.

BBSS9W 9" Baseball - White \$57⁹⁹ DZN
BBSS11Y 11" Softball - Yellow \$63⁹⁹ DZN
BBSS12Y 12" Softball - Yellow \$68⁹⁹ DZN

EASTON
SOFTTOUCH® INCREDBALL®

- Features a unique safety core for limited flight and reduced injuries
- Polyurethane core with durable synthetic leather cover
- Perfect for younger game play or indoor/outdoor training for all ages

BBST9W 9" Baseball - White \$60⁹⁹ DZN
BBST12Y 12" Softball - Neon \$68⁹⁹ DZN

MacGregor®
CHICAGO 16™

- Leather
- COR .47
- Kapok center

MCSB16CH 16" \$19⁹⁹ EA ★

PITCHING MACHINE BALLS



SUPER SOFT TRAINING BALL

- Compare to SFT™ Supersoft™ balls
- Perfect indoor training ball

1155020	9" Baseball	\$28⁹⁹ DZN ★
1155037	12" Softball	\$29⁹⁹ DZN ★



**MacGregor®
SOFT ORANGE MACHINE BALL**

- Compare to ATEC Tuffy® balls
- Developed for use with metal bats
- Softer than standard polyurethane dimple balls

1154962	9" Baseball	\$29⁹⁹ DZN ★
1154979	12" Softball	\$39⁹⁹ DZN ★



**MacGregor®
DIMPLED MACHINE BALLS**

- Soft, durable yellow polyurethane
- Designed safe for aluminum bats

MCBDBYEL	9" Baseball	\$32⁹⁹ DZN ★
BBDSBALL	12" Softball	\$38⁹⁹ DZN ★



HI.PER PRO LEATHER MACHINE BASEBALL

- Premium full grain leather balls with cushioned cork center
- High tensile strength accu-seams
- Regulation size and weight
- Aerodynamically optimized for pitching machine use

1383988		\$74⁹⁹ DZN
----------------	--	------------------------------



SEAMED PITCHING MACHINE BALLS

- Patented red seamed dimpled pitching machine ball
- Inset seams will not come in contact with machine wheels protecting red seams from wear
- Baseball appearance trains batter's eye for the real pitch

1237269	9" White Baseball	\$49⁹⁹ DZN
1237276	12" Yellow Softball	\$54⁹⁹ DZN



**MacGregor®
LITE MACHINE BALLS WITH SEAMS**

- Compare to ATEC SFT™ balls
- Ideal training ball for all ages
- Designed safe for indoor/outdoor
- Will travel as far as a regulation ball
- Works in most pitching machines

1155006	9" Baseball	\$32⁹⁹ DZN ★
1155013	12" Softball	\$38⁹⁹ DZN ★

TRAINING BALLS



HEAVY DUTY PLASTIC BASEBALL

- Heavy-duty, perforated plastic with a thicker wall structure for increased durability

Color Options: **Orange, White, Yellow.**

1050XXX	Specify Color	\$39⁹⁹ DZN
----------------	---------------	------------------------------



PLASTIC 'CURVE' BALL

Unique hole design allows for easy curveball action.

3192XXXX	12" Softball	\$1⁹⁹ EA
-----------------	--------------	----------------------------



PLASTIC TRAINING BALLS

- Designed for true slow and limited flight

1033601	9" Baseball	\$9⁹⁹ SET OF 6 ★
1033618	12" Softball	\$9⁹⁹ SET OF 6 ★



9" WIFFLE™ BALL BASEBALL

Designed for true slow and limited flight. 9" baseball size.

1141245	Wiffle™ 9" Baseball	\$1⁹⁹ EA
----------------	---------------------	----------------------------



TCB SUPER WEIGHTED BALLS

- Approx. 5.2"D - Softball size
- Weighs 900 grams
- Use for soft toss or tee work
- Strength developed

1371403	TCB Atomic Balls (set of 6)	\$68⁹⁹ SET
----------------	-----------------------------	------------------------------



TCB TRAINING BALLS

- Approx. 3.2"D - Baseball Size
- Used for soft toss, front toss and tee work
- Helps players "drive-thru" the hitting zone

1371400	Weighted	\$99⁹⁹ DZN
----------------	----------	------------------------------



TCB TRAINING BALLS

- Perfect for front toss drills
- Great for hand eye coordination
- Hits better, throws better than ordinary plastic balls
- Designed to last

1371402	With Holes - 9" Ball Size	\$32⁹⁹ DZN
	With Holes - Standard 3.2"	\$44⁹⁹ DZN



1. BUCKET W/ BASEBALLS

- Bucket with 3 dz. MacGregor 79P practice baseballs (MCB79PXX)
- 6 gallon plastic bucket w/ cushioned lid
- Holds up to 5 dz. baseballs or 2 dz. softballs

1378434	Bucket w/ balls	\$114.99 EA ★
1378375	Bucket Only	\$19.99 EA ★

2. BUCKET W/ MARK 1 BALLS

- Bucket with 3 dz Mark 1 Official League Baseballs (BSOLB)
- Heavy duty 6 gallon plastic bucket with cushioned lid

1378435	Bucket w/ balls	\$109.99 EA ★
----------------	-----------------	----------------------

3. BUCKET W/ SOFTBALLS

- 2 dz. practice softballs
- COR, compression, cover, center and brand of balls may vary.

1378432	11"	\$89.99 EA ★
1378433	12"	\$89.99 EA ★



BUCKET NOT INCLUDED

SWIVEL BUCKET SEAT

- Nylon cover with 1" thick foam cushion ++
- Swivel seat snaps onto a 12" diameter standard ball bucket ++
- Color: Black, Maroon, Red, Royal, Navy ++

K10317	Specify Color	\$42.99 EA
---------------	---------------	-------------------



COACH'S BUCKET COVER

- Includes soft cushioned top, pockets for pens & line-up cards, a zipper pocket, and a mesh pocket for three game balls

1237238		\$29.99 EA
----------------	--	-------------------



BALL BUCKET

- Holds up to 5 dz baseballs
- Padded seat for comfort

1404890		\$29.99 EA
----------------	--	-------------------



BALLS NOT INCLUDED

BATTING PRACTICE BALL CART

- Constructed of 1.5" O.D. powder coated steel
- Large capacity basket
- Oversized "no flat" tires

1378683		\$24.99 EA ★
1375102	Replacement Wheel	



BALLS NOT INCLUDED

FOLDABLE BALL BIN

- Waist high ball bin-ideal for soft toss or normal BP
- Foldable design allows for easy storage

1361841		\$79.99 EA ★
----------------	--	---------------------



ADJUSTABLE FIELD BALL CART

- Heavy duty molded plastic hopper and large rear wheels for easy mobility
- Legs are height adjustable to raise/lower hopper height

1237207		\$424.99 EA
----------------	--	--------------------

BATTING TEES



UTILITEE STAND COMPLETE

- All-weather, urethane upper and steel lower shaft for superior impact resistance
- Adjustable from 24" - 42"
- Durable steel collapsible tripod legs and easily fits over any home plate
- Available with a brush top, mesh top or wrap top
- Optional attachment pack includes: Classic Brush Top, Perfect Cut, Cast-away, In and out, protective caps and carry case

1384022	Specify Top	\$89 ⁹⁹ EA
1384025	Attachment Pack	\$89 ⁹⁹ EA



MacGregor OFFICIAL BATTING TEE

- Constructed of durable rubber components
- Features a solid metal base for added weight
- Adjustable hitting height from 20" to 36"
- Ideal for training players of all ages

BBBATTEE	Black Tee	\$29 ⁹⁹ EA ★
BBBATTUB9	Black Replacement Inside Tube	\$7 ⁹⁹ EA ★



TRAVEL TEE

- Lightweight, portable hitting tool for baseball or softball
- Breaks down for easy transport
- Telescoping tee allows you to adjust the height of the tee (29"-47")
- Includes a water-resistant carrying bag

512830600	Complete Travel Tee	\$41 ⁹⁹ EA
1036978	Replacement Top	\$9 ⁹⁹ EA



BATTING TEE

- Outstanding durability and portability
- Polyethylene base with adjustable shaft
- Flexible fiber top shaft and rubber cup

1375574	22" - 41"	\$124 ⁹⁹ EA
1375575	26" - 53"	\$129 ⁹⁹ EA
1375576	Low Ball Attachment - 16"H	\$37 ⁹⁹ EA
1375577	Low Ball Attachment - 19"H	\$39 ⁹⁹ EA
1375578	Extra Rubber Cup	\$25 ⁹⁹ EA
1375579	Optional 10lb weight plate	\$25 ⁹⁹ EA



TANNER TEE

- Steel shaft has telescoping height adjustment
- Flexible ball rest for minimal resistance
- Breaks down easy for travel

1384015	Standard Tee (26"-43")	\$79 ⁹⁹ EA
1384016	Short Tee (20"-32")	\$79 ⁹⁹ EA



VARSITY 5 POSITION BATTING TEE

- Rugged hard-rubber construction
- Learn to control ball contact points for inside, outside and down the middle
- Allows over 20 different drill positions
- Adjustable from 20" - 39"

10 Year Limited Warranty

1154818	Complete Tee	\$59 ⁹⁹ EA ★
1249897	Replacement Top Tube	\$9 ⁹⁹ EA ★



TUFFY TEE

- High strength polyurethane materials for unmatched durability
- Adjusts from 20" to 39"

10 Year Limited Warranty

TUFFTEE1	Single Tee	\$149 ⁹⁹ EA
-----------------	------------	------------------------



THE PVTEE

- Flexible pivot joint will have the tee back to the upright position before you are ready to put the next ball on
- Pivot joint allows impact of mis-hits to be realized in the joint and not the other tee components
- Flexible pivot joint takes impact away from batters hands and helps eliminates bat damage
- Unique magnet allows the tee to break down in one second
- Weighted base holds tee in place

1393592	Standard Tee (27"-47")	\$119 ⁹⁹ EA
1393597	Low Stem Only (20"-26")	\$54 ⁹⁹ EA



BASEBALL/SOFTBALL

Bid #ESC NJ 17/18-31

Educational Services Commission of New Jersey

Athletic Equipment & Supplies



E50 BAT PACK

- Fence hook for dugout functionality
 - Padded shoulder straps
 - Side pouch for bats or water bottles
 - Front pocket for personal items
- Color Options: **Black, Red, Royal.**

EAA159026 18"H x 12"W x 7"D **\$29⁹⁹** EA



NEW!

marucci CHARGE BAT PACK

- Padded foam back
 - Full rubberized bottom
 - Exposed foam backpack strap area
 - Soft mesh carry handle
- Color Options: **Grey/Gold, Grey/Black, Grey/Navy, Grey/Red, Grey/Royal.**

1450695 13"W x 12"D x 20"H **\$89⁹⁹** EA



E110 BAT PACK

- Vented shoe compartment
 - Padded back and shoulder straps
 - Fence hook for dugout functionality
- Color Options: **Black, Green, Ion Yellow, Maroon, Navy, Orange, Purple, Red, Realtree, Royal, Stars and Stripes, White, White/Purple.**

EAA159019 19"H x 13"W x 8"D **\$49⁹⁹** EA



NEW!

Rawlings VELO BACKPACK

- Holds 2 bats
 - Customizable top valet tray
 - Fleece lined zipper-in valet tray for phone
 - Main storage compartment with additional smaller internal pockets
 - Fence hooks
- Color Options: **Black, Dark Green, Graphite, Maroon, Navy, Purple, Royal, Scarlet.**

RWVELOBK 19.5"H x 17"W x 9"D **\$69⁹⁹** EA



NEW!

EASTON CATCHER'S BACKPACK

- Vented main compartment to fit catcher's gear
- Separate vented cleat compartment
- Two fully lined bat sleeves
- External strap and buckle for attaching helmet or glove

EAA159029 25"H x 15"W x 10"D **\$99⁹⁹** EA



Wilson PUDGE 2.0 EQUIPMENT BAG

- Extra large main compartment
 - Fits 4 bats
 - Telescopic pull handle with zip cover
 - Removable decoration panel
 - Wheel chassis with 3" clearance
- Color Options: **Black, Navy, Royal, Scarlet.**

WLWT9721 39"L x 16.5"W x 13"H **\$159⁹⁹** EA



COVERT PLAYER EQUIPMENT BAG

- Removable top panel for personalization
 - Ventilated shoe compartment
 - Side bat sleeve compartments
- Color Options: **Black, Navy, Royal, Scarlet.**

1377668 26"L x 13"W x 13"H **\$54⁹⁹** EA



NEW!

EASTON WALK-OFF IV BACKPACK

- Felt lined top pocket for personal items
 - Two side bat sleeves with personal zippered pockets
 - Padded back and shoulder straps for comfort
 - Fence hook for dugout functionality
- Color Options: **Black, Green, Grey/Orange, Grey/Yellow, Maroon, Navy, Orange, Purple, Red, Royal, Stars and Stripes, White.**

EAA159027 20"H x 14"L x 9.5"W **\$69⁹⁹** EA



DeMARINI MOMENTUM WHEELED BAG

- Large main compartment for gear
 - Holds up to 4 bats
 - Removable decoration panel
 - Rugged wheels
 - J style fence hook
- Color Options: **Black, Charcoal, Dark Green, Light Gold, Maroon, Navy, Orange, Purple, Royal, Scarlet.**

WLWT9406 36"L x 11"W x 10.5"H **\$84⁹⁹** EA



CATCHER'S EQUIPMENT BAG

- Features 600 denier polyester
- Heavy duty shoulder and handle straps
- Black only

512815506 35"L x 25"W x 19"H **\$39⁹⁹** EA



MX EQUIPMENT WHEEL BAG

- Accessory compartment for valuables
- Durable off-road wheels
- Retractable Handle
- Holds up to 4 bats

MZ360178 36"L x 15"W x 15"H **\$99⁹⁹** EA



E510W WHEELED EQUIPMENT BAG

- Reinforced bottom to avoid premature wearing
 - Heavy-duty bracketed inline wheels for stability
 - Reinforced straps for better weight distribution
 - Holds 4 bats
- Color Options: **Black, Green, Maroon, Navy, Orange, Pro Blue,**

EAA159017 36"L x 12"W x 12"H **\$59⁹⁹** EA



EQUIPMENT BAGS

BSN SPORTS



TEAM EQUIPMENT BAG

- Heavy duty polyester equipment bag
- Rugged nylon zipper with wrap around handles
- Black only

1377678 33"L x 12"W x 15"H **\$19.99** EA ★



TEAM DUFFEL BAG

- Zip close compartments on both ends
- Double handle carry straps
- Padded shoulder harness
- Denier nylon with breathable air vents
- Black only

1377672 27"L x 14"W x 12"H **\$29.99** EA ★
1377675 24"L x 12"W x 10"H **\$26.99** EA ★



VARSITY BAT BAG

- Tough vinyl material with a molded plastic round bottom
- The plastic bottom helps prevent tearing caused by dragging the bag
- Can hold up to 10 bats
- Black only

1385396 41"L x 10"W **\$27.99** EA ★



LARGE DUFFEL EQUIPMENT BAG

- Durable 600 denier polyester bag with a thick web shoulder strap and handle
- Military style closure
- Black only

1385397 33"L x 18"W **\$26.99** EA ★



BASEBALL/SOFTBALL EQUIPMENT TOTE

- Strong 600 denier polyester
- Will hold 15 bats and has a zippered top for easy closing
- Separate zippered outside pocket for softballs or baseballs
- Double reinforced bottom with standard shoulder straps
- Black only

1385398 39"L x 12"W **\$36.99** EA ★



BALL BAG

- Coated nylon with heavy duty carrying straps and zippered top
- Durable plastic bottom provides long lasting protection against water damage and mildew
- Holds 48 baseballs or 24 softballs
- Black only

1385399 **\$26.99** EA ★



XL DUFFEL EQUIPMENT BAG

- Breathable heavy duty cotton canvas
- Durable leather reinforced bottom
- Complete with shoulder strap and handle
- Black only

1385404 42"L x 20"W **\$29.99** EA ★



PLAYERS BAT PACK

- Mid-sized backpack
- External side sleeves
- Interior room for a batting helmet and other gear
- 600D polyester construction
- Black only



1385392 14"L x 10"W x 19"H **\$19.99** EA ★



CATCHER'S EQUIPMENT BAG

- Heavy duty 600D polyester construction
- Professional strength carry straps
- Black only

1385403 NJ State Approved Co-op #65MCECCPS Metuchen/Garden State Apparel Bid Term: 5/9/18 - 5/8/20: Extended to

TEAM ROLLER BAG

- 600 denier polyester shell
 - Concealed pull handle
 - Padded shoulder strap
 - In-line wheel kit
 - Oversized accessory pockets on both ends
- Color Options: **Black, Royal, Scarlet.**



Rawlings
VENTED BATTING HELMETS

- Meets revised NOCSAE standards
- Sleek design with superior venting system
- One size fits most with self adjusting fit
- ABS shell with dual density foam
- Pre-drilled for facemask
- Black only

1383944	Junior (6 1/4 - 6 7/8)	\$18 ⁹⁹ EA
1383945	Youth (6 1/2 - 7 1/2)	\$18 ⁹⁹ EA
1383946	Youth w/Attached Mask (6 1/2 - 7 1/2)	\$27 ⁹⁹ EA
RWBB1WG	Baseball Face Guard (Black Only)	\$17 ⁹⁹ EA
RWSB1WG	Softball Face Guard (Black Only)	\$17 ⁹⁹ EA
1391923	Elastic Chin Straps (dz)	\$29 ⁹⁹ DZN



Rawlings
MATTE BATTING HELMETS

- Meets revised NOCSAE standards
- Matte finish
- Sleek design with superior venting system
- One size fits most with self adjusting fit
- ABS shell with dual density foam
- Pre-drilled for facemask

Color Options: **Black, Royal, Scarlet.**

1383956	Junior (6 1/4 - 6 3/4)	\$26 ⁹⁹ EA
1383959	Youth (6 1/2 - 7 1/2)	\$26 ⁹⁹ EA
RWBB1WG	Baseball Face Guard (Black Only)	\$17 ⁹⁹ EA
RWSB1WG	Softball Face Guard (Black Only)	\$17 ⁹⁹ EA
1391923	Elastic Chin Straps (dz)	\$29 ⁹⁹ DZN



Rawlings
CFABHN BATTING HELMET

- Exclusive XV1 venting technology to allow cooler air flow
- ABS plastic shell with dual density foam padding
- Optic orange crown liner and leather wrapped headband
- Clear coat finish
- SM (6 7/8 - 7) MD (7 1/8 - 7 1/4)
- LG (7 3/8 - 7 1/2) XL(7 5/8 - 7 3/4)

Color Options: **Black, Navy, Red, Royal**
Size: **SML, MED, LRG, XLG.**

1385391	Specify Size & Color	\$39 ⁹⁹ EA
----------------	----------------------	-----------------------



EASTON
Z5 GRIP BATTING HELMET

- Meets revised NOCSAE standards
 - Matte finish
 - Dual-density shock absorbing foam
 - Bio-dri liner helps absorb sweat
- Color Options: **Black, Gold, Green, Maroon, Navy, Orange, Purple, Red, Royal, Texas Orange, Vegas Gold, White.**

1385259	Junior (6 3/8 - 7 1/8)	\$44 ⁹⁹ EA
1385245	Senior (6 7/8 - 7 5/8)	\$44 ⁹⁹ EA



RIP-IT
VISION PRO BATTING HELMET W/ MASK

- NOCSAE approved fastpitch Softball Helmet
- Blackout technology reduces glare
- S/M fits sizes 6 - 6 7/8; M/L fits sizes 6 1/2 - 7 3/8; XL fits size 7 1/4+
- Size: **M/L, XL, S/M**
- Color Options: **Away-Black, Away-Lt Blue, Away-Purple, Away-Royal, Away-Scarlet, Home-Black, Home-Lt Blue, Home-Purple, Home-Royal, Home-Scarlet, Home-Green, Home-Maroon, Home-Navy, Home-Orange.**

1385315	Specify Size and Color	\$59 ⁹⁹ EA
----------------	------------------------	-----------------------



NEW!
Rawlings
VELO R16 SERIES BATTING HELMET

- Matte / carbon fiber design
- Meets NOCSAE standards
- Wrapped jawpads for improved comfort and fit
- Senior (6 1/2 - 7 3/8)
- Junior (6 3/8 - 7 1/8)

Color Options: **Matte Black, Matte Dk Green, Matte Graphite, Matte Navy, Matte Royal, Matte Scarlet.**

RWR16CFJ	Senior	\$59 ⁹⁹ EA
RWR16CFS	Senior	\$59 ⁹⁹ EA



EASTON
Z5 GRIP TWO TONE BATTING HELMET

- Meets revised NOCSAE standards
- High impact resistance providing an excellent protective shell
- High density shock absorbing foam
- Bio-dri liner helps absorb sweat
- Matte finish

Color Options: **Black/White, Green/White, Maroon/White, Navy/White, Orange/White, Purple/White, Red/White, Royal/White, White/Black.**

1385276	Senior (6 7/8 - 7 5/8)	\$49 ⁹⁹ EA
----------------	------------------------	-----------------------



Rawlings
RCFH OSFM BATTING HELMET

- Meets NOCSAE standards
 - Molded finish
 - Traditional COOLFLO design
 - Pre-drilled for face guard
- Color Options: **Black, Dark Green, Navy, Royal, Scarlet, White.**

1391875	OSFM (6 1/2 - 7 1/2)	\$22 ⁹⁹ EA
RWBB1WG	Baseball Face Guard (Black Only)	\$17 ⁹⁹ EA
RWSB1WG	Softball Face Guard (Black Only)	\$17 ⁹⁹ EA



Rawlings

TWO TONE (HOME) BATTING HELMET

- Metallic/matte paint finish
 - 16 vent design to enhance the overall cooling effect
 - Wrapped jawpad for improved comfort
- Color Options: **Black, Crimson, Dark Green, Maroon, Navy, Purple, Royal, Scarlet, Silver, Texas Orange, Vegas Gold.**

RWR16H2S	Senior (6 7/8 - 7 5/8)	\$49 ⁹⁹ EA
RWR16H2J	Junior (6 3/8 - 7 1/8)	\$49 ⁹⁹ EA

Rawlings

TWO TONE (AWAY) BATTING HELMET

- Metallic/matte paint finish
 - 16 vent design to enhance the overall cooling effect
 - Wrapped jawpad for improved comfort
- Color Options: **Black, Crimson, Dark Green, Maroon, Navy, Purple, Royal, Scarlet, Silver, Texas Orange, Vegas Gold.**

RWR16A2S	Senior (6 7/8 - 7 5/8)	\$49 ⁹⁹ EA
RWR16A2J	Junior (6 3/8 - 7 1/8)	\$49 ⁹⁹ EA

Rawlings

VELO TWO TONE BATTING HELMET W/ MASK

- Matte finish
 - 16 vent design for enhanced cooling
 - Wrapped jawpads for improved comfort and fit
- Color Options: **Black, Columbia Blue, Crimson, Dark Green, Maroon, Navy, Purple, Royal, Scarlet, Silver, Texas Orange, Vegas Gold.**

RWRH2FGS	Senior (6 7/8 - 7 5/8)	\$59 ⁹⁹ EA
RWRH2FGJ	Junior (6 3/8 - 7 1/8)	\$59 ⁹⁹ EA



NEW!

DeMARINI PARADOX BATTING HELMET

- Rubberized matte finish
 - Low profile shell for superior fit
 - YTH (6 1/2 and below)
 - S/M (6 3/8 - 7 1/8) L/XL (7 - 7 5/8)
- Size: **YH, SM, LX**
Color Options: **Black, Charcoal, Navy, Royal, Scarlet, White.**

WLWTD5403	Specify Size & Color	\$29 ⁹⁹ EA
------------------	----------------------	-----------------------

DeMARINI PARADOX FITTED PRO BATTING HELMET W/ MASK

- Premium matte finish
 - Low profile shell for superior fit
 - Dual density foam padding
 - XS(6 5/8 - 6 3/4); SM(6 7/8 - 7); MD(7 3/8 - 7 1/4)
 - LG(7 3/8 - 7 1/2); XL(7 5/8 - 7 3/4); XXL(7 7/8 - 8)
- Size: **XS, SML, MED, LRG, XLG, 2XL**
Color Options: **Black, Charcoal, Navy, Royal, Scarlet, White.**

WLWTD5421	Specify Size & Color	\$54 ⁹⁹ EA
------------------	----------------------	-----------------------

NEW!

DeMARINI PARADOX PROTEGE BATTING HELMET W/ MASK

- Dual density padding
 - Glossy finish
 - Low profile shell for superior fit
 - Strategic venting system to keep the head cool
 - Youth (6 1/2 and below)
 - S/M (6 3/8 - 7 1/8)
 - L/XL (7 - 7 5/8)
- Color Options: **Black, Charcoal, Navy, Royal, Scarlet, White**
Size: **YH, SM, LX.**

WLWTD5424	Specify Size & Color	\$34 ⁹⁹ EA
------------------	----------------------	-----------------------

CATCHER'S HELMETS



TWO-TONE CATCHER'S HELMET

- Meets revised NOCSAE standards
- Meets all NFHS requirements
- Sleek two-toned design and fit
- Clearview wire design for optimum visibility
- Multiple air vents
- Adjustable back plate

Color Options: **Black, Royal, Scarlet.**

1383965 Varsity (7 1/8 - 7 3/4) **\$79⁹⁹** EA
1383968 Youth (6 1/2 - 7) **\$69⁹⁹** EA



HOCKEY STYLE CATCHER'S HELMET

- Meets revised NOCSAE standards
- Hockey style design - features rugged, durable ABS shell
- Dual foam liner with vents large air vents
- One size fits most

Color Options: **Black, Royal, Scarlet.**

1383962 Fits Sizes 6 1/2 - 7 1/2 **\$49⁹⁹** EA



VENTED CATCHER'S HELMET/MASK

- ABS vented shell with attached hollow-wire mask
- Sizes: small (6-5/8 - 7-1/2); large (7 - 7-3/4)

1035940 Specify Size & Color **\$49⁹⁹** EA



THROAT PROTECTOR

- Molded high-impact ABS plastic
- Hook-and-Loop fastens onto mask
- Fits all makes of masks

Color Options: **Royal, Scarlet, Black, Navy.**

MCB22Y 4" long **\$3⁹⁹** EA ★

MacGregor CHEST PROTECTORS

All available in **BLACK ROYAL SCARLET**



MCB75 JUNIOR CHEST PROTECTOR

1298345 Ages 5 to 8 **\$35⁹⁹** EA ★



MCB74 YOUTH CHEST PROTECTOR

1298376 Ages 9 to 12 **\$39⁹⁹** EA ★



MCB73 PREP CHEST PROTECTOR

1298406 Ages 13 to 15 **\$44⁹⁹** EA ★



MCB70 PRO CHEST PROTECTOR

1298437 Ages 15+ **\$49⁹⁹** EA ★



MCB80/81 FEMALE CHEST PROTECTORS

1298475 Varsity **\$44⁹⁹** EA ★
1298505 Youth **\$38⁹⁹** EA ★

MacGregor LEG GUARDS

All available in **BLACK ROYAL SCARLET**

DOUBLE KNEE



SINGLE KNEE



B62 JUNIOR SINGLE KNEE

- 9" shin plate
- Protection area of 18"
- Black only

1159318 Ages 5-8 **\$29⁹⁹** PR ★

B66 PREP DOUBLE KNEE

- 11" shin plate
- Full-wing ankle protectors
- Protection area of 25"

1159400 Ages 12-15 **\$44⁹⁹** PR ★

B68 JUNIOR DOUBLE KNEE

- 9" shin plate
- Protection area of 20"

1159431 Ages 5-8 **\$39⁹⁹** PR ★

B61 VARSITY DOUBLE KNEE

- 12" Shin plate
- Full ankle and calf wing

1159288 Ages 15+ **\$59⁹⁹** PR ★

B64 YOUTH DOUBLE KNEE

- 10" shin plate.
- Protection area of 23".

1159345 Ages 9-12 **\$42⁹⁹** PR ★

LEG GUARD REPLACEMENT STRAPS

Replacement straps for catcher's leg guards. Black only.

1184747 Adult Size **\$16⁹⁹** PR ★
1184754 Youth Size **\$19⁹⁹** PR ★



CATCHER'S KNEE SUPPORT

- Supports and cushions the knee, minimizing the stress on the knee in the catcher's position
- Attach to the leg guard straps
- Black only

All available in **BLACK** **ROYAL** **SCARLET**

CATCHER'S GEAR PACKS



\$99⁹⁹

JUNIOR CATCHER'S GEAR PACK

- Adjustable catcher's helmet
- MCB75 junior chest protector
- Junior double knee leg guards
- 4" throat protector

1186895 Ages 5-8 **\$99⁹⁹** PACK ★



\$109⁹⁹

YOUTH CATCHER'S GEAR PACK

- Adjustable catcher's helmet
- MCB74 youth chest protector
- Youth double knee leg guards
- 4" throat protector

1186833 Ages 9-12 **\$109⁹⁹** PACK ★



\$159⁹⁹

PREP CATCHER'S GEAR PACK

- Pro style varsity catcher's helmet
- MCB73 prep chest protector
- Prep double knee guards
- 4" throat protector

1186864 Ages 12-15 **\$159⁹⁹** PACK ★



\$179⁹⁹

VARSITY CATCHER'S GEAR PACK

- Pro-style varsity catcher's helmet
- MCB70 varsity chest protector
- Varsity double knee leg guards
- 4" throat protector

1186802 Ages 15+ **\$179⁹⁹** PACK ★



GIRL'S FAST PITCH CATCHER'S GEAR PACK

- Package Includes:
- Adjustable catcher's combo helmet
 - MCB81 girls chest protector
 - Youth double knee leg guards
 - 4" throat protector

\$109⁹⁹

1186956 Ages 9-13 **\$109⁹⁹** PACK ★



VARSITY FAST PITCH CATCHER'S GEAR PACK

- Package includes:
- Pro style varsity catcher's helmet
 - MCB80 varsity female chest protector
 - Prep double knee leg guards
 - 4" throat protector

\$159⁹⁹

1186925 Ages 14+ **\$159⁹⁹** PACK ★

FAST PITCH CATCHER'S EQUIPMENT

YOUTH CATCHER'S EQUIPMENT



EASTON M7 FAST PITCH CATCHER'S SET

- Includes fast pitch catcher's helmet, M7 chest protector and leg guards
- Age 13-15 set includes helmet (6 1/8" - 7"); 15" chest protector and 15.5" leg guards
- Age 9-12 set includes helmet (6 1/8" - 7"); 13" chest protector and 14" leg guards

Color Options: **Black, Navy, Red, Royal.**

1391858 NJ State Approved Co-op #65MCESSCP5 Munchen/Garden State AppareBid Term: 5/9/18 - 5/8/20: Extended to 5/8/21 **\$199⁹⁹** EA

1391862 Age 9-12 **\$199⁹⁹** EA



NEW!

EASTON

M5 QWIKFIT CATCHERS BOX SET

- Includes M5 helmet, chest protector and leg guards
- Junior available in **BLACK ONLY**
- Youth (helmet 6 1/8-7), chest protector (14"), leg guards (13.5")
- Junior (helmet 6 1/8-7), chest protector (12"), leg guards (12.5")

Color Options: **Black, Navy, Red, Royal.**

EA165342 Youth Ages 9-12 **\$154⁹⁹** EA

EA165378 Junior Ages 6-8 **\$154⁹⁹** EA

BASEBALL/SOFTBALL

CATCHER'S GEAR**VELO TWO TONE CATCHER'S HELMET**

- Hockey style design
- Moisture wicking padding for better fit and comfort
- High strength, impact resistance cage
- Matte finish with clear coat
- Adjustable back plate for custom fit
- Meets NOCSAE standards

RWCHVEL	Adult (7 1/8" - 7 3/4")	\$119.99 EA
RWCHVELY	Youth (6 1/2" - 7")	\$109.99 EA

VELO CHEST PROTECTOR

- Impact absorbing foam provides optimal ball control
- Lightweight and flexible design provides unrestricted motion
- Adjustable and removable shoulder caps
- Adjustable back harness for a custom fit

RWCPVEL	Adult - 17"	\$119.99 EA
RWCPVELI	Intermediate - 15.5"	\$119.99 EA

VELO LEG GUARDS

- Impact absorbing foam in the knee
- Conforming lightweight design for comfort and mobility
- Adjustable internal padding for moisture management and comfort
- Triple knee design for protection
- Over the shoe elastic strap on toe flap

RWLGVEL	Adult - 16.5"	\$124.99 EA
RWLGVELI	Intermediate - 15.5"	\$124.99 EA

AVAILABLE COLORS

Black/Graphite, Black/Orange, Black/Scarlet, Crimson/White, Dark Green/White, Maroon/White, Navy/Scarlet, Navy/White, Purple/White, Royal Blue/Scarlet, Royal Blue/White, Scarlet/White, White/Silver.

**M10 CUSTOM CATCHERS SET**

- Premium catcher's gear box set
- Adult set includes helmet (7" - 7 7/8"); 16.5" chest protector and 17" leg guards
- Intermediate set includes helmet (6 1/8" - 7 3/8"); 14.5" chest protector and 14" leg guards
- Youth set includes helmet (6 1/8" - 7 3/8"); 12.5" chest protector and 12.75" leg guards

EAA165339	Adult (Ages 16 & Up)	\$309.99 EA
EAA165340	Intermediate (Ages 13-15)	\$299.99 EA
EAA165341	Youth (Ages 9-12)	\$279.99 EA

AVAILABLE COLORS

Black/Black, Black/Gold, Black/Green, Black/Orange, Black/Purple, Black/Red, Black/Royal, Black/Silver, Black/Turquoise, Black, Cardinal/Silver, Green/Gold, Green/Silver, Maroon/Gold, Maroon/Silver, Navy/Columbia Blue, Navy/Gold, Navy/Red, Navy/Silver, Navy/White, Navy, Purple/Gold, Red/Navy, Red/Silver, Red/White, Royal/Red, Royal/Silver, Royal/White, Red, Royal

**NEW!****RIP-IT****DEFENSIVE FACE GUARD**

- Seamless detachable visor
- Blackout technology eliminates glare
- Ultra- light weight.
- Colors: Black, Scarlet, Royal, Navy, and White

1323818	Adult	\$49.99 EA
---------	-------	-----------------------

Bid #ESCNJ 17/18-31
MacGregor UMPIRE EQUIPMENT

Educational Services Commission of New Jersey Athletic Equipment & Supplies

BASEBALL/SOFTBALL



UMPIRE ACCESSORY PACK

- Boxed set includes:
- Plate brush (MCB91XXX)
 - Ball bag (balls not included)
 - 4-way indicator

MCUMPKIT	Complete Pack	\$15 ⁹⁹ PACK ★
MCB94XXX	Bag Only	\$8 ⁹⁹ EA ★
MCB91XXX	Plate Brush Only	\$7 ⁹⁹ EA ★



COMPLETE UMPIRE PACK

- Box Set includes:
- B29 Pro 100 mask (MCB29BXX)
 - MCB79 inside chest protector
 - MCB67 leg guards
 - Ball bag (balls not included)
 - Plate brush
 - 4-way indicator (BBUMPIN4)

MCUMPSET \$134⁹⁹ PACK ★

MacGregor MCB29 PRO MASK

- Hollow tubular steel frame
- Lighter than traditional masks
- Durable vinyl coating with extended ear and throat guard
- Complete with harness



MCB29BXX With Black Vinyl Pads \$46⁹⁹ EA ★



MCB78 OUTSIDE CHEST PROTECTOR

- Filled with 3" thick lightweight foam
- Adjustable shoulder straps with vinyl neck rest
- Features a built in ball pocket

MCB78BXX Size: 21 1/2" L \$46⁹⁹ EA ★



MCB79 INSIDE CHEST PROTECTOR

- Super light weight
- Wrap-around throat pad
- Extended upper shoulder ribs

MCB79BXX Size: 16.5" L \$56⁹⁹ EA ★



PRO UMPIRE SHIRT

- 100% polyester
- Reinforced front pocket
- Rib knit collar and cuffs

Size: MED, LRG, XLG.

CUMPRO	Navy - MD-XL	\$38 ⁹⁹ EA ★
CUMPROXX	Navy - XXL	\$38 ⁹⁹ EA ★
CUMPROXXX	Navy - XXXL	\$39 ⁹⁹ EA ★
LBUMP	Lt Blue - MD-XL	\$37 ⁹⁹ EA ★
LBUMPXXL	Lt Blue - XXL	\$38 ⁹⁹ EA ★
LBUMPXXX	Lt Blue - XXXL	\$39 ⁹⁹ EA ★



Diamond

DCP-IX3 UMPIRE CHEST PROTECTOR

- Lightweight iX3 breathable technology
- CoolMax fabric for moisture management
- Adjustable arm pads
- Removable sizing plate included

1291506 14" L w/o sizing plate; 18.5" w/ plate \$97⁹⁹ EA



MacGregor MCB67 UMPIRE'S LEG GUARDS

- Molded ABS construction
- Durable close-cell foam
- Fully padded ankle and instep
- 12" shin plate

MCB67XXX Black only \$39⁹⁹ PR ★



MacGregor UMP'S INDICATOR

- Records balls, strikes, outs

BBUMPIND	Plastic	\$5 ⁹⁹ EA ★
BBUMPSTL	Steel	\$6 ⁹⁹ EA ★

4 WAY UMPIRES INDICATOR

- Plastic indicator
- Records balls, strikes, outs and innings.

BBUMPIN4 \$4⁹⁹ EA ★



SHORT BILL UMPIRE CAP

- Polywool umpires cap with 1-1/2" short bill
- Adjustable hook/loop back

BBUCSBNV Fits sizes 6 7/8" - 7 1/4" \$14⁹⁹ EA

DLG-IX3 UMPIRE LEG GUARDS

- Vented iX3 padding
- Floating middle knee
- Locking J-hooks
- Removable toe extension

1291513 Specify size \$69⁹⁹ PR



Bid #ESCNJ 17/18-31

Educational Services Commission of New Jersey

Athletic Equipment & Supplies

Rawlings **GLOVES****EASTON GLOVES****NEW!****SELECT PRO LITE SERIES - 12"**

- Pro H web design
- Conventional back
- Youth pro taper fit pattern
- Bryce Harper design model

RWSPL120 Specify LHT or RHT **\$59⁹⁹** EA**PLAYER PREFERRED 12.5"**

- Single post, double-bar web design
- Conventional back
- Full grain leather for enhanced durability
- Quick, easy break-in for a game ready feel

RWPBDC1 Specify LHT or RHT **\$69⁹⁹** EA**PLAYER PREFERRED CATCHER'S MITT - 30"**

- Target catcher's mitt
- 1 piece solid web design
- Conventional back
- Improved fit with pull straps closures

RWPCM30T Specify LHT or RHT **\$74⁹⁹** EA**NEW!****SANDLOT SERIES CATCHER'S MITT - 33"**

- 1 piece solid web design
- Conventional back
- Full grain oil shell leather design for durability
- Zero shock palm pads for extra protection

RWSCM33530 RHT Only **\$74⁹⁹** EA**NEW!****GAMER FP CATCHER'S MITT - 33"**

- Modified Pro H design
- Custom fit, adjustable pull strap back
- Designed for the elite softball player
- Padded thumb loop for soft, comfortable feel

RWGSBCM33 Specify LHT or RHT **\$139⁹⁹** EA**NEW!****GAMER FP FIRST BASE MITT - 12.5"**

- Modified Pro H web
- Overlapping fastback design
- Specifically designed for the elite softball player

RWGSBFBM Specify LHT or RHT **\$109⁹⁹** EA**NEW!****GAME DAY CATCHERS MITT - 33"**

- Double oiled cowhide tanned mitt
- Super soft sponge-tricot finer lining
- Oiled palm lining

EAA130669 RHT Only **\$89⁹⁹** EA**NEW!****GAME DAY 1ST BASE MITT - 12.75"**

- 10% player break-in
 - Cowhide tanned super soft and game ready
 - Tricot finger lining
- Color Options: LHT, RHT.

EAA130670 Specify LHT or RHT **\$89⁹⁹** EA**NEW!****CORE PRO FP CATCHERS MITT - 33"**

- Hand oiled leather palm liner
 - Professional patterns and web designs
 - Wide/deep pocket design, ideal for softball
- Color Options: LHT, RHT.

EAA130643 Specify LHT or RHT **\$109⁹⁹** EA**NEW!****SYNERGY ELITE FP CATCHER'S MITT - 33"**

- Soft, durable and structurally sound leather
- Palm lining
- Lock-Down wrist strap

EAA130562LHT33 Specify LHT or RHT **\$79⁹⁹** EA**NEW!****SYNERGY ELITE FP 1ST BASE MITT - 13"**

- Oiled hide palm lining
- Lock down wrist strap
- Optimized for the smaller female hand
- Sponge tricot finger lining

EAA130563 Specify LHT or RHT **\$84⁹⁹** EA**NEW!****SALVO SP INFIELD/OUTFIELD - 13"**

- Double deep pocket design
- Lockdown wrist strap
- VRS shock absorbing palm padding

EAA130539 Fits Left Hand **\$69⁹⁹** EA
EAA130539 Fits Right Hand **\$69⁹⁹** EA

Bid #ESCNJ 17/18-31

Educational Services Commission of New Jersey

Athletic Equipment & Supplies

MacGregor GLOVES & MITTS



12" SCHOLASTIC FIELDER'S GLOVE

- Leather palm and webbing
- Synthetic backing
- Adjustable wrist strap
- Ideal for baseball and softball

BBBGVARX	Fits Left Hand	\$33 ⁹⁹	EA ★
BBBGVARR	Fits Right Hand	\$33 ⁹⁹	EA ★



12.5" VARSITY FIELDER'S GLOVE

- Pre-oiled leather construction
- Open web design
- Quick and easy break in
- Ideal for infield or outfield

MCFG125X	Fits Left Hand	\$49 ⁹⁹	EA ★
MCFG125R	Fits Right Hand	\$49 ⁹⁹	EA ★



12.5" YOUTH FIELDER'S GLOVE

- Leather palm and webbing
- Synthetic backing
- Adjustable wrist strap
- Open web design

BBMESHXX	Fits Left Hand	\$29 ⁹⁹	EA ★
BBMESHXR	Fits Right Hand	\$29 ⁹⁹	EA ★



13.5" FIELDER'S GLOVE

- Selected cowhide palm and back
- Leather lining and lacing
- Finger hole & adjustable strap
- Open web design

BBFSPROX	Fits Left Hand	\$58 ⁹⁹	EA ★
BBFSPROR	Fits Right Hand	\$58 ⁹⁹	EA ★

FAST PITCH

FIRST BASE



34" FASTPITCH CATCHER'S MITT

- Pre-oiled full grain leather w/ rawhide lacing
- Pre-formed for easy break-in
- Large softball pattern with dual "H" post web design
- Exclusive PROLOCK hook-and-loop fastener wrist closure

MCCM300X	Fits Left Hand	\$69 ⁹⁹	EA ★
-----------------	----------------	--------------------	------



12.5" 1ST BASE MITT

- All leather construction
- Pre-oiled for short break-in period
- Top quality first base mitt for youth through high school

MCFB100X	Fits Left Hand	\$58 ⁹⁹	EA ★
MCFB100R	Fits Right Hand	\$58 ⁹⁹	EA ★



10.5" TEE BALL GLOVE

- Soft synthetic leather construction for easy break in
- Rawhide lacing for added durability
- Adjustable wrist strap
- Ideal for t-ball and youth baseball.

BBFGTBXX	Fits Left Hand	\$19 ⁹⁹	EA ★
BBFGTBRX	Fits Right Hand	\$19 ⁹⁹	EA ★

MacGregor GLOVES & MITTS



33.5" VARSITY CATCHER'S MITT

- High grade pre-oiled leather
- Exclusive major league design
- Ideal for varsity to adult players

MCCM200X	Fits Left Hand	\$76 ⁹⁹	EA ★
-----------------	----------------	--------------------	------



33" PREP CATCHER'S MITT

- Top quality pre-oiled leather
- Scoop toe design
- Deep grip pocket
- Ideal for ages 12-15

MCCM100X	Brown- Fits Left Hand	\$59 ⁹⁹	EA ★
MCCM10TX	Black- Fits Left Hand	\$59 ⁹⁹	EA ★



32" YOUTH CATCHER'S MITT

- Full grain leather
- Pre-oiled for easy break in
- Deep pocket and scoop toe design
- Ideal for ages 9-12.

BBCMPROX	Fits Left Hand	\$59 ⁹⁹	EA ★
BBCMPROR	Fits Right Hand	\$59 ⁹⁹	EA ★



29" JUNIOR CATCHER'S MITT

- Full grain leather
- Pre-oiled for easy break in
- Deep pocket and scoop toe design
- Ideal for ages 5-8.

BBCMLLXX	Fits Left Hand	\$49 ⁹⁹	EA ★
BBCMLLFR	Fits Right Hand	\$49 ⁹⁹	EA ★

NJ State Approved Co-op #65MCECCPS - Metuchen/Garden State Apparel Bid Term: 5/9/18 - 5/8/20 - Extended to 5/8/21

Wilson GLOVES



A360 CATCHER'S MITT - 32.5"

- Lightweight, flexible and durable
- 1/2 Moon Web
- Youth pattern design

WLWTA03RB17CM325 Fits Left Hand **\$44⁹⁹** EA



A360 SP GLOVE - 14"

- Pro stock leather
- Rugged durability and unmatched feel
- Closed weave web

WLWTA03RS1714 Fits Left Hand **\$54⁹⁹** EA
WLWTA03LS1714 Fits Right Hand **\$54⁹⁹** EA



A360 SOFTBALL GLOVE - 13"

- Pro stock leather
- Great durability
- Closed mesh with V-lace web

WLWTA03RS1713 Fits Left Hand **\$49⁹⁹** EA

TRAINING GLOVES



MacGregor
INFIELD TRAINING GLOVE

- "Pancake" style glove is ideal for infield training
- Aids in developing a quick "glove to throw" transition
- Leather construction

1281491 Fits on left hand **\$31⁹⁹** EA ★



Mizuno GLOVES



MVP PRIME CATCHER'S MITT - 34"

- Center pocket designed pattern
- Padded thumb slot
- Professional level lace

MZ312445 RHT Only **\$114⁹⁹** EA



GXC75 CATCHERS MITT - 34"

- Professional pattern
- Two-piece closed web
- Closed back
- Pro-scoop technology

MZ311452 RHT Only **\$84⁹⁹** EA

ALSTAR GLOVES



PRO-ELITE CM3000

- Fast break-in and extended life
- Soft leather pocket allows for great feel
- Leather backing is stiffer to provide right amount of support

1396109 Fits Left Hand - 35" **\$379⁹⁹** EA
1396110 Fits Left Hand - 33.5" **\$379⁹⁹** EA
1396111 Fits Left Hand - 32" **\$379⁹⁹** EA



SOFTHANDS INFIELD TRAINER

- Durable foam infield training tool for developing quick hands while fielding ground balls or completing a double play.
- Officially approved and licensed by Little League® Baseball.

1255821 Professional Model **\$25⁹⁹** EA



SLIDE RITE

- The only training aid you need to teach perfect sliding techniques
- The patented design features a durable cordura cushioned mat and canvas sliding sheet to help take the fear out of sliding.

1037029 Standard Size (42"W X 12'L) \$354.99 EA



PRO MODEL

- Advanced tool lets coaches place grounders, flyballs, and line drives with pinpoint accuracy
- Made of graphite composites as professional rackets
- Treated torsion bands propel baseballs or softballs with speed and accuracy
- Perimeter weighted design
- Non-slip grip

BBACCBAT 26oz Pro Model \$89.99 EA

BASEBALL/SOFTBALL



STRIKER II HITTING TRAINER

- The perfect warm up/training device for baseball or softball.
- Comes with a 9" safety baseball that won't harm aluminum bats
- Designed to quickly attach to any chain link fence
- Fits easily into a player's bag.

STRIKER2 Complete Unit \$87.99 EA

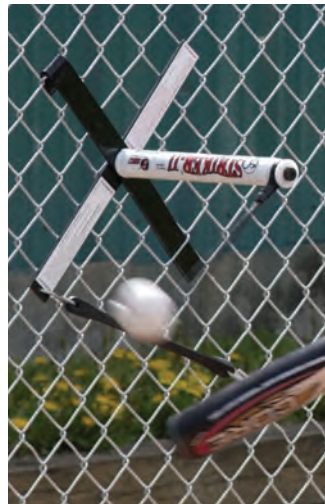

STRIKE ZONE

- Heavy duty design clamps to posts 2-1/2" to 4"D
- Creates great warm-up/hitting station.

1274183	Baseball	\$169.99 EA
1274190	Softball	\$169.99 EA
1274806	Extra ball/ropel(Specify Baseball or Softball)	\$38.99 EA

*SPECIFY BASEBALL OR SOFTBALL



HIT-A-WAY®

- Simulates pitches without chasing balls
- Develops hand-eye coordination and learning to switch hit
- New sleeve design improves visibility as well as contact feel & sound
- Post not included

5HITAWAYBB	Baseball	\$39.99 EA
5HITAWAYSB	Softball	\$39.99 EA



TRAINING BAT

- Excellent training bat for either one or two handed hitting drills
- Helps strengthen hands, wrist and forearms

1385179	28"	\$39.99 EA
1385180	22"	\$39.99 EA
1385181	18"	\$39.99 EA



EASTON TRAINING STICK

- The most effective & versatile batting drill device available
- Unique design features **BOTH Baseball & Softball ends**
- 63" length ideal for both Adult & Youth players
- Flexible shaft, texturized vibration dampening handle
- Dramatically

1264050 \$49.99 EA



EASTON THUNDERSTICK T10/T11

- Ideal for soft toss drills
- Can be used with plastic or regular baseballs
- Use plastic golf ball to sharpen hand-eye coordination
- 1" barrel

1264012 Youth T11 (30"/26oz) \$59.99 EA

PITCHER'S TRAINING AIDS



COLLEGIATE REBOUNDER SCREEN

- Large 7' x 7' frame
- Heavy-duty 1 1/2" square, 17 gauge galvanized steel tube construction
- 2.5mm twisted knotted PE, 1.75" mesh
- Rebounder has 4 angle adjustments - 0, 10, 20 and 30 degrees - and can direct ball up into the air or onto the ground
- Can be used from either side

1378661 \$299⁹⁹ EA ★



PITCHING TARGET

- Vinyl coated nylon catcher with pouch
- Two sided pitcher's target
- Will accommodate both right-handed and left-handed hitters
- Frame is 1-5/8" diameter, 18 gauge galvanized steel
- No tools required to assemble

1196849 Size - 48"W x 78"H. 30 lbs. \$244⁹⁹ EA ★



THE DESIGNATED HITTER

- Learn to pitch inside and how to handle hitters who crowd the plate
- Two-piece for safe and easy portability.
- Available in jersey colors: Red, Blue and Gray.
- Pro model batter stands 5'9" tall.
- Youth model batter stands 5'2" tall.

1. 1323498 Youth Model \$339⁹⁹ EA



STRIKE ZONE HOME PLATE

- Great for visual focus when teaching the importance of situational pitching and hitting
- Also great for umpire training
- For use by baseball and softball players of all ages and ability
- Extended version teaches pitchers to throw to the black

1. 1194081 Extended Version \$38⁹⁹ EA



THE ULTIMATE PITCHER'S & CATCHER'S PLATE™

- The plate highlights 3.5" on and 3.5" off the plate
- Provides a great visual for pitchers and catchers
- Can be used in hitting drills (two-strike hitting, expanding the zone)
- Made of lightweight yet very durable ABS

1. 1236552 \$67⁹⁹ EA



TRAVEL SCREEN

- Nylon netting with fiberglass pole frame
- Steel base
- Sets up in less than 2 minutes
- Fits in 30" travel bag

1385408 7' Screen \$199⁹⁹ EA



SOFT TOSS SCREEN

- Features a rigged steel and fiberglass pole patented design
- Assembles in minutes
- Zero maintenance
- Free carry case included

1347203 \$139⁹⁹ EA



ENDURO SOFT TOSS SCREEN

- Tubular steel frame
- Slip over "pillow case" design netting
- Over-hang on top for extra protection

K35762 Size - 6' x 4' \$299⁹⁹ EA



BIG MOUTH BMX SCREEN

- Newest version of the original Big Mouth Screen
- Great for all ages, from t-ball to college

1397413 \$149⁹⁹ EA



INSTANT SCREEN

- Made of sturdy lightweight spring steel
- Folds down to a compact 36" circle
- Weighs less than 10 lbs

1159943 Size - 7'H x 8'W \$184⁹⁹ EA



BASEBALL/SOFTBALL SCOREBOOK

- Ideal for baseball or softball with spiral at the top
- Each book scores 26 games with 16 batting positions and 9 innings per sheet
- Also includes team roster, season schedule, season totals, batting average chart, pitcher stats and simplified scoring instructions
- Pages measure 9-1/2" x 11"

MSBASBOK Standard Size \$5.49 EA

BASEBALL/SOFTBALL SCOREBOOK OVERSIZED

- Oversize pages (14" x 11") pages for easier scoring
- 30 game scorebook with 11 batting positions
- Also includes team roster, season schedule, season totals, batting average chart, pitch count, and simplified scoring instructions.

MCBIGBOK \$8.99 EA

BASEBALL/SOFTBALL LINE-UP CARD BOOKLET

- Four-part carbonless line-up cards
- 24 sets per booklet.
- 4 1/2" x 8 1/2"

MCLINEUP \$8.99 EA

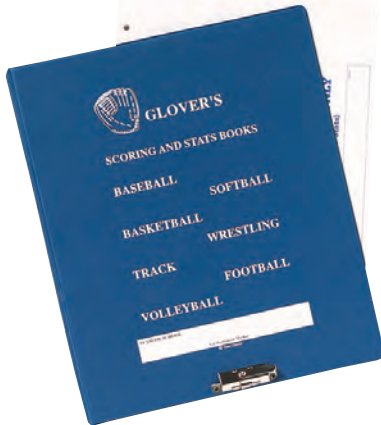

GLOVER'S BASEBALL/SOFTBALL SCORING & STAT REFILLS

- Includes simplified scoring instructions, batting average chart, 6-7-9 inning ERA chart, team summary pages, individual batting and pitching charts, and inning extenders.
- Sheets are 11" x 14.5"

MSGSCST pack of 30 \$19.99 PACK

GLOVER'S BINDER

- Keep 24, 48, or 72 games in one binder
- Clip keeps scoresheets firmly in place
- Multiple pockets for schedules, addresses, player rosters, etc
- Scoresheets not included.

MSGBIND \$29.99 EA

GLOVER'S BASEBALL/SOFTBALL SCORE SHEETS

- Includes inning extenders
- Packaged for coaches who have a computer and do not need individual stat sheets
- 11 batting positions

MSGLSOR pack of 50 \$24.99 PACK



DOUBLE SIDED COACH'S BOARD

- 15 1/2"H x 9 1/2"W dry-erase board with diagrams
- Includes dry-erase pen with eraser head and built in storage pocket

1235999 Board w/pen \$19.99 EA ★



PETERSON® SCOREMASTER

- Simplified scoring instructions
- Wire binding
- Club size 12" x 8-1/2"
- Enables complete summary of individual batting records and pitching performance
- Suitable for softball as well as baseball
- Contains 25 games with 11 batting positions.

MSPTBOK \$9.99 EA



HOME & ROAD PITCH COUNTER

- Dual pitch counter allows coaches to track two pitchers at once
- Sleek design fits ergonomically in hand

1264067 Color: Black only \$17.99 EA



TALLY COUNTER

- Hand held model
- Counts up to 9999

MSHTALLY \$9.99 EA ★



PERMANENT BAT RACK

- Heavy-duty galvanized steel bat rack
- Holds up to 14 bats
- Permanently mounts directly to dugout surface
- Weight: 33 lbs.

1148826 Size - 35"H x 25.5"W x 6"D \$177⁹⁹ EA ★

NEW!

FOUL BALL RETURN STATION

- Return foul balls to play without interrupting the game
- Easy to install
- Made of double powder coated hardened aluminum
- Works for both baseballs and softballs

1399574 \$69⁹⁹ EA

BASEBALL/SOFTBALL



SURFACE MOUNTED HELMET TREE

- Easy way to store batters helmets in the dugout
- Holds 12 helmets

BSHTS Size - 18"W x 12"D x 70"T \$239⁹⁹ EA ★



MacGregor HELMET CADDY

- Heavy-duty 600 denier polyester
- Oversized pockets
- Hangs on chain link fence or dugout
- Rolls up for easy storage and handling
- Black only

1187038 8 Helmet Model \$42⁹⁹ EA ★
1264029 12 Helmet Model (pictured) \$52⁹⁹ EA ★

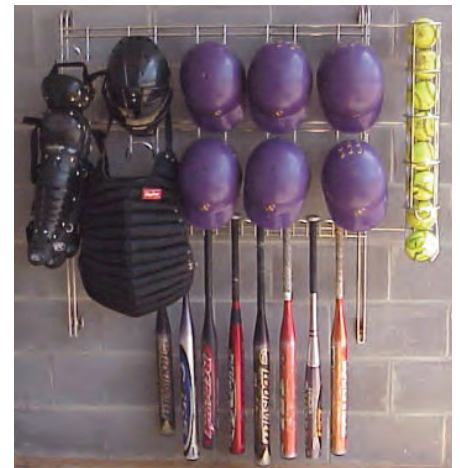

DUGOUT ORGANIZER RACK

- Durable steel rack that is easily attached to cement, brick or wood dugout walls.
- Holds up to 10 batting helmets with face guards, 12 bats and includes a ball chute for 10 baseballs or 8 softballs
- Dimensions: 39"H x 48-1/4"W

1046267 Baseball Version \$239⁹⁹ EA 
1046274 Softball Version \$239⁹⁹ EA 



FENCE BAT RACK

- Hooks on fence to hold 10 bats
- Steel construction
- Weight 5 lbs.

1159622 Size - 30" long \$62⁹⁹ EA ★



EXPANDO HELMET RACK

- Lightweight aluminum construction
- Clips on the dugout fence
- Holds 8 batting helmets.
- When not in use, it scissor folds to fit neatly into your bag

1148954 \$89⁹⁹ EA



BATTYSHACK DUGOUT ORGANIZER

- Holds 5 softballs or 6 baseballs and up to 12 bats
- Mounted batting order chart made of dry erase material (markers not included)
- Easily mounts on any surface
- Heavy duty plastic construction

1148954 \$89⁹⁹ EA



MLB® EVOLUTION T

- 100% polyester short sleeve jersey crewneck synthetic tee
- Developed with super lightweight polyester for breathability and moisture management
- Screenprinted team logo or wordmark

MJGY23
MJG223

Youth S-L
Adult S-2XL

\$18.99 EA
\$19.99 EA

EVERY TEAM IN STOCK



EVERY TEAM IN STOCK!



MLB CREW REPLICA JERSEY

- 100% cotton crew neck jersey
- Official, screened team name and logo
- Full athletic chest cut
- Straight hemmed bottom
- In-Stock for quick delivery

MLBRY
MLBRA
MLBRAXXL

Youth S-L
Adult S-XL
Adult XXL

\$11.99 EA
\$12.99 EA
\$13.99 EA



EVERY TEAM IN STOCK!



BASEBALL/SOFTBALL

MLB® EAGLE 2-BUTTON COLORBLOCK JERSEY

- 100% polyester short sleeve 2-button placket jersey
- Closed hole mesh with moisture wicking
- Contrast fabric color blocking. Curved bottom hem
- Screenprinted team logo or wordmark

MJIY83	Youth S-L	\$21 ⁹⁹ EA
MJI383	Adult S-2XL	\$23 ⁹⁹ EA





MINOR LEAGUE REPLICA T-SHIRTS

- 100% cotton jersey knit
- Screen printed with Authentic Team font or logo
- In-stock for quick delivery
- Jersey numbering available

MINY	Youth S-L	\$11.99 EA
MINA	Adult S-XL	\$12.99 EA



MINOR LEAGUE REPLICA CAPS

- Authentic Minor League Replica logos
- 6 panel, mid-profile, cotton twill
- Pre-curved visor
- Adjustable tab back

MINCAPY	Youth (6-5/8 to 7-1/4)	\$8.99 EA
MINCAPA	Adult (6-7/8 to 7-1/2)	\$8.99 EA





MAJOR LEAGUE® REPLICA VISORS BY OUTDOOR CAP®

- Cotton twill construction
- Adjustable tab back
- One size fits all

MLBV \$8.99 EA



MAJOR LEAGUE® REPLICA CAPS BY OUTDOOR CAP®

- Features 3D logo, cotton twill construction, & adjustable tab back

MLB300Y Youth: (6 5/8-7 1/4) \$8.99 EA
MLB300A Adult: (6-7 7/8-7 1/2) \$8.99 EA



MAJOR LEAGUE® REPLICA CAPS BY OUTDOOR CAP®

- 100% polyester mesh, moisture wicking, flat visor(easily shaped), Hook/Loop closure back

MLB400Y Youth: (6 5/8-7 1/4) \$11.99 EA
MLB400A Adult: (6-7 7/8-7 1/2) \$11.99 EA



BASEBALL/SOFTBALL



SET-IN REAR POCKETS



ELASTIC WAIST BASEBALL PANT

- 100% polyester with tapered legs
- Closed front with full 2-1/4" elastic waist band with hidden draw cord
- Set-in back pocket(1)
- Double knee construction

AALLBDK2	Youth XXS-XL	\$6 ⁹⁹ EA
AA604PDK2	Adult S-XXL	\$11 ⁹⁹ EA



BELTED WAIST BASEBALL PANT

- 100% polyester double knit, double knee
- 2-1/2" non-roll elastic waistband with two snap closures
- Pro-style tunnel pant loops
- Zipper front and back pocket
- Youth Sizes: S(20-22) M(24-26) L(28-30) XL(32-34)
- Adult Sizes: S(28-30) M(31-33) L(34-36) XL(38-40) XXL(42-44)

AA605PY	Youth S-XL	\$10 ⁹⁹ EA
AA605P	Adult S-3XL	\$13 ⁹⁹ EA



OPEN BOTTOM BASEBALL PANT WITH PIPING

- 100% double-knit 12oz polyester
- Relaxed fit, wide leg, open bottom pant
- 3/16" piping down both sides of pants
- Double-knee, set-in back pockets with Pro-Style belt loops
- 2.5" elastic waistband, hemmed leg bottoms
- Youth inseams: XS(23.5"), S(24"), M(25.5"), L(27"), XL(28.5")
- Adult inseams: S(31"), M(32"), L(33"), XL(34"), XXL(35")

AA605WLB	Youth S-XL	\$17 ⁹⁹ EA
AA605WLB	Adult S-3XL	\$21 ⁹⁹ EA



BASEBALL KNICKER PANT

- 100% durable knit 12oz polyester
- Traditional knicker length pant with covered elastic bottoms ending just below knees
- Five pro style belts loops
- Two double welted set-in back pockets
- 2.5" elastic waistband

AA605PKNY	Youth XS-LG	\$12 ⁹⁹ EA
AA605PKN	Adult S-2XL	\$13 ⁹⁹ EA



7" STIRRUPS

- 7" nylon stirrup
- Double-welt top, durable construction
- Ideal for baseball/softball

1397110	Solid Style-Specify Color	\$7 ⁹⁹ PR
1397126	Pattern Style-Specify Color	\$8 ⁹⁹ PR



BASEBALL-SOFTBALL BELTS

- Elastic baseball belt with matching leather tabs
- Nickel plated buckle; 1-1/2" width belt
- Adjustable belt fits waist sizes 22"-46"

1172577	\$5 ⁹⁹ EA ★
---------	------------------------



ALL-SPORT ONE COLOR SOCKS

- All Purpose Sock. 85% Acrylic, 10% Nylon, 5% Lycra Spandex.
- Colors: Black, Cardinal, Dark Green, Gold, Kelly, Maroon, Navy, Orange, Purple, Royal, Scarlet, White.

C20J	Junior (SM)	\$39 ⁹⁹ DZN
C20Y	Youth (MD)	\$40 ⁹⁹ DZN
C20V	Varsity (LG)	\$41 ⁹⁹ DZN

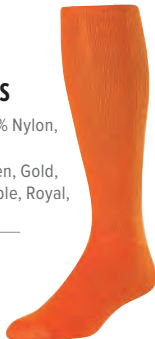

ONE COLOR BASEBALL SOCKS

- Heel and toe style
- 81% acrylic/18% nylon/1% spandex
- Colors: Black, Dk Green, Navy, Royal, Scarlet

C17T	Junior (SM)	\$43 ⁹⁹ DZN
C17Y	Youth (MD)	\$44 ⁹⁹ DZN
C17V	Varsity (LG)	\$45 ⁹⁹ DZN



Sizes	Junior	Youth	Varsity
Shoe Size	6-7	8-11	12-13
	1-5	5-9	9-13



MOCK MESH JERSEY

- 100% eXtreme mock mesh Cationic polyester with moisture management fibers
- 2-button henley with raglan shoulder shoulders and contrasting color
- Straight hemmed bottom
- Colors: Charcoal/Electric Yellow, Charcoal/Black, Charcoal/Dk Green, Charcoal/Maroon, Charcoal/Navy, Charcoal/Purple, Charcoal/Royal, Charcoal/Scarlet, Charcoal/White

AA525Y	Youth S-XL	\$16 ⁹⁹ EA
AA525	Adult S-3XL	\$18 ⁹⁹ EA



BASEBALL JERSEY

- 100% eXtreme microfiber Cationic polyester with moisture management fibers
- Raglan short sleeve t-shirt, front and back, self-material, contrast color side and underarm inserts
- Straight hemmed bottom and sleeves

AA506C1Y	Youth XXS-XL	\$13 ⁹⁹ EA
AA506C1	Adult S-3XL	\$16 ⁹⁹ EA

BASEBALL/SOFTBALL

2-BUTTON MESH JERSEY

- Two-button henley with raglan shoulders and inset placket
- Two color three stripe braid on sleeve ends and front collar.
- Set-in collar ending at raglan sleeve seams and contrasting color back.

AA524PDY	Youth S-XL	\$19 ⁹⁹ EA
AA524PD	Adult S-3XL	\$24 ⁹⁹ EA



2-BUTTON JERSEY

- 100% Extreme dura light mesh Cationic Colorfast Polyester
- One row of self-material, contrast color piping sewn into and around collar
- Lightweight, soft hand small hole mesh with excellent durability and breathability

AA52MTHJY	Youth S-XL	\$15 ⁹⁹ EA
AA52MTHJ	Adult S-3XL	\$19 ⁹⁹ EA



WOMEN'S FASTPITCH JERSEY

- 100% eXtreme mock mesh polyester with moisture management fibers
- 2-button henley inset placket
- Set-in short sleeves, straight hemmed bottom

AA522MMWY	Girls XS-LG	\$11 ⁹⁹ EA
AA522MMW	Women's S-2XL	\$13 ⁹⁹ EA

WOMEN'S FASTPITCH PANT

- 100% double knit polyester 12 oz
- Low rise womens cut with mid-calf length
- 2" elastic waistband with drawcord for perfect fit
- Zipper fly with two snap closure
- Colors: Black, Grey, Navy, Royal, Scarlet, White

AA605PLWY	Girls S-L	\$14 ⁹⁹ EA
AA605PLW	Womens XS-2XL	\$16 ⁹⁹ EA



TWO BUTTON FASTPITCH JERSEY

100% Extreme Pin Dot Mesh Cationic Colorfast Polyester With Moisture Management Fibers. Two Button Henley With Raglan Shoulders.

AA522PDWG	Girls' S-L	\$16 ⁹⁹ EA
AA522PDW	Women's S-2XL	\$19 ⁹⁹ EA

WOMEN'S KNICKER FASTPITCH PANT

100% Polyester. Traditional knicker length pant with covered elastic bottoms ending just below knees. Low rise women's cut. Double knee construction. Six pro-style belt loops. Zipper fly, two snap closure.

AA605PKNG	Girls' S-XL	\$14 ⁹⁹ EA
AA605PKNW	Women's XS-2XL	\$16 ⁹⁹ EA





RICHARDSON



CLASSIC LOOK

SURGE

MINIMUM ORDER-12 CAPS

PERFORMANCE AND TRADITION

Surge combines the technology of an engineered performance fabric with the traditional look and feel of wool serge, making it the right choice for baseball purists.

- | | | | |
|-----------------|-----------|-----------|-----------------|
| Black SEC | Navy SEC | Royal SEC | Red SEC |
| Purple SC | White C | Orange C | Dark Green SC |
| Cardinal SC | Maroon SC | Gold C | Columbia Blue C |
| *Texas Orange C | Gray C | Kelly C | Vegas Gold C |
- S** - Stock **E** - Custom Express **C** - Custom

Fitted 6 5/8 - 8 or Adjustable SM (6 1/2 - 7 1/8) or M-L (7 - 7 3/4)

*Texas Orange not available in piping color option



PERFORMANCE MESH

DRYVE

TRUE PERFORMANCE MESH

The modern, athletic look of our new Dryve mesh fits perfectly with today's performance team apparel. Breathable moisture-wicking fabric combines with our advanced ProCrown shape to bring you the coolest cap on the field.

- | | | | |
|-----------------|-----------|-----------|-----------------|
| Black SEC | Navy SEC | Royal SEC | Red SEC |
| Purple SC | White C | Orange C | Dark Green SC |
| Cardinal SC | Maroon SC | Gold C | Columbia Blue C |
| *Texas Orange C | Gray C | Kelly C | Vegas Gold C |
- S** - Stock **E** - Custom Express **C** - Custom

Fitted 6 5/8 - 8 or Adjustable SM (6 1/2 - 7 1/8) or MD-LG (7 - 7 3/4)

*Texas Orange not available in piping color option



FLEX FIT

PULSE

PERFORMANCE FLEXFIT

The original PTS cap, and leader in performance fabric with FlexFit baseball cap construction, making it the right shape and fit for today's player.

- | | | | |
|-----------------|-----------|-----------|-----------------|
| Black SEC | Navy SEC | Royal SEC | Red SEC |
| Purple SC | White C | Orange C | Dark Green SC |
| Cardinal SC | Maroon SC | Gold C | Columbia Blue C |
| *Texas Orange C | Gray C | Kelly C | Vegas Gold C |
- S** - Stock **E** - Custom Express **C** - Custom

Flex Fit XSM (6 1/2 - 6 7/8) SM - MD (7 - 7 1/4) LG - XL (7 1/4 - 7 5/8)

*New Youth Size (6 3/8 - 6 5/8)

*Texas Orange not available in piping color option



SOLID CONTRASTING COMBINATION ALTERNATE



CAP (CROWN/VISOR) + BUTTON + EYELET

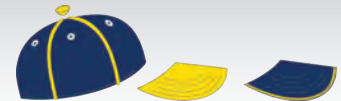

CROWN + BUTTON + EYELET + VISOR + PIPING

STOCK
1292923 \$18.99 EA
2 WEEKS FOR DELIVERY

CUSTOM EXPRESS
1292930 \$18.99 EA
2 WEEKS FOR DELIVERY

CUSTOM
1292947 \$20.99 EA
3-4 WEEKS FOR DELIVERY

ADDITIONAL EMBROIDERY

1292961 \$1.99 EA

RIGHT SIDE OR BACK



PIPING

1292954 \$2.25 EA



SANDWICH VISOR

1282399 \$1.00 EA

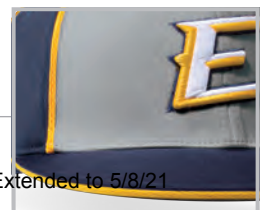

- A Gold
- Gold
- Optic White
- College White
- Orange
- H Red
- Scarlet
- Cardinal
- Maroon
- Walnut
- Purple
- Navy
- Light Navy
- Dark Royal
- Light Royal
- Sky Blue
- Dark Green
- Kelly Green
- Black
- Dark Graphite
- Gray
- Rust (Texas Orange)
- Vegas Gold



PERFORMANCE FABRIC CAP

CUSTOM TEAM CAPS

YOUR COLORS. YOUR DESIGN. NO SET-UP FEES!

1. CHOOSE CAP COLOR

- Over 18 team colors to choose from (8-10 weeks)
- Choose from 11 stock solid colors for 3-4 week delivery

2. CHOOSE A LOGO

- Is your design 1-3 letters?
- Is it a mascot or other design?
- Use our designs or yours

3. CHOOSE SIZES

- Fitted Custom 6 7/8 thru 8 1/2
- Fitted Stock 6 7/8 thru 8
- Adjustable (Perfect for boosters & parents...custom only)



- Original 5950 • Official cap of MLB • Original Fitted
- Custom caps in 8-10 weeks • Stock caps in 3-4 weeks

 BACK & RIGHT EMBROIDERY 1217209 \$2 ⁹⁹ EA	 PIPING FOR CUSTOM CAPS 1217339 \$1 ⁰⁹ EA
---	--

\$21⁹⁹

MINIMUM ORDER-24 CAPS

CUSTOM 5950 WITH EMBROIDERY

NE59PERL Performance \$21⁹⁹ EA

BASEBALL/SOFTBALL

CHOOSE A STOCK COLOR FOR FASTER DELIVERY!

STOCK 5950S ARE CLASSIC WOOL CAPS AVAILABLE IN 9 SOLID COLORS.



- | | | | | |
|--|---|--|---|--|
| Maroon | Purple | Light Royal | Gray | Black |
| Scarlet | Cardinal | Dark Green | Navy | |

STOCK CAP PRICING

1217193 With Logos \$19⁹⁹ EA

- All stock caps are High Crown
- Available in sizes 6 7/8 thru 8

PUT YOUR LOGO ON A STOCK CAP...IT SHIPS IN 3-4 WEEKS!

MINIMUM ORDER-24 CAPS



SEMESTER

- 39THIRTY, unfit sweatband
- Cotton twill visor and front
- White spacer mesh mid & rear panels
- Sizes: S/M, M/L

Color Options: **Black, Cardinal, Dark Royal, Maroon, Navy, Pink, Purple, Royal, Rust Orange, Scarlet, Sky Blue, White.**



3930 NEO

- 39THIRTY, unfit sweatband
- Cotton twill visor and front
- Colored spacer mesh mid & rear panels
- Sizes: S/M, M/L

Color Options: **Black, Cardinal, Dark Green, Kelly Green, Maroon, Navy, Royal, Rust Orange, Scarlet, White.**



3930 STRETCH POLY

- Low profile cap style
- 97% wool/3% spandex
- Closed back, unfit sweatband
- Sizes: S/M, M/L

Color Options: **Black, Cardinal, Dark Green, Grey, Kelly, Lt Navy, Maroon, Navy, Purple, Royal, Scarlet, Sky Blue.**

BEST SELLER



SPALDING
TF-1000 CLASSIC ZK



- Exclusive ZK™ microfiber composite
- Wide channel design
- Indoor use only

1336016	Official Size (29.5")	\$54.99 EA
1336023	Intermediate Size (28.5")	\$54.99 EA



SPALDING
TF-1000 LEGACY



- Exclusive ZK™ composite construction
- Optimized deep channel design
- Indoor use only

1335552	Official Size (29.5")	\$64.99 EA
1335569	Intermediate Size (28.5")	\$64.99 EA



NEW!

SPALDING
TF-1000 PLATINUM ZK

- Cutting-Edge ZK™ microfiber composite leather
- Unique symmetrical panel design
- Cushioned carcass and deep channel design
- Indoor use only
- NFHS approved

1398283	Official Size (29.5")	\$64.99 EA
1398284	Intermediate Size (28.5")	\$64.99 EA



SPALDING
TF PREMIER

- Top quality composite cover
- Wide channel design
- Indoor/Outdoor use

1376603	Official Size (29.5")	\$26.99 EA
1376604	Intermediate Size (28.5")	\$26.99 EA
1376605	Junior Size (27.5")	\$25.99 EA



SPALDING
TF-500

- Composite leather construction
- Soft feel and great grip
- Indoor/Outdoor use

LBTf500M	Official Size (29.5")	\$32.99 EA
LBTf500W	Intermediate Size (28.5")	\$32.99 EA



Wilson
JET COMPETITION

- High-performance composite leather
- Pebbled composite channels
- Cushion core technology
- Indoor use only

1366521	Official Size (29.5")	\$47.99 EA
1366528	Intermediate Size (28.5")	\$47.99 EA

BEST SELLER



Wilson
EVOLUTION



- HD pebbled microfiber composite construction
- Wide channel design
- Cushion core technology for softer feel
- Indoor use only

3 Year Limited Warranty

1013900	Official Size (29.5")	\$59.99 EA
1013917	Intermediate Size (28.5")	\$59.99 EA



Wilson
NCAA OFFICIAL GAME BALL



- Advanced composite cover absorbs perspiration and provides enhanced feel
- Aqua-grip channel design enhances grip
- Indoor use only

3 Year Limited Warranty

180701R	Intermediate Size (28.5")	\$69.99 EA
----------------	---------------------------	------------



Wilson
WAVE



- Moisture absorbing composite construction
- Pebbled composite channels
- Cushion core technology™
- Indoor use only

1235252	Official Size (29.5")	\$69.99 EA
1235258	Intermediate Size (28.5")	\$69.99 EA

Bid #ESCNJ 17/18-31

Educational Services Commission of New Jersey

Athletic Equipment & Supplies

BASKETBALL

BEST SELLER



MacGregor

X100

- Microfiber composite construction
- Wide channel design
- Indoor use only

2 Year Limited Warranty

MCX100XH	Official Size (29.5")	\$30⁹⁹ EA ★
MCX128XH	Intermediate Size (28.5")	\$30⁹⁹ EA ★

NFHS
APPROVED



MacGregor

X6000SL

- Synthetic construction
- Wide channel design
- Indoor/Outdoor use

1297140	Official Size (29.5")	\$19⁹⁹ EA ★
1297157	Intermediate Size (28.5")	\$19⁹⁹ EA ★



MacGregor

X6000

- Leather feel at half the price
- Durable composite construction
- Wide channel design
- Indoor/Outdoor use

2 Year Limited Warranty

MCX6000X	Official Size (29.5")	\$24⁹⁹ EA ★
MCX6285X	Intermediate Size (28.5")	\$24⁹⁹ EA ★
MCX6275X	Junior Size (27.5")	\$24⁹⁹ EA ★



695 GRIPSKIN

- UA GRIPSKIN Composite
- Deep Channel design
- 100% Nylon windings for added strength
- Butyl bladder for maximum air retention
- Indoor use only

1393398	Official Size (29.5")	\$59⁹⁹ EA
1393399	Intermediate Size (28.5")	\$59⁹⁹ EA

NFHS
APPROVED



495

- UA exclusive gripskin microfiber composite
- Deep channel design
- Indoor/Outdoor use

1367616	Official Size (29.5")	\$29⁹⁹ EA
1367617	Intermediate Size (28.5")	\$29⁹⁹ EA



Wilson

NCAA COMPOSITE

- Dual tone composite construction
- Pebbled/rubber wide channel design
- Indoor/Outdoor use

1366479	Official Size (29.5")	\$29⁹⁹ EA
1366480	Intermediate Size (28.5")	\$29⁹⁹ EA



VERSA TACK

- High performance composite leather
- Super tacky grip and deep pebbling
- Indoor/Outdoor use

1366482	Official Size (29.5")	\$24⁹⁹ EA
1366483	Intermediate Size (28.5")	\$24⁹⁹ EA
1366484	Junior Size (27.5")	\$24⁹⁹ EA



NEW!



HYPER ELITE

- Concave channels create grooves for consistent ball control
- Debossed dimple design creates a better grip
- Micro perforations help wick sweat away for better ball control
- Innovative butyl bladder helps maintain shape retention

NVBB0573801070	Official Size (29.5")	\$60⁹⁹ EA
NKBB0608801060	Intermediate Size (28.5")	\$60⁹⁹ EA

THE ROCK®



THE ROCK® PINK RIBBON

- Same ball as the C2C composite game ball
- Includes Pink lettering and Pink Ribbon to recognize Cancer Awareness
- Double-ply Nylon wound bladder
- Deep Pebble channel design
- Indoor use only
- NFHS Approved



1394971	Official Size (29.5")	\$49 ⁹⁹ EA
1394972	Intermediate (28.5")	\$49 ⁹⁹ EA



THE ROCK® AUTOGRAPH BASKETBALL

- Top quality synthetic leather cover
- Great for awards and displays
- 6 White panels
- Official Size (29.5")

1394976	Official Size (29.5")	\$25 ⁹⁹ EA
----------------	-----------------------	-----------------------



THE ROCK® RUBBER - ORANGE

- Durable rubber cover
- Enhanced pebbling
- Wide channel design
- Indoor/Outdoor use

1394981	Official Size (29.5")	\$9 ⁹⁹ EA
1394982	Intermediate Size (28.5")	\$9 ⁹⁹ EA
1394983	Junior Size (27.5")	\$9 ⁹⁹ EA



THE ROCK® RUBBER - COLORS

- Durable rubber cover
 - Enhanced pebbling
 - Wide channel design
 - Indoor/Outdoor use
- Color Options: **Black/Gold, Navy/Gold, Navy/White, Red/White/Blue, Royal/Gold, Royal/White, Scarlet/Black, Orange White**



LD874MG4200	Official Size (29.5")	\$9 ⁹⁹ EA
--------------------	-----------------------	----------------------

THE ROCK®

BASKETBALL

C2C

GAME BASKETBALL

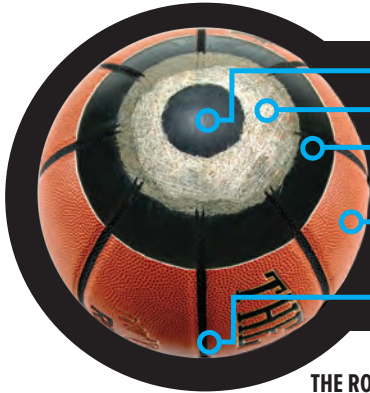

- Reinforced double ply Butyl Bladder -maximum air retention
- 100% Nylon wound -excellent shape retention and durability
- Exclusive patented sponge rubber carcass layer -extreme softness and handling improvement
- New Premium Grade Reinforced Composite material -SuperiorDurability. Scuff Resistant and NO Break-in Needed-Ready -Game Play!
- Unique Deep Pebble Channel design for best feel and grip



THE ROCK® C2C

- C2C Premium reinforced composite cover with sponge rubber carcass
- Double-ply Nylon wound bladder
- Deep Pebble channel design
- Indoor use only
- NFHS Approved

1394967	Official Size (29.5")	\$49.99 EA ★
1394968	Intermediate Size (28.5)	\$49.99 EA ★

CORE 2 COVER TECHNOLOGY



MG-4000-PC-NF

OFFICIAL SIZE, INDOOR USE ONLY
NFHS



McDONALDS® ALL-AMERICAN GAME BALL



THE ROCK.

MCDONALDS® ALL-AMERICAN 40TH ANNIVERSARY

- Special Edition 40th Anniversary basketball
- Official game ball of the McDonald's All American Games and Powerade Jam Fest
- Premium reinforced composite cover with sponge rubber carcass
- Double-ply Nylon wound bladder
- Deep Pebble channel design
- Indoor use only

1395091	Official Size (29.5")	\$42.99 EA
1395092	Intermediate Size (28.5")	\$42.99 EA



Voit RUBBER BASKETBALLS

ENDURO

- Durable rubber construction
- Recreational play
- Indoor/outdoor use



2 Year Limited Warranty

VCB2HXXX	Official Size (29.5")	\$11.49	EA ★
VCB8HXXX	Intermediate Size (28.5")	\$11.49	EA ★
VCB6HXXX	Junior Size (27.5")	\$11.49	EA ★
VCB5HXXX	Rookie Size (25.5")	\$11.49	EA ★



MacGregor RUBBER BASKETBALLS

RUBBER BASKETBALLS

- Durable rubber construction
- Wide channel design
- Indoor/Outdoor use



2 Year Limited Warranty

MCX35WID	Official Size (29.5")	\$9.99	EA ★
MCX500XX	Intermediate Size (28.5")	\$9.99	EA ★
MCX2500X	Junior Size (27.5")	\$9.99	EA ★



Voit XB 20 THE GRIP

- 2 ply cushioned cover provides superior feel
- Super tack finish for increased ball control
- Indoor/Outdoor use



VXB20HXX	Official Size (29.5")	\$15.99	EA ★
VXB20INT	Intermediate Size (28.5")	\$15.99	EA ★
VXB20JNR	Junior Size (27.5")	\$15.99	EA ★

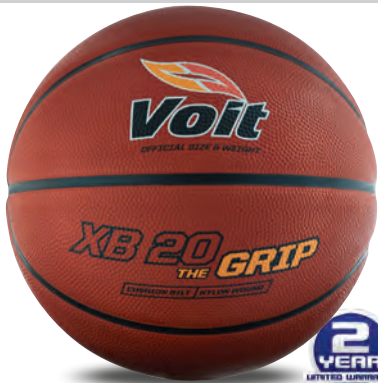

Voit

ENDURO CB2 REC DEPT. BASKETBALL

- Features "Property of Rec. Dept." logo
- Durable rubber construction
- Indoor/Outdoor use

VCB2HREC

Official Size (29.5")



\$10.99 EA ★



COMPOSITE BASKETBALL WITH YMCA LOGO

- Composite leather ball printed with the YMCA logo
- Wide channel with a tacky grip
- Indoor/Outdoor use

1384322	Official Size (29.5")	\$24.99	EA ★
1384323	Intermediate Size (28.5")	\$24.99	EA ★
1384324	Junior Size (27.5")	\$24.99	EA ★



MacGregor RUBBER BASKETBALL WITH YMCA LOGO

- Printed with YMCA logo
- Durable rubber construction
- Indoor/Outdoor use

1334098
1334104
1334111

Official Size (29.5")
Intermediate Size (28.5")
Junior Size (27.5")



\$9.99 EA ★
\$9.99 EA ★
\$9.99 EA ★



Bid #ESCNJ 17/18-31

Educational Services Commission of New Jersey

Athletic Equipment & Supplies

BASKETBALL



AUTOGRAPH BASKETBALL

- Laminated synthetic leather (PVC) cover
- For display purposes only
- 4 White panels
- Official Size (29.5)

1072501 Official Size (29.5") \$21⁹⁹ EA ★



SPALDING ROOKIE GEAR

- High performance composite construction
- Specifically engineered for kids ages 8 and under
- 27.5" - weighs 25% less than a standard ball
- Indoor/Outdoor use

1273281 Multi-Color \$26⁹⁹ EA
1273274 Brown \$26⁹⁹ EA



MacGregor RECRUIT

- High pebble rubber construction
- 22" circumference for younger players
- Indoor/Outdoor use

MCMINIBB Mini Size (22") \$9⁹⁹ EA ★



Voit LITE 80

- Rubber construction
- 20% lighter than a standard ball
- Indoor/Outdoor use

1291728 Intermediate Size (28.5") \$11⁴⁹ EA ★
1291735 Junior Size (27.5") \$11⁴⁹ EA ★

Voit LITE 80 PRISM PACK

- Set includes 1 each: Blue, Green, Orange, Purple, Red and Yellow
- Rubber construction
- 20% lighter than a standard ball
- Indoor/Outdoor use

1307030 Intermediate Size (28.5") \$64⁹⁹ SET OF 6 ★
1307047 Junior Size (27.5") \$64⁹⁹ SET OF 6 ★



MacGregor MULTICOLOR BASKETBALLS

- Durable rubber construction
- Deep channels and enhanced pebbling
- Indoor/Outdoor use

Color Options: Blue, Green, Orange, Purple, Red, Yellow.

936021 Official Size (29.5") \$12⁴⁹ EA ★
935021 Intermediate Size (28.5") \$12⁴⁹ EA ★
934021 Junior Size (27.5") \$12⁴⁹ EA ★



SPALDING TF-TRAINER 33" OVERSIZED

- Exclusive composite construction
- Improves shooting accuracy
- Indoor use only

1344110 \$55⁹⁹ EA



SPALDING TF-TRAINER WEIGHTED

- Weight: 3 lbs.
- Exclusive ZK composite construction
- Extends shooting range
- Improves arm, wrist and finger strength
- Indoor use only

1344103 Official Size (29.5") \$49⁹⁹ EA
1366481 Intermediate Size (28.5") \$49⁹⁹ EA



MacGregor BUILDER HEAVY BALL

- Heavy duty rubber construction
- Over 2 times heavier than a regulation ball
- Increase arm, wrist and finger strength
- Improves dribbling, passing and shooting
- Indoor/Outdoor use

MCKHVMM Official Size (29.5") \$38⁹⁹ EA ★
MCKHVWOM Inter Size (28.5"), 2.5 lbs. \$38⁹⁹ EA ★

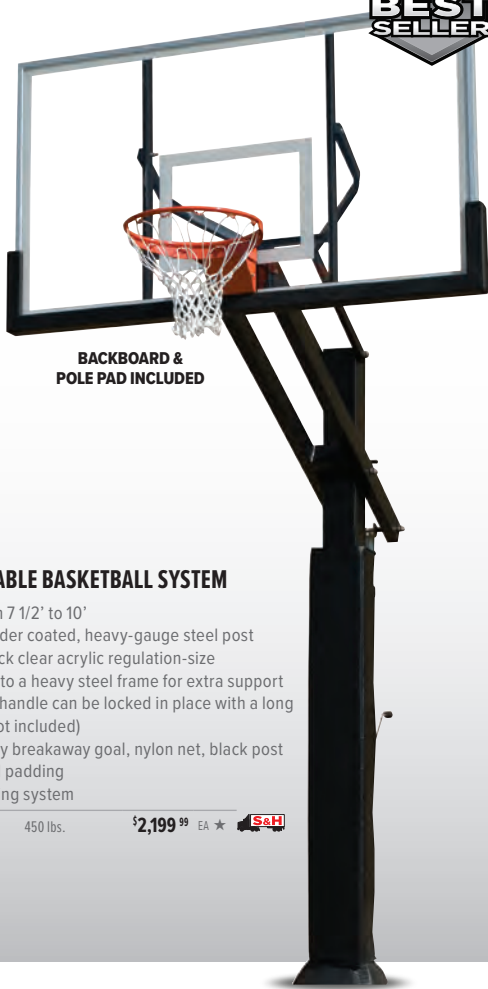

BACKBOARD & POLE PAD INCLUDED



GRIZZLY ADJUSTABLE BASKETBALL SYSTEM

- Height adjusts from 7 1/2' to 10'
- 6" x 6" square powder coated, heavy-gauge steel post
- 42" x 72" x 3/8" thick clear acrylic regulation-size backboard welded to a heavy steel frame for extra support
- Height adjustment handle can be locked in place with a long shackle padlock (not included)
- Includes heavy-duty breakaway goal, nylon net, black post pad and backboard padding
- Uses J-bolt anchoring system

1291247 450 lbs. **\$2,199⁹⁹** EA ★



ULTIMATE™ FIXED HEIGHT SYSTEM

- 6" x 6" square powder coated, heavy-gauge steel post
- 42" x 60", 12 gauge steel, white powder coated backboard with graffiti-resistant finish and safety rolled edges to eliminate sharp contact points
- 60" safe play area
- Includes 5/8" double ring, ultimate playground goal with exclusive no-fail netlock system and nylon net (post pad not included)

Lifetime Warranty

871444XX 500 lbs. **\$2,699⁹⁹** EA



ULTIMATE JR. SYSTEM

- 5" x 5" square powdered coated steel pole
- 5" x 5" square extension arm places backboard 36" away from pole
- Aluminum fan backboard w/breakaway goal - 35 1/2"H x 54"W
- Steel rectangular backboard w/flex goal - 42"H x 60"W

1388087 Fan Aluminum **\$1,899⁹⁹** EA
1388088 Rectangular Steel **\$1,999⁹⁹** EA



ULTIMATE™ ADJUSTABLE STEEL SYSTEM

- Same features as above "Ultimate" system but with 42" x 60" lifetime guarantee, graffiti-resistant, powder coated steel backboard



ULTIMATE™ OUTDOOR GLASS SYSTEM

- Same features as Ultimate system (871444XX) but with full size 42" x 72" competition glass backboard, heavy-duty flex goal, nylon net, post pad and backboard padding
- Lifetime guarantee on pole, five year limited guarantee on backboard, one year limited guarantee on goal and padding

Lifetime Warranty

987344XX 600 lbs. **\$4,399⁹⁹** EA

ULTIMATE™ POLE PADDING

- Protect players from injury caused by contact with pole
- 1" thick and 74" high vinyl covered foam

870444XX Black only **\$599⁹⁹** EA





OUTDOOR VERTICAL SYSTEM

- Built to withstand the use of your outdoor playground
- Available with 4' safe play area with either 4 1/2" or 3 1/2" O.D. vertical galvanized steel pole
- Cast aluminum fan-shaped backboard with continuous reinforcing ribs
- White powder coated 54" x 39" board with shooters target
- Includes durable economy goal with nylon net
- Goal mount centers 5" x 5"

PR50474	4' Extension w/Economy Rim - 4 1/2" Post	\$1,149 ⁹⁹ EA
PR50473	4' Extension w/Economy Rim - 3 1/2" Post	\$949 ⁹⁹ EA

OUTDOOR GOOSENECK SYSTEM

- These units are built to withstand the heavy duty use of your outdoor playground
- The goal, backboard and one-piece post bolt together forming a single solid unit
- Available with 4' or 5' safe play area with 4.5" O.D. galvanized steel gooseneck pole
- Cast fan-shaped aluminum backboard with continuous reinforcing ribs
- White powder coated 54" x 39" board with shooters target
- Choose from 3 rim options: Double rim with Chain Net, Standard rim with Nylon net or Breakaway Goal with Nylon Net
- Goal mount centers 5" x 5"

PR50059	5' Extension w/Double Rim & Chain Net	\$979 ⁹⁹ EA
PR50058	4' Extension w/Double Rim & Chain Net	\$959 ⁹⁹ EA
PR50055	5' Extension w/Standard Rim & Nylon Net	\$959 ⁹⁹ EA
PR50054	4' Extension w/Standard Rim & Nylon Net	\$939 ⁹⁹ EA
PR50057	5' Extension w/Breakaway Rim & Nylon Net	\$989 ⁹⁹ EA
PR50056	4' Extension w/Breakaway Rim & Nylon Net	\$969 ⁹⁹ EA



MEGA DUTY BASKETBALL UNITS

- 5 9/16" O.D. galvanized steel pole
- 72" safe play area
- Goal mounts directly through backboard to pole to virtually eliminate stress on backboard when hanging occurs
- Heavy 1 5/8" backboard braces
- 48" in-ground bury
- System includes ultimate double rim, nylon net, backboard, backboard braces and post

Lifetime Warranty

ALUMINUM FAN BACKBOARD

- Cast aluminum fan-shaped backboard with continuous reinforcing ribs
- White powder coated 54" x 39" board with shooters target
- Front mount Economy Goal with nylon net
- Standard 20" x 35" backboard mounting
- Universal goal mounting pattern
- Hardware included when purchasing board and goal together

Lifetime Warranty

1. 20020077	Steel Rectangular Backboard - 42" x 60"	\$2,699 ⁹⁹ EA	
2. 20020075	Aluminum Fan Backboard - 35" x 54"	\$2,099 ⁹⁹ EA	
3. 20020078	Polycarbonate Backboard - 42" x 54"	\$2,299 ⁹⁹ EA	

PR232202	Backboard w/Standard Rim and Nylon Net	\$579 ⁹⁹ EA
PR232201	Backboard Only	\$449 ⁹⁹ EA



SPALDING

FASTBREAK 960 PORTABLE BASKETBALL STANDARD

- Features goal height adjustment from 7' to 10'
- Extension arm provides 6' safe play area at 10' goal height
- Multi-piece base padding included (black)
- Folds easily by two people in minutes
- Includes 60" x 36", 3/8" thick high performance, aluminum framed acrylic backboard, Pro Image™ breakaway goal and nylon net
- Requires 300 lbs. of ballast (not included)

2 Year Limited Warranty

1048216 \$3,399⁹⁹ EA

FASTBREAK 940 PORTABLE BASKETBALL STANDARD

- Same features as 960 model but with a smaller 54" x 32" aluminum framed acrylic backboard

2 Year Limited Warranty

1048223 \$2,999⁹⁹ EA



MICRO-Z54 PORTABLE BASKETBALL STANDARD

- Highly portable system with 4' boom
- Rolls easily on four casters and locks in place with a brake lever
- Spring assisted height adjustment from 7' to 10'
- Black padded front base and riser
- Backboard padding not included
- Includes a 32" x 54" acrylic backboard and an official size breakaway goal with nylon net
- Requires 250 lbs. of ballast (not included)
- Not for main court use or dunking activities

2 Year Limited Warranty

1393447	Complete Unit	\$2,599 ⁹⁹ EA	
1393448	Replacement Backboard	\$649 ⁹⁹ EA	
1393449	Replacement Breakaway Goal	\$139 ⁹⁹ EA	

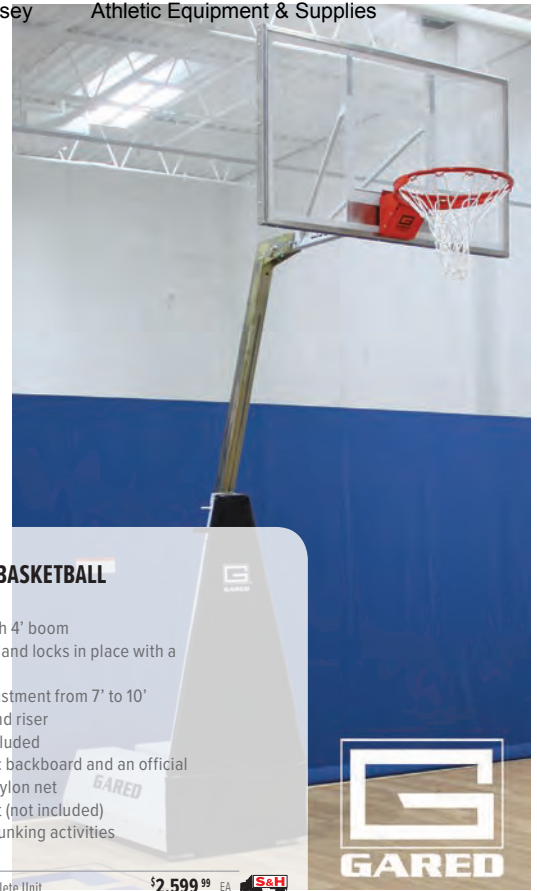

CLUB COURT PORTABLE BASKETBALL SYSTEMS

- 36" x 54" tempered glass backboard with break-a-way goal
- Spring assisted goal height adjustment from 6 1/2' to 10' with goal height indicator labels
- 1 1/2" thick, black padded front base and riser
- Oversized ballast box holds either 425 lbs. or 850 lbs. of ballast (not included)
- Goal mounts directly to extension arm, eliminating stress on backboard during play
- Folds without tools for transport on non-marking casters (fits through 78" high double doors)

2 Year Limited Warranty

1299373 Super Club Court \$3,499⁹⁹ EA

ACRYLIC CLUB COURT

- 32" x 48" acrylic backboard
- Flex goal
- 36" safe play area when goal is at 10'

NJ State Approved On #65MCECOPS Metuchen/Garden State Athletic Apparel Bid Term: 5/9/18 - 5/8/20. Extended to 5/8/21

833444XX \$2,499⁹⁹ EA



T-REX™ ADJUSTABLE/PORTABLE SYSTEMS

- Design makes one person setup and storage easy and fast
- Utilizes the same spring technology used in collegiate and professional arenas throughout the country
- Direct mount 42" x 72" glass backboard
- TruFlex Competition Breakaway Goal
- Adjustable from 5' to 10' (6" increments)
- Self-lubricating bronze bearings used in all pivot points
- Fully padded base (2" thick - covers 78" high)
- Duraskin™ backboard padding

20026189 T-Rex 96 System

\$8,499⁹⁹ EA

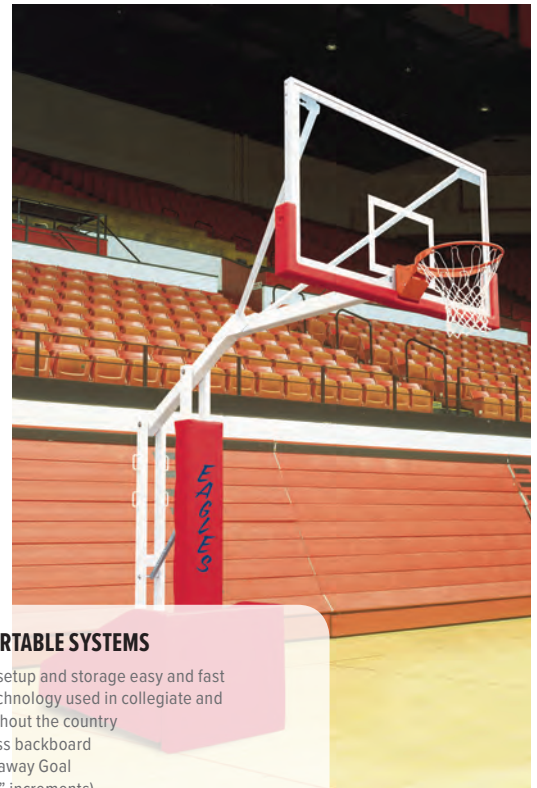

Bid #ESCJ 17/18-31

Educational Services Commission of New Jersey

Athletic Equipment & Supplies

BASKETBALL



GYMNASIUM™ HEIGHT ADJUSTMENT SYSTEMS

- Adjusts rim height from 10' to 8' and anywhere between using hand crank operated from the floor
- Easy-to-read height indicator labels
- Heavy duty 2" square silver powder coated steel structure moves backboard 4 1/4" closer to the free throw line
- Most fan boards have 20" x 35" mounting
- Most 42" x 72" boards have 36" x 62" mounting
- Most 48" x 72" boards have 42" x 62" mounting

5043XXXX	20" x 35" Fan Mounting	\$1,499 ⁹⁹ EA	
5042XXXX	36" x 62" Mounting	\$1,599 ⁹⁹ EA	
5044XXXX	42" x 62" Mounting	\$1,599 ⁹⁹ EA	



QWIKCHANGE™ SHOOTING STATION

- Entire system mounts easily to the wall with two load spreading struts
- No ladders or tools
- 7 1/2' to 10' goal height adjusts from the playing surface in 6" increments
- Mounts indoors/outdoors
- 22" safe play area at 10'
- Wall mounting hardware not included

2002050	1) Fan Shaped Graphite 36" x 48"	\$799 ⁹⁹ EA	
1187687	2) Rectangular Acrylic 32" x 48"	\$1,099 ⁹⁹ EA	

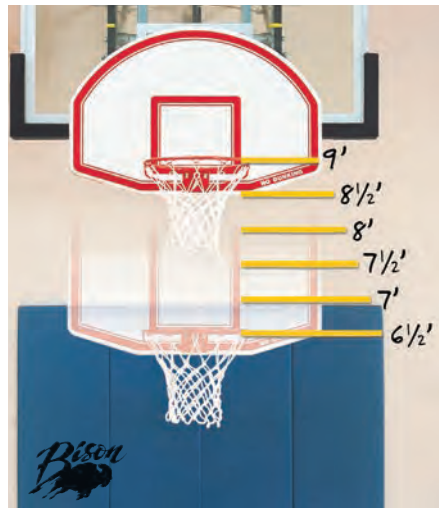

6-IN-1 EASY-UP™ YOUTH MINI GOAL

- Can be adjusted to 6 different heights (6 1/2' to 9')
- Lowers rim and moves rim 24" closer to free throw line; full sized rim
- Total system weight is less than 40 lbs.
- 32" x 48" backboard is molded of high impact ABS plastic
- Ships assembled and fits any style goal
- Not suitable for dunking or hanging from goal

1295825	\$799 ⁹⁹ EA
---------	------------------------



ZIP CRANK™ ADJUSTABLE SHOOTING STATION

- 36" x 54" x 1/2" thick acrylic backboard looks and plays much like higher priced glass systems
- Easy to operate, removable hand crank adjusts goal height from 7 1/2' to 10'
- Competition design breakaway goal and direct goal mount design makes backboard virtually unbreakable during normal play
- Steel structure mounts to wall by means of three load spreading struts
- Mounts indoors/outdoors and has 30" safe play area at 10'
- Wall mounting hardware not included

20020300	NJ State Approved, 6540E SC OPS Metuchen/Garden State Appar Bid Item: 5/9/18	\$1,699 ⁹⁹ EA	
----------	--	--------------------------	--



PLAYTIME™ BASKETBALL STANDARD

- Telescoping adjustment from 6'6" to 8' (6" increments)
- 34" white powder coated formed steel base
- Rubber rim protects the floor
- Goal, net, blue protective pad and hardware included
- Built-in 100 lb. ballast
- Indoor or outdoor use

1271676	Replacement Backboard	\$229 ⁹⁹ EA
---------	-----------------------	------------------------



QWIKCHANGE™ PLAYGROUND SYSTEM

- Height adjusts from 7 1/2' to 10' (6" increments) without unbolting the backboard
- Includes 72" high black pole safety padding, reflex rim and net
- 34" base weighs 340 lbs. for stability
- Heavy duty 3 1/2" galvanized steel pole
- Base has (2) 3" heavy-duty wheels for easy transport
- Outdoor use only

20028011	Rectangular Acrylic 32" x 48"	\$1,799 ⁹⁹ EA	
----------	-------------------------------	--------------------------	--

For outdoor use only



HIGH SCHOOL BACKBOARD PACKAGE

- 42" x 72" glass backboard
- TruFlex Breakaway rim
- DuraSkin padding

Lifetime Warranty

Color Options: **Black, Brown, Burnt Orange, Cardinal, Columbia Blue, Forest, Gold, Grey, Kelly, Maroon, Navy, Orange, Purple, Royal, Scarlet, Vegas Gold.**

1376347	Backboard, Goal and Padding	\$1,599 ⁹⁹ EA	
5028XXXX	42" x 72" Backboard Only	\$1,049 ⁹⁹ EA	
5027XXXX	48" x 72" Backboard Only	\$1,049 ⁹⁹ EA	

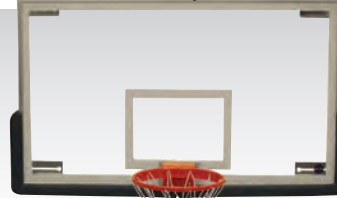

SPALDING SUPERGLASS™ COLLEGIATE PACKAGE

- Includes 1/2" tempered glass backboard, Slam Dunk goal with net and bolt-on backboard padding
- 42" x 72" glass backboard
- 36" x 63" mounting bracket spacing
- Meets all NCAA, NFHS and FIBA specifications

7 Year Limited Warranty

Color Options: **Black, Forest Green, Gold, Grey, Kelly, Maroon, Navy, Orange, Purple, Royal, Scarlet.**

1048292	Backboard, Goal and Padding	\$1,799 ⁹⁹ PACK
---------	-----------------------------	----------------------------

SUPERGLASS™ COLLEGIATE BACKBOARD ONLY

- 1/2" tempered glass with 2" border and target
- Unique mounting plate and hardware for even stress distribution
- Meets all FIBA, NCAA, and NFHS specifications
- Pre-drilled for padding (not included)
- 42" x 72" board has 5" x 4" goal mounting pattern
- 48" x 72" board has 5" x 5" goal mounting pattern

7 Year Limited Warranty

1048247	42" x 72"	\$1,299 ⁹⁹ EA
1048261	48" x 72"	\$1,399 ⁹⁹ EA



UNBREAKABLE™ SHORT GLASS BACKBOARD

- 42" x 72" with 1/2" thick tempered glass
- Built-in goal leveling device
- 35 1/2" x 62" mounting bracket spacing and 5" x 4" goal mounting pattern
- Pre-drilled for Duraskin™ padding
- Note: The glass itself is not unbreakable. Breakage in transit, during mounting, malicious acts, or deliberate attempts to damage are not covered under this guarantee.
- Color options: Black, Brown, Burnt Orange, Cardinal, Columbia Blue, Forest Green, Gold, Grey, Kelly Green, Maroon, Navy, Orange, Purple, Royal, Scarlet, Vegas Gold

Lifetime Warranty

5150XXXX	Backboard with Padding	\$1,449 ⁹⁹ EA	
5151XXXX	Backboard Only	\$1,199 ⁹⁹ EA	



REGULATION SIZE ACRYLIC BACKBOARD

- Heavy duty 3/8" thick acrylic backboard
- Heavy duty 1 1/2" wide steel frame
- Regulation size 42" x 72"
- Standard 36" x 62" backboard mounting pattern
- 5" x 5" goal mounting pattern

2 Year Limited Warranty

1245943	Backboard Only	\$999 ⁹⁹ EA
---------	----------------	------------------------



CONVERSION ACRYLIC BACKBOARD

- Heavy duty 3/8" thick acrylic backboard 1 1/2" wide steel frame
- For use when converting fan shaped backboard to regulation 42" x 72" rectangle board
- Standard 5" x 5" goal mounting pattern

1245936	Backboard Only	\$999 ⁹⁹ EA
---------	----------------	------------------------



UNBREAKABLE™ TALL GLASS BACKBOARD

- 48" x 72" with 1/2" thick tempered glass
- Built-in goal leveling device
- 42" x 62" mounting bracket spacing and 5" x 5" goal mounting pattern
- Pre-drilled for Duraskin™ padding (not included)
- Note: The glass itself is not unbreakable. Breakage in transit during mounting, malicious acts, or deliberate attempts to damage are not covered under this guarantee.

Lifetime Warranty

1302776	Backboard Only	\$1,199 ⁹⁹ EA
---------	----------------	--------------------------

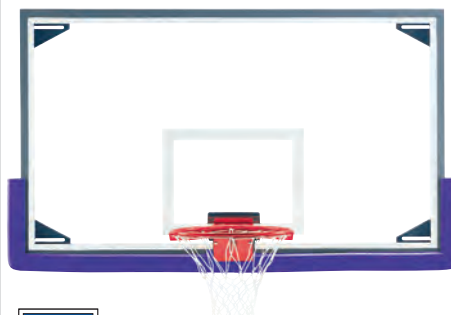

AFRG - ALUMINUM FRAME GLASS BOARD

- Heavy duty corner brackets and direct to goal mounting allows for disbursement of stress along the extruded frame
- 1/2" tempered glass with fired-in target and border
- 5" x 4" goal mounting pattern
- Meets NCAA, NAIA & NFHS specifications

Lifetime Warranty

1237429	48" x 72" Backboard Only	\$1,099 ⁹⁹ EA	
---------	--------------------------	--------------------------	--



UNBREAKABLE POLYCARBONATE BACKBOARD

- 42" x 54" with white shooter's square
- 1/2" thick polycarbonate material is virtually bullet-proof
- 27" x 34 3/4" mounting bracket spacing and 5" x 4" goal mounting pattern

Lifetime Warranty

5407XXXX	Backboard Only	\$1,849 ⁹⁹ EA
----------	----------------	--------------------------

Bid #ESCNJ 17/18-31

Educational Services Commission of New Jersey

Athletic Equipment & Supplies



PRO-STRUT CONVERSION BACKBOARD

- Official size 42" x 72" glass backboard is designed to mount at the same attachment points as a fan shaped backboard.
- Brushed aluminum extrusions secure 1/2" thick fully tempered glass to the unitized steel frame.
- 5" x 4 1/2" goal mount pattern (goal sold separately)
- Padding sold separately - see page 111

Lifetime Warranty

1383914 Backboard Only - 210 lbs. \$999⁹⁹ EA



ARG CONVERSION GLASS BACKBOARD

- 42" x 72" steel framed backboard only
- Replaces fan shaped or small glass backboards
- Designed for direct, three or four point mounting with steel mounting plates which strengthen backboard and prevent glass damage
- Frame pre-drilled for padding (not included)
- 5" x 4" goal mount pattern (goal sold separately)
- Meets NCAA and NFHS specifications

Lifetime Warranty

1237436 Backboard Only - 220 lbs. \$1,199⁹⁹ EA



CONVERSION GLASS BACKBOARDS

- Convert courts from fan-shaped to rectangular glass backboards
- Converts without a new mounting structure
- Ready to install with no drilling or relining of court
- Pre-drilled for DuraSkin® padding (not included)
- Mounting hardware included
- Goal sold separately

Lifetime Warranty

5155XXXX 42" x 72" - 223 lbs. \$1,149⁹⁹ EA
 5154XXXX 48" x 72" - 246 lbs. \$1,199⁹⁹ EA



FAN-SHAPED BACKBOARD

- 39" x 54" cushioned 1/2" tempered glass
- Heavy duty aluminum framework
- Shooter's square and border are fired into glass
- Standard 20" x 35" mounting brackets
- Color options: Black, Grey, Royal Blue, Scarlet

Lifetime Warranty

5152XXXX Board and Padding \$1,699⁹⁹ EA
 5153XXXX Board Only \$1,499⁹⁹ EA



STEEL REAR MOUNT BACKBOARD

- 35" x 54" backboard with 4" x 3 5/8" goal mounting pattern
- Standard 20" x 35" mounting
- Vibration-free unit stabilized by 12 gauge horizontal and 10 gauge vertical channels
- Phosphate treated and powder coated for maximum protection against weathering

1140118 Backboard with Goal and Net \$599⁹⁹ EA
 1140125 Backboard Only w/Target and Border \$559⁹⁹ EA
 1140132 Backboard Only - Solid White \$499⁹⁹ EA



STEEL FRONT MOUNT BACKBOARD

- 35" x 54" steel backboard with 5" x 4 1/2" goal mounting pattern
- Standard 20" x 35" mounting
- Phosphate treated and powder coated for maximum protection against weathering
- Goal sold separately

1140149 Includes Shooter's Square \$499⁹⁹ EA
 1140156 Solid White Backboard \$469⁹⁹ EA



ULTIMATE STEEL BACKBOARD

- 42" x 60" backboard
- Graffiti resistant finish
- 5" X 5" goal mounting pattern
- 20" X 35" mounting brackets
- Attaches to any current fan-shaped ceiling or wall mounted structure

10 Year Limited Warranty Approved Co-op #65MCECCPS Metuchen/Garden State Appre Bid Term: 5/9/18 - 5/8/20: Extended to 5/8/21
 5156XXXX Backboard Only \$999⁹⁹ EA



FRONT MOUNT BACKBOARD

- 35 1/2" x 54" cast aluminum backboard
- White powder coated finish with orange shooters square
- Heavy support ribs
- Goal sold separately

1376346 Backboard Only \$549⁹⁹ EA



BEST SELLER

NFHS APPROVED

MacGregor
GAME SERIES BREAKAWAY GOAL

- Competition level flex rim
- Tube-tie net attachment
- Powder coated finish
- Includes Anti-whip net and mounting hardware
- Meets NCAA and NFHS specifications
- Indoor/Outdoor use

PR236H00 \$149⁹⁹ EA



Bison

PROTECH™ BREAKAWAY GOAL

- Front mount, 5/8" solid steel, powder coated single rim
- Traditional ball and socket positive lock mechanism
- Continuous no-tie net attachment
- 4" x 5" and 5" x 5" goal mounting patterns
- Includes net and mounting hardware
- Meets NCAA and NFHS specifications
- Indoor use only

3 Year Limited Warranty

354444XX \$299⁹⁹ EA



SPALDING
SLAMMER COMPETITION 180° GOAL

- Front mount, 5/8" solid steel, powder coated single rim
- Adjustable tension 180° side and front flex action
- Easy-glide net attachment system
- Universal mounting pattern
- Includes net and mounting hardware
- Meets NFHS specifications
- Indoor use only

5 Year Limited Warranty

1008210		\$339 ⁹⁹ EA
1388019	#2 Net Cable	\$32 ⁹⁹ EA



MacGregor
FRONT MOUNT DOUBLE RIM FLEX GOAL

- Double 5/8" solid steel, powder coated rim
- Flex design with 15 degree deflection auto return
- Universal goal mounting pattern
- Includes net and mounting hardware
- Indoor/Outdoor use

Lifetime Warranty

PR238H00 \$189⁹⁹ EA



Bison

ELITE™ BREAKAWAY GOAL

- Front mount, 5/8" solid steel, powder coated single rim
- Low maintenance breakaway mechanism with padded cover-plate
- Six point lubrication system for smooth action (lubrication gun incl.)
- Continuous no-tie net attachment
- 4" x 5" and 5" x 5" goal mounting patterns
- Includes net and mounting hardware
- Meets NCAA and NFHS specifications
- Indoor use only

5 Year Limited Warranty

5111XXXX \$379⁹⁹ EA



SPALDING
SLAM DUNK PRO GOAL

- Front mount, 5/8" solid steel, powder coated single rim
- Top adjust positive lock release mechanism
- Easy glide #2 net attachment system
- Universal goal mounting pattern
- Includes net and mounting hardware
- Meets NBA, NCAA and NFHS specifications
- Indoor use only

7 Year Limited Warranty

1007923		\$359 ⁹⁹ EA
1388019	#2 Net Cable	\$32 ⁹⁹ EA



porter
ULTRA-FLEX II BREAKAWAY GOAL

- Front mount, 5/8" solid steel, powder coated single rim
- Designed to release with 180 lb. static load
- Tube-tie net attachment system
- 5" x 4-1/2" goal mounting pattern
- Includes anti-whip net and mounting hardware
- Indoor use only
- Meets NCAA Div 2 & 3 and NFHS specifications

3 Year Limited Warranty

1388578 \$239⁹⁹ EA



Bison

FRONT MOUNT FLEX GOAL

- Front mount, 5/8" solid steel, powder coated single rim
- Flex design with 15 deflection-auto return
- Continuous no-tie net attachment
- Universal goal mounting pattern
- Includes net and mounting hardware
- Indoor/Outdoor use

5132XXXX \$269⁹⁹ EA



Bison

REACTION ADJUSTABLE TENSION BREAKAWAY GOAL

- Front mount, 5/8" solid steel, powder coated single rim
- AcuFlex adjustable positive lock mechanism allows fine tuning of tension for ideal playing conditions
- Hideaway net attachment system
- 4" x 5" and 5" x 5" goal mounting patterns
- Includes net and mounting hardware
- Meets NCAA and NFHS specifications
- Indoor use only

4 Year Limited Warranty

354445XX \$419⁹⁹ EA



7550 - TITAN FRONT MOUNT PLAYGROUND GOAL

- Double rings (1/2" top ring & 3/4" bottom ring)
- Continuous no-tie net attachment
- 5" x 5" mounting pattern
- Includes net and mounting hardware
- Outdoor use

Lifetime Warranty

1237467 **\$189⁹⁹** EA



6600 REAR MOUNT BREAKAWAY GOAL

- Rear mount, 5/8" solid steel, powder coated single rim
- Continuous no-tie net attachment
- 4" x 3 7/8" goal mounting pattern
- Includes net and mounting hardware
- Indoor/Outdoor use

5545XXXX **\$239⁹⁹** EA



COLLEGIATE 2000 BREAKAWAY GOAL

- Front mount, 5/8" solid steel, powder coated single rim
- Adjustable positive lock mechanism allows precise fly-back action
- Continuous no-tie net attachment
- 4" x 5" goal mounting pattern
- Includes net and mounting hardware
- Meets NCAA, NFHS and NAIA specifications
- Indoor use only

4 Year Limited Warranty

5038XXXX **\$259⁹⁹** EA



MacGregor

FRONT MOUNT ECONOMY GOAL

- Front mount, 5/8" solid steel, powder coated single rim
- 5/8" reinforcing bars
- Continuous no-tie net attachment
- 5" x 5" Goal Centers
- Includes nylon net and mounting hardware
- Indoor/Outdoor use

PR00235000 **\$69⁹⁹** EA



5500 - DOUBLE RIM FRONT MOUNT BREAKAWAY GOAL

- Double 5/8" solid steel, powder coated rim
- Double spring flex breakaway mechanism
- No-tie net attachment
- 4 1/2" x 5" goal mounting pattern
- Includes net and mounting hardware
- Outdoor use

3 Year Limited Warranty

1237450 **\$249⁹⁹** EA



REAR MOUNT DOUBLE RIM GOAL

- Double 5/8" rings, solid steel, powder coated rim
- Continuous no-tie net attachment
- Universal goal mounting pattern
- Includes net and mounting hardware
- Outdoor use

20020031 **\$209⁹⁹** EA



SPALDING

ROUGHNECK GORILLA GOAL

- Front mount, 5/8" solid steel, powder coated single rim
- 5/8" reinforcing bars
- Continuous no-tie net attachment
- Universal mounting pattern
- Includes net and mounting hardware
- Indoor/Outdoor use

3213XXXX **\$159⁹⁹** EA



MacGregor

FRONT MOUNT SUPER GOAL

- 5/8" top ring, 1/2" bottom ring, powder coated, solid steel
- Two rim support braces for strength
- 5" x 5" goal centers
- Includes net and mounting hardware
- Indoor/Outdoor use

Lifetime Warranty

PR00202NET Chain Net **\$129⁹⁹** EA
PR00202H00 Nylon Net **\$99⁹⁹** EA



240 - DOUBLE RIM FRONT MOUNT SUPER GOAL

- Double rings (5/8" top ring, 1/2" bottom ring)
- Continuous no-tie net attachment
- 4" x 5" and 5" x 5" mounting patterns
- Includes net and mounting hardware
- Outdoor use

2 Year Limited Warranty

1237474 **\$129⁹⁹** EA



66T - REAR MOUNT INSTITUTIONAL GOAL

- Rear mount, 5/8" solid steel, powder coated single rim
- No-tie net attachment
- 4" x 3 7/8" mounting pattern
- Includes net and mounting hardware
- Outdoor use

20015034 **\$109⁹⁹** EA



1000 SCHOLASTIC BREAKAWAY GOAL

- Front mount, 5/8" solid steel, powder coated single rim
- Unique stack spring construction for true rebound
- Continuous no-tie net attachment
- 4" x 5" goal mounting pattern
- Includes net and mounting hardware
- Meets NCAA, NFHS and NAIA specifications
- Indoor use only

1237443 **\$219⁹⁹** EA



MacGregor

FRONT MOUNT PLAYGROUND GOAL

- Double 5/8" solid steel, powder coated rim
- Reinforced design for superior support
- Exclusive "no-fail" continuous net-lock system
- 5" x 5" goal centers
- Includes chain net and mounting hardware
- Outdoor use

Lifetime Warranty

PR00251H00 **\$149⁹⁹** EA

INDOOR NETS



BRUTE

• 288 gram, 12 loop, braided nylon

SNBBN288Y \$6⁹⁹ EA ★

HEAVY DUTY ANTI-WHIP

• 145 gram, 12 loop, braided nylon

SNBBNWIPIY \$5⁹⁹ EA ★

STANDARD DUTY

• 144 gram, 12 loop, braided nylon

SNBBN144Y \$4²⁹ EA ★

TRADITIONAL

• 90 gram, 12 loop, braided nylon

SNBBN90XY \$3²⁹ EA ★

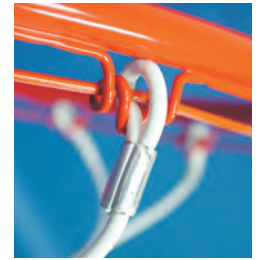

PERMANET HIGH ENDURANCE BASKETBALL NET

- 2000 lb. high-strength, flexible steel cable construction lasts up to 18 times longer than a standard basketball net
- Large loop design and protective vinyl coating help minimize hand injuries
- Rimlock theft-deterrent system permanently attaches net to rim
- Unique design resists sticking, tangling, fraying, shrinkage and rotting
- Rim not included

1079715

\$29⁹⁹ EA ★

OUTDOOR NETS



BRAIDED POLY NET

- 3mm, 12 loop, braided polyethylene
- 400% more durable than nylon
- Designed for outdoor use

SNBBNPBRY \$3⁹⁹ EA ★



STEEL CHAIN NO-TIE SUPER NET

- 12 loop, zinc plated galvanized steel provides protection from weather
- Includes heavy-duty "S" hooks for attachment to any style rim

SNBBSTLN \$28⁹⁹ EA



PREMIUM STEEL PLAYGROUND NET

- Zinc plated chain is three-times heavier than typical chain nets
- All links are welded into closed loops to prevent separation when chains are stretched during play
- Includes heavy-duty S-hooks for attachment to any style rim

2 Year Limited Warranty

504444XX

\$69⁹⁹ EA



WEB OUTDOOR NET

- Flat strap design improves outdoor durability while maintaining the feel of traditional nylon nets
- Triple-stitched with non-rotting nylon thread
- Includes heavy-duty S-hooks for attachment to any style rim

SNBBN505

\$39⁹⁹ EA ★



MOUNTS AND BRACKETS



BISON ADJUSTO-BRACKET BASKETBALL GOAL MOUNT

- Simply attach the Adjusto-Bracket to any flat surface and slide your goal into place to create a basketball play area
- For use on brick, wood, block or tile
- Goal not included
- 8 1/2"H x 7"W - 2 lbs.

4998XXXX \$89⁹⁹ EA

GOAL FOR ADJUSTO BRACKETS

- For use with single or double Adjusto-Bracket goal mounts

5004XXXX \$74⁹⁹ EA



DOUBLE ADJUSTO-BRACKET GOAL MOUNT

- Allows 12" height adjustment on one bracket to accommodate different age/height requirements
- 17"H x 8 1/2"W - 4 lbs.

4997XXXX

\$129⁹⁹ EA

BACKBOARD PADDING



SAF-GUARD CUSHION EDGE BACKBOARD PADDING

- Soft, durable backboard padding made from high density polyurethane foam with tough outer skin
 - Fits most standard 72" wide glass or acrylic backboards
 - Reinforced, pre-drilled bolt holes for easy installation (mounting hardware included)
 - Meets NCAA and NFHS specifications
 - Indoor use only
- Color Options: **Black, Grey, Navy, Red, Royal Blue.**

BB72 Specify Color **\$179⁹⁹** EA ★



DURASKIN BACKBOARD SAFETY PADDING

- Fits every manufacturers' official 72" backboard but might require frame drilling on non-Bison backboards (will not work with Zip Crank)
- Reinforced, pre-drilled bolt holes for easy installation (mounting hardware included)
- Meets NCAA, FIBA and NFHS specifications
- Indoor use only
- Rectangular color options: **Black, Brown, Burnt Orange, Cardinal, Columbia Blue, Forest Green, Gold, Grey, Kelly Green, Maroon, Navy, Orange, Purple, Royal, Scarlet, Vegas Gold**
- Fan-shaped color options: **Black, Grey, Royal, Scarlet**

10 Year Limited Warranty

5054XXXX For Rectangular Backboards **\$239⁹⁹** EA
5468XXXX For Fan-Shaped Backboards **\$289⁹⁹** EA



PRO-MOLD BACKBOARD PADDING

- Soft, durable backboard padding made from high density polyurethane
 - Fits most standard 72" wide glass or acrylic backboards
 - Reinforced, pre-drilled holes for installation
 - Mounting hardware included
 - Meets NCAA, NBA & NFHS specifications
 - Indoor use only
- Color Options: **Black, Dark Green, Gold, Grey, Kelly, Maroon, Navy, Purple, Royal, Scarlet.**

1092000 Specify Color **\$219⁹⁹** EA



PRO BOLT-ON BACKBOARD PADDING

- Extremely durable molded padding which meets all NBA, NCAA, NFHS and FIBA requirements.
 - Choose from 12 colors
- 3 Year Limited Warranty**
- Color Options: **Black, Dark Green, Grey, Kelly Green, Light Blue, Maroon, Navy, Orange, Purple, Red, Royal, Yellow Gold.**

1383915 Specify Color **\$229⁹⁹** EA



ADHESIVE BACKBOARD PADDING

- Fits 2" Thick Backboards
- Molded from self-skinning polyurethane foam
- Fast-setting adhesive installation
- Pads two backboards

1383987 Specify Color **\$289⁹⁹** PA





FISHER EDGE DIGITALLY PRINTED CHAIR

- Enhanced printing in as many colors and locations as you want for one low price!
- 2 1/2" thick seat padding, 1" padded seat back, 16 gauge steel frame
- Rubber cap ends help protect gym floors
- Frame: Red, Royal, Black, Purple, Forest Green, Maroon, Navy, White, Chrome and Silver
- Vinyl colors: Gold, Black, Cardinal, Forest Green, Graphite, Grey, Gunmetal, Kelly Green, Maroon, Navy, Orange, Purple, Red, Royal, Silver, Teal, Vegas Gold and White
- Minimum order 6
- Ships in 4 weeks after art approval

1383871 \$152⁹⁹ EA

SHIPS IN 4 WEEKS OR IT'S FREE (AFTER ART APPROVAL, EXCLUDES SHIPPING)

CHC100 HANGING CHAIR CART

- Holds 36 chairs
- Dimensions: 80"H x 34"W x 64"L
- Heavy duty steel black powder coated frame
- 4" caster wheels

10 Year Limited Warranty

1399629 126 lbs. \$499⁹⁹ EA



NEXT LEVEL FOLDING CHAIR

- Includes 2-color print up to 3 locations
- 2 1/2" thick seat padding, 1" padded seat back, 16 gauge steel frame
- Maximum logo size for seat cushion is 14"W x 15"H; seat back is 13"W x 5"H; cushion front is 5"W x 13"W
- Rubber cap ends help protect gym floors
- Frame colors: Red, Royal, Black, Purple, Forest Green, Maroon, Navy, White, Chrome and Silver
- Vinyl colors: Gold, Black, Cardinal, Forest Green, Graphite, Grey, Gunmetal, Kelly Green, Maroon, Navy, Orange, Purple, Red, Royal, Silver, Teal, Vegas Gold and White
- Minimum order 6
- Ships in 4 weeks after art approval

10 Year Limited Warranty

1399627 \$134⁹⁹ EA

SHIPS IN 4 WEEKS OR IT'S FREE (AFTER ART APPROVAL, EXCLUDES SHIPPING)



THE EDGE DIGITALLY PRINTED STOOL

- Enhanced printing in as many colors and locations as you want for one low price
- 1-1/2" thick seat padding; 16 gauge steel frame
- Maximum logo size for seat chair is 10" x 10"
- Rubber cap ends help protect gym floors
- Frame: Red, Royal, Black, Maroon, Navy, White and Chrome
- Minimum order 6
- Ships in 4 weeks after art approval

10 Year Limited Warranty

1399628 \$62⁹⁹ EA

SHIPS IN 4 WEEKS OR IT'S FREE (AFTER ART APPROVAL, EXCLUDES SHIPPING)

Bid #ESC NJ 17/18-31
THE STADIUM CHAIR COMPANY



TALL LOCKERSTOOL



LOCKERSTOOL

LOCKERSTOOL

- Padded vinyl seat on strong steel frame
- Folds for easy storage
- Dimensions: 25"H x 14 3/4"W; Seat: 12 1/2" diameter
- Tall LockerStool is 3" taller for more legroom
- Weight capacity: 300 lbs.
- Specify frame color, cushion color and print colors
- Includes 2-color print in 1 location
- Minimum order quantity 24 stools
- Delivery 6-12 weeks after artwork approval

1307313	LockerStool	\$55 ⁹⁹ EA	
1325911	Tall LockerStool	\$59 ⁹⁹ EA	

Tall locker stools

Frame colors: Black, Navy, Red, Royal Blue, White

Vinyl colors: Black, Forest Green, Maroon, Navy, Orange, Red, Royal Blue, Purple, White

Locker Stools

Frame colors: Black, Bright Gold, Forest Green, Kelly Green, Maroon, Navy, Orange, Red, Royal Blue, Purple, White



DELUXE

DELUXE SIDELINECHAIR

- Available with 3" or 2" cushions for same cost
- Dimensions: 40 1/2"H x 17 3/4"W; Seat Dimension: 15 1/4"W x 16"D
- Includes 2-color printing in 2 locations
- Weight capacity: 450 lbs.
- Specify color for frame, cushion and printing
- Minimum order of 24 chairs
- Delivery 6-8 weeks after artwork approval

15 Year Limited Warranty

1307252		\$129 ⁹⁹ EA	
1325928	Optional Ganging Device	\$9 ⁹⁹ EA	

FRAME COLORS: BLACK, RED, NAVY, ROYAL BLUE

VINYL COLORS: BLACK, RED, NAVY, ROYAL BLUE, PURPLE, WHITE, MAROON, FOREST GREEN



SLIP COVER

UNIVERSAL FOLDING CHAIR

- Features curved backrest for lumbar support, with thick, comfortable seat cushion
- No-Slide grippers help keep chair in place
- Dimensions: 32"H x 17 1/2"W x 20"D
- Includes 2-color printing in 2 locations
- Weight capacity: 300 lbs.
- Specify frame, cushion and printing colors
- Minimum order of 24 chairs
- Delivery 6-8 weeks after artwork approval

1307276		\$89 ⁹⁹ EA	
1307283	Slip Cover-1/C Logo	\$19 ⁹⁹ EA	
1325928	Optional Ganging Device	\$9 ⁹⁹ EA	



BASKETBALL



CHAIRCADDIE

- Holds 36 SidelinChairs
- Dimensions: 68 1/4"H x 31 1/2"W x 60"L
- Frame and optional cover - Black only
- Only compatible with StadiumChair products

1307290		\$749 ⁹⁹ EA	
1307306	Canvas Caddie Cover	\$99 ⁹⁹ EA	

GAMECHANGER™ BLEACHER SEAT

- Patented bungee-cord cushioning
- Durable steel frame
- Heavy Cordura canvas seat and back rest
- Hinged back support for added comfort
- Bottom hooks to secure to bleacher
- Folds neatly for easy carry and storage
- Optional chair legs and arm rests for versatile seating
- Available carry bag with side pocket (black only) for easy transportation
- Deluxe version not available in Kelly Green, Brown, Columbia, Gold or Pink

Color Options: **Black, Brown, Columbia, Forest Green, Gold, Graphite, Gray, Kelly Green, Maroon, Navy, Orange, Pink, Purple, Real Tree, Red, Royal.**

1397633	Standard - 17" Wide (350 lb. Capacity)	\$49 ⁹⁹ EA
1397650	Deluxe - 21" Wide (400 lb. Capacity)	\$59 ⁹⁹ EA
1397662	Optional Arm Rest	\$17 ⁹⁹ PR
1397663	Optional Chair Legs (Standard)	\$37 ⁹⁹ EA
1397664	Optional Chair Legs (Deluxe)	\$39 ⁹⁹ EA
1397665	Optional Carry Bag (Standard)	\$13 ⁹⁹ EA
1397666	Optional Carry Bag (Deluxe)	\$15 ⁹⁹ EA



Color Options:

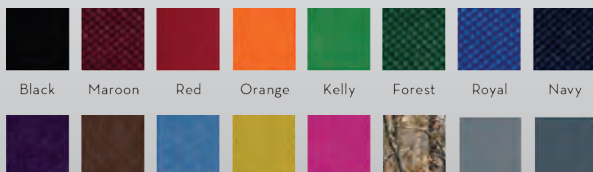



SLIPP-NOTT TRACTION SYSTEM-SMALL

- Used to remove dust, dirt and wax build-up from shoe soles
- Simply walking on it improves traction and maneuverability
- Typical game usage is 2-6 sheets
- 18" x 19" base and (75) - 15" x 18" sheets

1298673 Small Base & Pad Set **\$144⁹⁹** EA
1298680 Repl. Pad (75 sheets) for Small Set **\$58⁹⁹** EA



SLIPP-NOTT TRACTION SYSTEM-LARGE

- Used by professional, college, and high school basketball teams to remove dust, dirt and wax build-up from shoe soles with one quick action
- Simply walking on it improves the traction and maneuverability
- Large set: 28" x 29" base and (75) 26" x 26" sheets

1298697 Large Base & Pad Set **\$259⁹⁹** EA
1298703 Repl. Pad (75 sheets) for Large Set **\$99⁹⁹** EA



BASKETBALL PLAYMAKER DRY ERASE BOARDS

- Heavy duty aluminum framed magnetic 48" x 72" dry erase board
- 1 full court and 2 half courts (roll-a-way version has blank space on opposite side)
- Includes (4) dry erase pens, magnetic pieces with vinyl numbering system and an eraser

1298840 Roll-A-Way Version **\$1,049⁹⁹** EA
1366512 Wall Mount Version **\$599⁹⁹** EA



BASKETBALL SCOREBOOK

- Includes 30 games, 15 player spots, 3-point scoring, team roster, season schedule, season summary, and simplified scoring instructions
- 8 1/2" x 11" spiral bound with soft cover

MSBSKBOK **\$7²⁹** EA



MARK V BASKETBALL SCOREBOOK

- Includes 30 games, 15 player spots, 3-point scoring, team roster, season schedule, season summary, and simplified scoring instructions
- 8 1/2" x 11" spiral bound with hard cover

MSMARKBK **\$8⁹⁹** EA

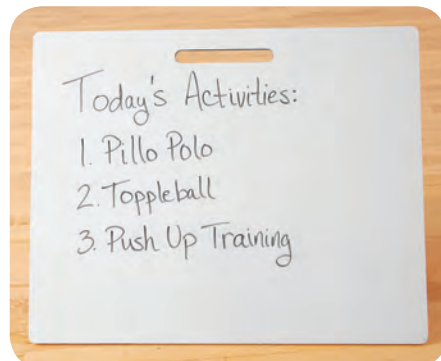

DRY ERASE BOARD

- Large, portable 24"H x 30"W board
- Use to keep score, as a sign, to explain an activity and more
- Features a cut-out handle for carrying

1363637 **\$45⁹⁹** EA ★



BASKETBALL COACH'S BOARD

- Front half court and back full court writing surfaces
- Includes premium dry erase marker
- 8"W x 15 1/2"L

1388107 **\$13⁹⁹** EA ★



Sport Write!
COACHING TOOLS
DRY ERASE BOARDS

- Large format enables entire team to see play
- 2 writing surfaces
- Great pen clip with premium dry erase marker
- 1/2 court featured on back

1405765 12 1/2"H x 16 1/2"W - 2 lbs. **\$29⁹⁹** EA



PORTABLE PLAYMAKER BASKETBALL BOARD

- 18" x 24" durable dry erase board with handle
- Full-court diagram on one side, the other side is a blank, dry erase surface that can be used to flash plays or other information from the sideline

1299786 Includes dry erase pen that attaches to the board **\$41⁹⁹** EA

Bid #ESCNJ 17/18-31







Educational Services Commission of New Jersey

Athletic Equipment & Supplies

FREE STANDING

EVERBRITE SCORERS TABLE

- Shatter resistant polycarbonate illuminated panel slides in and out, making it possible to use different sponsors at different events
- Wood grain laminate counter with access holes for cables and cup holders
- 3" locking casters to prevent movement
- Vinyl padding included available in 8 colors (Black, Blue, Dark Green, Kelly Green, Maroon, Purple and Red)
- Ships fully assembled

1237283	Free Standing - 8'L (3 - 4 People)	\$3,799 ⁹⁹ EA	
1237290	Bleacher Mount - 8' (3 - 4 People)	\$4,199 ⁹⁹ EA	
1397715	Free Standing - 10'L (4 - 5 People)	\$3,999 ⁹⁹ EA	
1397716	Bleacher Mount - 10'L (4 - 5 People)	\$4,699 ⁹⁹ EA	
1397717	Free Standing - 12'L (5 - 6 People)	\$4,399 ⁹⁹ EA	
1397718	Bleacher Mount - 12'L (5 - 6 People)	\$4,899 ⁹⁹ EA	
1397719	Optional Padded Possession Indicator	\$499 ⁹⁹ EA	
1397720	Optional Padded Possession Indicator w/Bonus	\$699 ⁹⁹ EA	

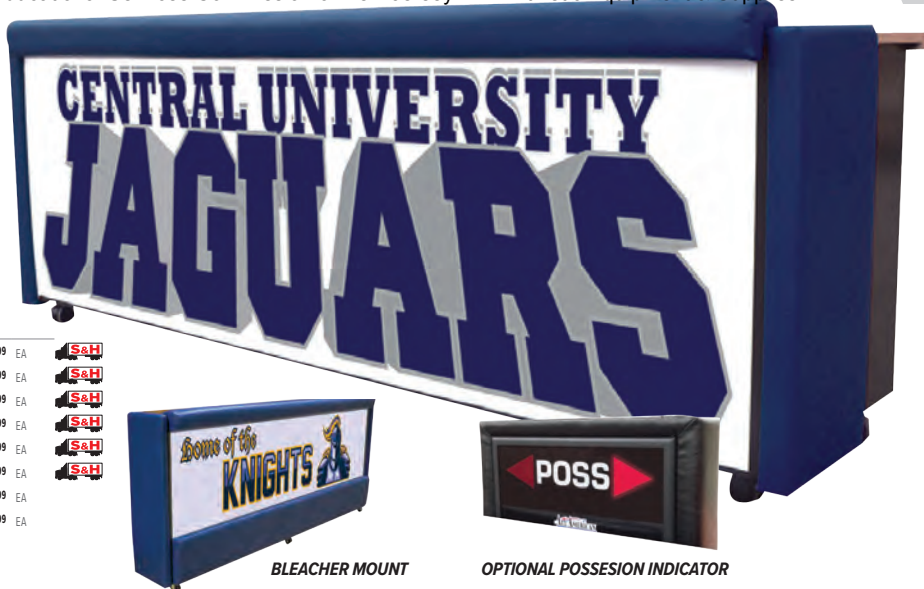

BASKETBALL

GRAPHICS INCLUDED!



SPORT PRIDE SCORERS TABLES

- 8' L x 16"D table will accommodate 4 people
- Folds easily for storage and transports on built-in, floor friendly casters
- Padding is vinyl covered 2" thick urethane foam
- Includes full printed graphics on front panel and school name on side pads
- Includes 4 cup holders and 110v receptacles for electronics
- One hour of free custom artwork; no additional charge when Bison QwikPrint graphic option is selected

1187076	Space Saver Bleacher Model - 46"H	\$3,899 ⁹⁹ EA	
1187069	Convertible Free Standing Model - 34"H	\$3,499 ⁹⁹ EA	
1248371	Cover for Convertible Model	\$329 ⁹⁹ EA	
1248388	Cover for Space Saver Model	\$329 ⁹⁹ EA	



THE ROCK.

BASKETBALL SHOOTING MACHINE

TAKING TRAINING TO THE NEXT LEVEL

- Colorlok Precision-Guided Technology that locks onto the shooter's color of jersey
- Automatically tracks the shooter's every move, every change in direction and every change in speed
- Delivers a Game-Like pass with realistic backspin and velocity
- Multiple Shooters and programmed drills that works any spot on the floor
- Shoot off the dribble or shoot of the catch
- Full-Speed workouts with more reps
- Electronic controls with multiple speeds and selectable shot delay
- Quiet operation; Counts number of shots made
- Light weight, easy setup and take down with one person in just a couple of minutes
- Lifetime limited warranty

1399645	625 lbs.	\$8,999 ⁹⁹ EA
---------	----------	--------------------------





SKLZ
SOLO ASSIST

- Advanced, lightweight construction and true-pass design allows for game-like catch-and-shoot training
- Trains players to catch the ball on the move, set their feet and square up properly before shooting
- Designed for hardwood, outdoor courts and driveways
- Perfect for individual practice or team drills
- Portable and folds flat for easy storage

1393073 25 lbs. \$129⁹⁹ EA



VARSITY TOSS BACK®

- Welded steel frame is equipped with casters for easy movement and can be locked in place with a single hand operated brake lever
- Support post constructed of 2" square steel tubing with a 1 3/4" square telescoping tube for height adjustment
- Height adjusts from 4'5" to 7'4"
- Net frame constructed of 3/4" O.D. steel tubing and measures 38" x 51"
- Overall net dimensions: 27" x 40"
- Net is 2" square mesh made from 3mm braided nylon, secured to frame by (28) specially designed rubber bands

1561XXXX 130 lbs. \$999⁹⁹ EA **SeH**
20001010 Replacement Net and Bands \$159⁹⁹ SET



MASTER TOSS BACK®

- Base frame constructed of 1" O.D. steel tubing and supported by rubber suction cups for stability
- Net frame constructed of 3/4" O.D. steel tubing
- Overall net dimensions: 27" x 36"
- Net is 2" square mesh made from 3mm braided nylon, secured to frame by (22) specially designed rubber bands
- Overall unit size 72"H x 40"W
- Folds closed for easy storage

1271041 36 lbs. \$259⁹⁹ EA



BALLBACK PRO

- Returns the basketball anywhere in a 90 degree arc without needing adjustment
- Installs in seconds - no tools required

1299816 \$29⁹⁹ EA



THE "SHOOTER" RING

- The all steel ring design requires no tools for quick and easy installation
- Attaches to all standard basketball goals to create a smaller diameter rim (17 inches) for improved shooting accuracy

1063732 \$25⁹⁹ EA ★



SKLZ
DOUBLE DOUBLE RING

- 2-in-1 training for more precision shooting and effective rebounding
- Reduces inner rim to 15" to reinforce shooting with correct arc and rotation
- Includes attachable "rejector" ring for rebounding drills
- Durable bent steel construction for true action off the rim
- Easily attaches to standard 18" rims

1393068 \$39⁹⁹ EA



REBOUND DOME

- Constructed of heavy-duty clear lexan molded plastic
- 7 durable rubber mounts snap on and off for easy installation
- Fits all regulation rims
- 5 year warranty

1298819 \$99⁹⁹ EA



DRIBBLE SPECS

- Unique design helps condition players to dribble and handle the ball without looking down

5710XXXX \$5⁹⁹ EA

BASKETBALL COURT STENCIL

- Create your own regulation basketball court on any permanent surface such as asphalt or concrete
- Meets high school and NCAA specs
- No measuring, just roll out the heavy duty paper sections and use the included paint roller to begin painting (paint not included)

MSBBSCSX \$39⁹⁹ SET



Bid #ESCNJ 17/18-31

Educational Services Commission of New Jersey

Athletic Equipment & Supplies

KEYCLEAN PRO

- Clean on the go...play like a pro!
- A large 18" x 24" surface offers full coverage for quick clean-up
- Highly absorbant, specially designed microfiber pads rapidly absorb sweat and moisture
- Reduces potential for slip and falls that can cause serious injury
- Custom Mops - Ships in 2 weeks to ship after art approval

1383869	Set of 2 Mops - Standard	\$339 ⁹⁹ EA
1399641	Set of 2 Mops w/Custom Logo	\$439 ⁹⁹ PACK
1393374	Microfiber Pad - Each	\$44 ⁹⁹ EA



SKLZ

D-MAN HANDS UP DEFENDER

- Learn to shoot or pass over or around the hands-up defending position
- Ideal for solo practice or team settings
- Portable, lightweight, sets up and breaks down easily
- Adjustable telescoping pole (6.5' to 8') gives varying defensive options
- Base and ground stake included for stability

1363683

\$64⁹⁹ EA



BASKETBALL

COURTCLEAN DAMP MOP SYSTEM

- Clean court in minutes
- Improves floor conditions and protects floor finish
- Includes custom sweeper pad, specially designed towel and pull rope
- Works on any hard floor surface

1271058	6' Unit	\$629 ⁹⁹ EA
1271065	6' Replacement Towel	\$39 ⁹⁹ EA
1079709	8' Replacement Towel	\$49 ⁹⁹ EA



SKLZ

DRIBBLE STICK

- Four fully adjustable arms for a variety of drills
- Center top provides storage for ball and arms
- Use in the driveway, gym, garage, or basement
- Includes Dribble Stick, 4 dribble arms and a drills guide
- Durable aircraft aluminum center post with heavy base for stability
- 36 inches high
- Ball not included

1393072

\$99⁹⁹ EA



COURTCLEAN START-UP/TUNE-UP KIT

- Keeps your floors clean and shiny
- Includes 5 gallon bucket, 4 towels and 1 gallon of Shine-All cleaner

1237566	Kit w/8' Towels	\$239 ⁹⁹ EA
1292015	Kit w/6' Towels	\$229 ⁹⁹ EA
1237573	1 gal. Super Shine	\$59 ⁹⁹ EA

SKLZ

CONTROL BASKETBALLS

- High-quality synthetic leather construction for training indoors and out
- Lightweight ball / 22.5" - increases effectiveness of dribbling drills by forcing players to concentrate on the smaller size and react to a faster bounce
- Official Weight ball / 22.5" - smaller size requires greater focus and forces players to pound the ball when dribbling, increasing ball control, while improving muscle memory
- Heavy Weight ball / 29.5" - 3 lbs. but engineered to bounce identically to a regulation ball. The extra weight makes it perfect for strengthening fingers, wrists and forearms for improved ball handling, passing and rebounding

1393069

Lightweight - 22.25"

\$29⁹⁹ EA

1393070

Official Weight - 22.5"

\$34⁹⁹ EA

1393071

Heavy Weight - 29.5"

\$44⁹⁹ EA





MONSTER BALL CART

- Fabricated from 1" square steel
- Black powder coated finish
- Holds 15 official size basketballs

7 Year Limited Warranty

1162608 30"H x 49"W x 20"D - 30 lbs. **\$299⁹⁹** EA ★



DOUBLE MONSTER BALL CART

- Fabricated from 1" square steel
- Black powder coated finish
- Holds 30 official size basketballs

7 Year Limited Warranty

1162615 30"H x 49"W x 24"D - 54 lbs. **\$439⁹⁹** EA ★



BASKETBALL BUTLER

- Keep basketballs off the ground and ready to use
- Welded steel with powder coated finish
- Attaches to round posts up to 4 1/2" O.D. (hardware included)
- Can also be wall mounted (hardware not included)

1249156 2 Ball **\$59⁹⁹** EA
1253641 4 Ball **\$119⁹⁹** EA



**3-ROW
12 BALLS**



15 BALL CART

- Heavy duty chrome steel rods
- Solid triangular frames for strength and stability
- Non-marring casters
- Wide base design prevents tip over
- Holds 15 official size basketballs

1159639 38"H x 51"W x 19"D - 10 lbs. **\$109⁹⁹** EA ★



50 BALL CART

- Constructed of 1" O.D. black powder coated steel tubing
- Heavy duty urethane swivel wheels - 2 with brakes
- 5 welded shelves make for easy assembly
- Will hold 50 official size basketballs
- Fits through standard doorways

1378673 64"H x 24"W x 61"L - 61 lbs. **\$299⁹⁹** EA ★



**4-ROW
16 BALLS**



HEAVY-DUTY BALL CARTS

- Welded 1" square wall tubing with 3/4" steel chrome plated, ball support arms
- Non-marring, high quality 360° swivel casters
- Extra wide wheel base avoids tipping
- Add a school or mascot name, up to (10) letters, to the end panels (lettering sold separately and is not applied by manufacturer)

5 Year Limited Warranty

Color Options: **Grey, Royal Blue, Scarlet, White.**

1048452 12 Ball Cart **\$349⁹⁹** EA
1048450 16 Ball Cart **\$399⁹⁹** EA
1245899 Lettering **\$79⁹⁹** EA

NEW!

WIDE BODY BALL CARTS

- Heavy duty white powder coated steel tubing
- Non-marring, hard rubber casters with a wide, no-topple base
- Designed for easy storage and removal of balls
- 12 Ball Cart - 40"W x 40"H x 16"D
- 16 Ball Cart - 40"W x 52"H x 16"D

BCART12W 12 Ball Cart **\$79⁹⁹** EA ★
BCART16W 16 Ball Cart **\$79⁹⁹** EA ★



DOUBLE-WIDE BALL CART

- Made of 1" rugged chrome steel
- Holds 30 full size basketballs

1237634 33"H x 45"W x 24"D - 35 lbs. **\$179⁹⁹** EA ★



TEAM NBA.
PLAYERS. TEAMS. DREAMS.



BASKETBALL

NBA REPLICA JERSEYS

- 100% colorfast polyester Double ply, eXtreme tear drop fully reversible jersey-soft, cool, lightweight mock mesh material
- Open hemmed bottom for decoration
- Authentic NBA logos on center front and reverse side
- NBA logoman on upper left side and NBA women jock tag for identification

AAA105LA Youth S-L, Adult S-XL \$19⁹⁹ EA



NBA REPLICA SHORTS (BLANK)

- 100% colorfast polyester solid color single ply short
- 1.5" exposed elastic waistband, inside drawcord
- Cover hemmed leg openings
- Inseams: Adult S-XL (9"), Youth Small (7"), Youth Medium (8"), Youth Large (9")
- Color Options: Black/Scarlet, Black/White, Kelly/White, Navy/White, Purple/Lt Gold, Orange/White, Royal/Orange, Royal/White, Scarlet/White, Thunder Blue/Navy



A205Y Youth S-L \$11⁹⁹ EA
A205A Adult S-XL \$12⁹⁹ EA



SIZE CHARTS FOR BASKETBALL UNIFORMS

MEN	S	M	L	XL
CHEST	34-36	38-40	42-44	46-48
WAIST	26-28	30-32	34-36	38-40

YOUTH	S	M	L
SIZE	6-8	10-12	14-16
CHEST	28-30	32-34	36-38
WAIST	20-22	24-26	28-30

NUMBERING

FULL BLOCK NUMBERS CAN BE ADDED TO ANY NBA JERSEY!





ALLESON TRICOT MESH REVERSIBLE JERSEY

AA560R	Men's S-4XL	\$13 ⁹⁹ EA
AA560RW	Women's S-3XL	\$13 ⁹⁹ EA
AA560RY	Youth S-L	\$11 ⁹⁹ EA

100% Polyester, 70 Denier Tricot Mesh. Double thickness body. Oversized cut with wide shoulder design. Open bottom for printing.

Color: BK/LT GO, BLK/ORG, BLK/SCA, BLK/WHT, BRN/WHT, CLB/WHT, CRD/WHT, DGR/WHT, KEL/WHT, L GO/WHT, MAR/L GO, MAR/WHT, NVY/L GO, NVY/WHT, ORG/WHT, PUR/L GO, PUR/WHT, ROY/L GO, ROY/SCA, ROY/WHT, SCA/WHT, TX OR/WHT, V GO/NVY, V GO/WHT

NFHS APPROVED ALLESON 535 JERSEY & SHORT

AA535J	Men's Jersey S-3XL	\$19 ⁹⁹ EA
AA535JY	Youth Jersey S-XL	\$14 ⁹⁹ EA
AA535P	Adult Short S-3XL	\$19 ⁹⁹ EA
AA535PY	Youth Short S-XL	\$14 ⁹⁹ EA

100% eXtreme Plaited Cationic Polyester with moisture management fibers. Curved shoulder inserts to improve fit and movement. Entire uniform is top stitched for durability, appearance, and comfort. NFHS legal.

Black/Scarlet, Black/White, Charcoal/White, Columbia Blue/White, Dark Green/White, Electric Yellow/Charcoal, Kelly/White, Maroon/White, Navy/Scarlet, Navy/White, Orange/White, Pink/White, Purple/White, Royal/White, Scarlet/White, White/Black, White/Navy, White/Pink, White/Royal, White/Scarlet

NFHS APPROVED ALLESON 537 JERSEY & SHORT

AA537J	Men's Jersey S-3XL	\$16 ⁹⁹ EA
AA537JY	Youth Jersey S-XL	\$14 ⁹⁹ EA
AA537P	Men's Short S-3XL	\$16 ⁹⁹ EA
AA535PY	Youth Short S-XL	\$14 ⁹⁹ EA

81% Cationic Colorfast Polyester/19% Spandex no-pull fabric with moisture management fibers. Entire uniform is top stitched for durability. Solid color uniform with extreme plaited knit and pin dot mesh. Jersey is NFHS legal.

Black/White, Charcoal/White, Cardinal/White, Dark Green/White, Maroon/White, Navy/White, Purple/White, Royal/White, Scarlet/White, White/Black, White/Navy, White/Royal, White/Scarlet



ALLESON TRICOT MESH SHORT

AA566PY	Youth S-L, 6" Inseam	\$11 ⁴⁹ EA
AA567P	Adult S-4XL, 7" Inseam	\$13 ⁹⁹ EA
AA569P	Adult S-4XL, 9" Inseam	\$13 ⁹⁹ EA
AA5611P	Adult S-4XL, 11" Inseam	\$14 ⁹⁹ EA

100% Polyester, 70 Denier Tricot Mesh. Double thickness body. 1-1/2" Covered elastic waistband with inside drawcord.

Black, Brown, Cardinal, Columbia Blue, Dark Green, Kelly, Light Gold, Navy, Orange, Purple, Royal, Scarlet, Texas Orange, Veg Gold, White



CLUTCH BASKETBALL REVERSIBLE JERSEY

1382584	Adult S-3XL	\$14 ⁹⁹ EA
1382645	Youth S-XL	\$14 ⁹⁹ EA

100% Polyester, DRI GEAR. Interlock fabric has a silky smooth feel. Lightweight and snag resistant.

Black/White, Cardinal/White, Charcoal/White, Forest Green/White, Gold/White, Lt Blue/White, Maroon/White, Navy/White, Royal/White, Scarlet/White

CLUTCH BASKETBALL SHORT

1382686	Adult S-3XL	\$12 ⁹⁹ EA
1382947	Youth S-XL	\$12 ⁹⁹ EA

100% Polyester, DRI GEAR. Interlock fabric has a silky smooth feel. Lightweight and snag resistant. 2" Elastic waistband with drawstring.

Black, Cardinal, Charcoal, Forest Green, Gold, Light Blue, Maroon, Navy, Royal, Scarlet



MUSCLE BASKETBALL JERSEY & SHORT

1382128	Men's Jersey S-3XL	\$14 ⁹⁹ EA
1382237	Youth Jersey S-XL	\$14 ⁹⁹ EA
1382402	Adult Short S-3XL	\$12 ⁹⁹ EA
1382511	Youth Short S-XL	\$12 ⁹⁹ EA

100% Polyester, DRI GEAR. Interlock fabric has a silky smooth feel. Lightweight and snag resistant.

Black/White, Cardinal/White, Forest Green/White, Gold/White, Lt Blue/White, Navy/White, Purple/White, Royal/White, Scarlet/White, White/Black, White/Black, White/Cardinal, White/Forest Green, White/Gold, White/Lt Blue, White/Navy, White/Purple, White/Royal, White/Scarlet



POSITION MATCH WRISTBANDS

- Includes 5 pair of wrist bands, each pair a different color
- The player guards the player on the other team that is wearing the same colored wrist band
- Great aide for younger players to remember who they are guarding
- Use colors to Mark

1296754	\$8 ⁹⁹ EA
---------	----------------------



CHARGE BASKETBALL JERSEY & SHORT

1389189	Men's Jersey S-3XL	\$19 ⁹⁹ EA
1389286	Youth Jersey S-XL	\$17 ⁹⁹ EA
1389351	Men's Short S-3XL	\$19 ⁹⁹ EA
1389448	Youth Short S-XL	\$17 ⁹⁹ EA

100% Polyester mid-weight uniform. Matching color mesh curved upper back panel. Hemmed bottom and armholes. Short has 2" cover elastic waist with inside drawcord. Adult inseam is 10", Youth is 7".

Black/White, Forest Green/White, Maroon/White, Navy/White, Orange/White, Purple/White, Royal/White, Scarlet/White, White/Black, White/Forest Green, White/Maroon, White/Navy, White/Orange, White/Purple, White/Royal, White/Scarlet



REFEREE/OFFICIALS V-NECK JERSEY

- 100% polyester in alternating colors-Black and White
- Black v-neck collar and sleeve trim
- Hemmed straight bottom

1157623	M-XL	\$27 ⁹⁹ EA *
1157703	XXL	\$28 ⁹⁹ EA *
1157710	XXXL	\$29 ⁹⁹ EA *



NEW!

PIVOT REVERSIBLE JERSEY & SHORT

CPBBJ14	Jersey S-3XL	\$19 ⁹⁹ EA
CPBBS14	Short S-3XL	\$19 ⁹⁹ EA

Lightweight, 100% Polyester interlock jersey body. 2-Color tapered side interts. 2 Color self-material mitered V-neck collar. Self-finished armholes. Double needle hemmed straight bottom. 2" Covered elastic waistband with drawcord. Reversible cord. Double-needle hemmed leg opening.

Black/White, Forest Green/White, Maroon/White, Navy/White, Orange/White, Purple/White, Royal/White, Scarlet/White



PRO-DOWN

OFFICIALS JERSEY

- 100% polyester
- Styled with zipper and 1 1/4" black cuff on sleeve end

C58	M-XL	\$29 ⁹⁹ EA *
C58XXL	XXL	\$30 ⁹⁹ EA *
C58XXLG	XXXL	\$31 ⁹⁹ EA *

COMPOSITE FOOTBALLS



MacGregor
COMPOSITE SERIES

- Composite leather construction
- Tackified cover for superior grip control
- Double leather laced for additional control
- Nylon wound carcass provides superior shape and air retention

1227697	Official Size	\$21 ⁹⁹ EA ★
1227680	Youth, 12-14	\$20 ⁹⁹ EA ★
1227673	Junior, 9-12	\$19 ⁹⁹ EA ★
1227666	Pee Wee, 6-9	\$18 ⁹⁹ EA ★



Nike
VAPOR 24/7 COMPOSITE SERIES

- Tacky synthetic leather for great grip
- Quarterback-preferred shape is designed for better spirals
- Traditional TPU bladder for consistent shape retention
- Extruded lace system provides durability and feel

1399623	Official Size	\$24 ⁹⁹ EA
1399624	Youth, 12 - 14	\$24 ⁹⁹ EA
1399625	Junior, 9 - 12	\$24 ⁹⁹ EA
1399626	PeeWee, 6 - 9	\$24 ⁹⁹ EA



Wilson
F1001 NCAA® OFFICIAL

- Exclusive 899 WE leather construction
- 1001 pattern-with ACL lacing, dual sided lace re-inforcers with grip stripes
- Multi-layered lining and 3-ply bladder
- Pro pattern

1335675	Official Size	\$86 ⁹⁹ EA
---------	---------------	-----------------------



Wilson
TD COMPOSITE SERIES



- Premium composite leather construction with high definition pebble
- ACL lacing system for better grip and control
- Official size is NFHS approved

1239454	Official Size	\$36 ⁹⁹ EA
1239461	Youth, 12-14	\$34 ⁹⁹ EA
1239478	Junior, 9-12	\$33 ⁹⁹ EA
1239485	Pee Wee, 6-9	\$33 ⁹⁹ EA



Wilson
GST COMPOSITE SERIES



- Premium composite leather construction with high definition pebble
- ACL lacing system provides better grip
- Popular lighter color GST look
- Official size is NFHS approved

1297287	Official Size	\$40 ⁹⁹ EA
1297294	Youth, 12-14	\$38 ⁹⁹ EA
1297300	Junior, 9-12	\$36 ⁹⁹ EA
1297317	Pee Wee, 6-9	\$36 ⁹⁹ EA



Rawlings
R2 COMPOSITE SERIES



- Clutch Composite Design cover
- Stitched stripe construction
- R-Grip™ rubberized lace
- Official size is NFHS approved

RWR2CFBB	Official Size	\$40 ⁹⁹ EA
RWR2CFBYB	Youth, 12-14	\$36 ⁹⁹ EA
RWR2CFBJB	Junior, 9-12	\$33 ⁹⁹ EA



AUTOGRAPH FOOTBALL

- Synthetic leather (PVC) cover
- For display purposes ONLY
- 3 white panels for autographs

1072518	Official Size	\$20 ⁹⁹ EA ★
---------	---------------	-------------------------



Wilson
TR RUBBER FOOTBALL

- All weather sponge-rubber cover
- Double laced

1326062	Official Size	\$22 ⁹⁹ EA
---------	---------------	-----------------------



MIKASA
SPORTS
RUGBY BALL

- Stitched match ball
- Rubber four fold polyester cover
- Butyl bladder for maximum air retention
- Official Size

1303674	Official Size	\$32 ⁹⁹ EA
---------	---------------	-----------------------

LEATHER FOOTBALLS

FOOTBALL



Wilson
TD LEATHER SERIES



- Wilson 899 WE Leather Lockstich construction with TD series pattern preferred by high schools
- Patented ACL Lacing System with dual sided lace re-inforcers
- Wilson® exclusive grip stripes
- Official size is NFHS approved

3F1205R	Official Size	\$79⁹⁹ EA
3F1300	Youth, 12-14	\$51⁹⁹ EA
3F1360	Junior, 9-12	\$48⁹⁹ EA
3F1382B	Pee Wee, 6-9	\$46⁹⁹ EA



Wilson
F1005 NCAA OFFICIAL



- Exclusive 899 WE leather construction
- 1005 "Small" pattern-with ACL lacing, dual sided lace re-inforcers with grip stripes
- Multi-layered lining and 3-ply bladder
- Collegiate pattern

3F1005R	Official Size	\$86⁹⁹ EA
----------------	---------------	-----------------------------



Wilson
GST-P3 OFFICIAL PRACTICE

- Wilson 863 WE Premium Leather
- 1003 pattern, double laced
- Wilson Grip Stripes (not sewn)
- Puritan stitch construction

1014082	Official Size	\$69⁹⁹ EA
----------------	---------------	-----------------------------



Wilson
GST LEATHER SERIES



- Wilson 863 WE leather construction with tanned-in tack, deeper pebble and firmer texture
- Exclusive sewn in grip stripes are 82% more grippable than painted on stripes
- ACL Lacing with dual sided lace re-inforcers
- Official size is NFHS approved

3F1003	Official Size	\$89⁹⁹ EA
1167931	Youth, 12-14	\$59⁹⁹ EA
1167939	Junior, 9-12	\$54⁹⁹ EA
1167948	Pee Wee, 6-9	\$51⁹⁹ EA



SPALDING
J5V ADVANCE



- SBR Foam backing for softer feel and improved handling
- Rubberized laces with diamond cross weave design for improved grip
- 4-ply water resistant liner maintains weight consistency in all weather

1419983	Official Size	\$79⁹⁹ EA
----------------	---------------	-----------------------------



SPALDING
ALPHA



- Horween® "S" tack leather cover for improved grip
- Boxed sewn strip for easy point of reference
- Raised diamond lace for better grip
- Hartco liner for the best shape retention

1388060	Official Size	\$89⁹⁹ EA
----------------	---------------	-----------------------------



VAPOR ONE SERIES



- Used in numerous D1 college programs
- Custom crafted premium tacky leather for a broken-in feel
- Innovative stitched-in TEXTURED half stripe to deliver the perfect feel to every quarterback
- Official size is NFHS approved.

1399621	Official Size	\$89⁹⁹ EA
----------------	---------------	-----------------------------

RUBBER FOOTBALLS



MacGregor RUBBER FOOTBALL

- Pebble grained exterior
- Raised molded laces and simulated seams
- All weather, all surface play

MCX2LXXX	Official Size	\$12⁹⁹ EA ★
MCX2YXXX	Youth, 12-14	\$11⁹⁹ EA ★
MCX2JXXX	Junior, 9-12	\$10⁹⁹ EA ★



Voit ENDURO RUBBER FOOTBALL W/STITCHED LACES

- Pebble grained sewn rubber panels
- Composite stitched laces
- Butyl bladder for better shape and air retention
- Plays and feels better than a molded rubber ball

1376978	Official Size	\$16⁹⁹ EA ★
1376979	Youth Size, 12-14	\$15⁹⁹ EA ★
1376980	Junior, 9 - 12	\$14⁹⁹ EA ★



Voit PLAYGROUND TOUGH RUBBER FOOTBALL

- Pebble grained exterior
- Raised molded laces and simulated seams
- All weather, all surface play

2 Year Limited Warranty

VCF9SHXX	Official Size	\$13⁹⁹ EA ★
VCF7SHXX	Youth, 12-14	\$12⁹⁹ EA ★
VCF6SHXX	Junior, 9-12	\$11⁹⁹ EA ★
VCF5SHXX	Pee Wee, 6-9	\$10⁹⁹ EA ★

BSN SPORTS



TEAM EQUIPMENT BAG

- Heavy duty polyester equipment bag
- Rugged nylon zipper with wrap around handles
- Black only

1377678	33"L x 12"W x 15"H	\$19⁹⁹ EA ★
----------------	--------------------	-------------------------------



FOOTBALL STAT BOOK

- Simplified instructions for charting offensive and defensive plays
- 11 game stat book with 24 play charts per quarter

1197631	\$7²⁹ EA
----------------	----------------------------



FOOTBALL BALL BAG

- Holds 12 official size footballs
- Heavy-duty 600 Denier polyester construction with rugged nylon zipper with wrap around handles and shoulder strap
- Interior dividers separate dry from wet footballs
- Includes zippered pockets on both ends for extra storage
- Available in Black only

1377679	18" x 24" x 9"	\$69⁹⁹ EA ★
----------------	----------------	-------------------------------



FOOTBALL COACH'S BOARD

- Front football play design and back full field writing surfaces
- Includes premium dry erase marker
- 8"W x 15 1/2"L

1398100	\$13⁹⁹ EA ★
----------------	-------------------------------



Wilson
GAME BALL PREP KIT

- Conditions leather for maximum tack and extended use of game balls
- Wax bar lasts longer for frequent use
- Durable brush withstands rough application and buffing

1375489 \$27⁹⁹ EA



NEW!
FOOTBALL CONDITIONING KIT

- Conditions leather for extended game ball use
- Provides maximum tack for improved grip and handling
- Durable wood handle brush for buffing leather
- Long lasting wax bar for frequent use

1399650 \$19⁹⁹ EA ★



QB TEE FOOTBALL DRILL TEE

- Countdown timer begins when ball is lifted from tee
- Adjustable timer with audible beep
- Designed for indoor or outdoor use

1083873 \$149⁹⁹ EA



KICKOFF TEE

- Universal style rubber kicking tee

1405560 1 in. \$4⁴⁹ EA
MSKICKOF 2 in. \$4⁴⁹ EA ★



SOCCER STYLE KICKING TEE

- Unique design allows soccer style kickers to make contact with the ball first, instead of the tee
- Weighted for stability

MSSKTRFX Right Footed Kicker \$4⁴⁹ EA ★
MSSKTLFX Left Footed Kicker \$4⁴⁹ EA ★



GROUND ZERO
GROUND ZERO KICKING TEE

- Heavy duty black rubber tee
- 1" includes on-side kick feature; 2" does not
- Used by NFL Super Bowl teams

FBGZ1 1" \$24⁹⁹ EA ★
1405590 2" \$29⁹⁹ EA

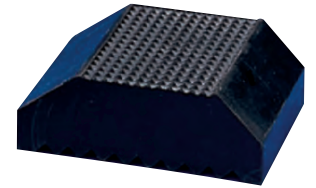

PLACEKICK TEE

- Heavyweight black rubber tee
- Serrated bottom for holds on grass or turf

1405565 1 in. \$4⁴⁹ EA
MSPATXXX 2 in. \$4⁴⁹ EA ★



SKLZ
UNIVERSAL 4-IN-1 KICKING TEE

- Durable rubber with multiple height configurations
- Gripping notches hold the ball firmly in place
- Use as a 1" or 1.75" kick-off tee for regular/onside kicks or as 1" or 1.75" place kicking tee

1384285 \$20⁹⁹ EA



Wilson
PRO KICK

- Collapsible sturdy all-metal construction
- Holds any size football to the desired angle
- Works with or without kicking tee
- Football sold separately

1008579 \$31⁴⁹ EA



WIZARD KICKING STIX® FOOTBALL HOLDER

- Durable powder coated steel and aluminum construction
- Riveted legs for easy, quick fold-up design
- Works with or without place kick tee
- Football sold separately

1363687 \$33⁹⁹ EA



SPORTS-DRY BALL DRYING COMPOUND

- Two bags of compound per box
- Put compound into pail or sealed container and shake balls for 15 - 30 seconds
- Use on footballs, baseballs, tennis balls, etc.
- Once opened, you must keep the Sports-Dry in an airtight container

1420333 \$79⁹⁹ EA



FOOTBALL PLAYMAKER

- 18" H x 24" W dry erase coaching board with handle
- Football field on one side with play diagrams on other side
- Includes dry-erase pen that attaches to the board with Velcro

1297510 \$29⁹⁹ EA



Sport Write!
PRO FOOTBALL DRY-ERASE BOARDS

- Large format enables entire team to see play
- 2 writing surfaces
- Includes pen clip with dry erase marker

1405180 \$29⁹⁹ EA



PRO DOWN

PASS AND SNAP TRAINER

- Steel powder coated base and anodized aluminum upper frame
- 4'H x 4'W pocket with movable target
- Adjust pocket from 30 to 90 degrees
- 6" heavy-duty casters

FB0BTXXX 96"H x 51"W x 48"D \$699⁹⁹ EA ★ **S&H**
FB0BTN Replacement Net \$99⁹⁹ EA ★

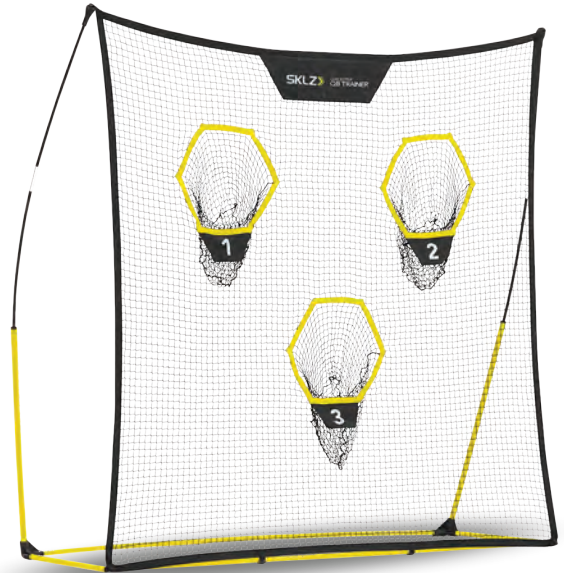

SKLZ

QUICKSTER QB TRAINER

- Pro-style training with total portability
- Three numbered targets assist in throwing accuracy
- Can be used at home or on the field
- Utilizes Tension-Tite Frame Technology
- Lightweight and portable for quick and easy setup

1393066 7'H x 7'W \$159⁹⁹ EA



PASSING DRILL NET

- Designed to aid in teaching quarterbacks the mechanics of setting up, throwing and follow through
- 3 fixed targets & 2 removable targets that can be placed in desired locations
- 1.75" mesh, 2.5 mm braided, knotless, HTPP Black netting with vinyl boarder
- Grommets provided along bottom for staking during high wind conditions
- Attaches to Football Goal Crossbar with sewn in hook & loop straps

1375096 11'H x 18'6"W \$299⁹⁹ EA ★



SKLZ

QB TRAINER PRO

- Designed by and for quarterbacks
- Three targets represent key receiving areas – shoulders, chest and a top target for fade and touch passes
- Provides instant feedback by rejecting off-target passes and returning accurate throws at the bottom of the net
- Built with a heavy-duty steel frame and durable net to stand up to pro-level impact passing
- Frame includes wheels for on-field mobility and the entire unit folds down into a storage bag for convenient storage

1394984 8'6"H x 5'W - 50 lbs. \$499⁹⁹ EA



DEADON

SPORTS TARGET

- Ideal training for the quarterback or long snapper
- Provides a precise point of impact while blocking out visual noise
- Superior training results using Mind-Mapping which graphically represents your training to easily recall, analyze, comprehend and adjust your pass or snap.

1370899 5'6" x 18' - 5/8/20: Extended to 5/8/21 \$99⁹⁹ EA ★



SIDELINE NET PRO

- Ideal sideline warm-up net for punters and kickers
- Features a detachable front panel that can be lowered for punts or attached for placekicking
- Built with heavy-duty netting and a weighted steel for maximum stability and seasons of use
- Unique top panel design helps prevent the net from tangling
- Goes up in minutes and folds down quickly into a convenient roller bag for travel and storage

1394975 7'6"H x 4'W - 28 lbs. \$399⁹⁹ EA



SKLZ SOLO FOOTBALL PASSING TRAINER

- Maximizes your passing and punting reps, while building crucial muscle memory
- Returns your punts and passes without returning the ball too quickly
- Features a unique swivel that allows for a true spiral on both passes and punts
- Works for both left- and right-handed passers and kickers
- Holds footballs of any size and returns them safely
- Fits waist sizes

1393067 \$15⁹⁹ EA



PRO-DOWN

CARRY BAG SOLD SEPARATELY.

VARSITY KICKING CAGE

- Heavy-duty 1 1/2" round 17-gauge galvanized steel frame
- Optic yellow sides help kickers visualize goal post
- Assembles and disassembles easily for travel and storage
- 82"H x 41"W x 41"D - 27 lbs.
- Carry bag sold separately

1052480	Complete Unit	\$169 ⁹⁹ EA ★
1052473	Replacement Net Only	\$51 ⁹⁹ EA ★
1363685	Carry Bag	\$69 ⁹⁹ EA ★

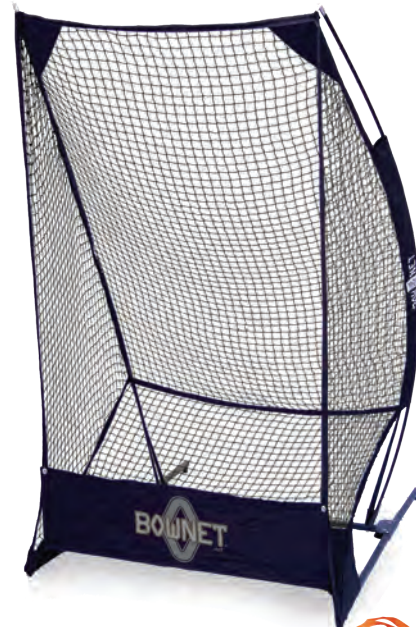

Bow NET

SOLO KICKER

- Unique design makes it the most portable practice Kicker net ever
- Powder coated steel ground frame, and composite Bow Poles
- No tools needed and sets up easily in 90 seconds.
- 7'4"H x 4'W x 5'6"D - 23 lbs.



CARRY BAG INCLUDED!

1367618 Complete Unit \$499⁹⁹ EA

REACTOR
BY CHAMPION BARBELL

FIXED RUNG AGILITY LADDER

- Ideal for developing quick and accurate foot speed, increased balance and coordination
- Each ladder is 15'L x 20"W with ten sections
- Rugged 1" wide webbing with end buckles allow various shape configurations for a more diversified workout
- Connecting buckles allow for additional ladders for longer runs and different formations
- Includes carry bag

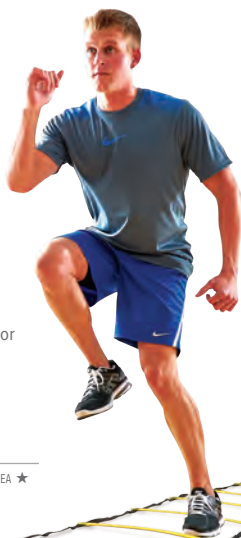

1248548

\$44.99 EA ★

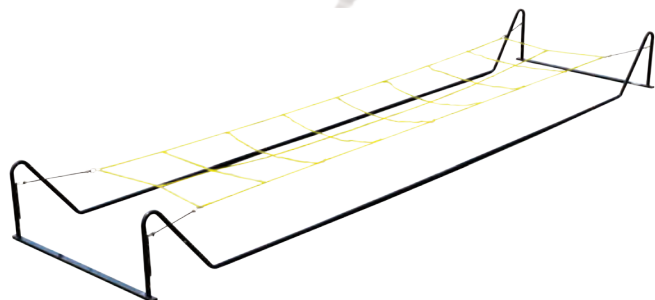

RUNNING ROPES



- Frame constructed of powder-coated 17-gauge steel tubing
- Exclusive frame design keeps all tubing safely away from the training path
- Optic yellow nylon step grid is 14' 10"L x 3' 3"W
- Frame dimensions: 18' 6"L x 4' 6"W, grid adjusts from 6" to 15" H
- Step grid connects to frame with bungee cords

1201987

Complete Unit

\$249.99 EA ★

1201994

Replacement Running Grid

\$74.99 EA ★

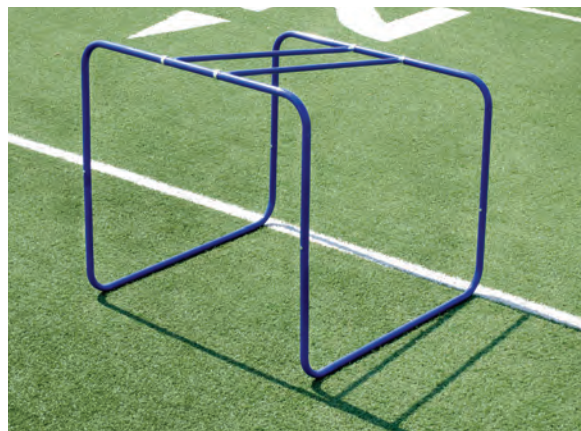

VARSITY LINEMAN CHUTE

- Heavy-walled 1 5/8" powder coated steel tubing
- Entrance height is fixed at 40" and exit height is fixed at 48"
- Assembled dimensions: 50"L x 50"W
- Includes hardware

FBVCHUTE

\$179.99 EA ★



ADJUSTABLE LINEMEN SPLIT MARKER

- Heavy-duty vinyl construction w/ weights at the ends & center keeping it flat on the ground
- The labeled removable positions attaching a hook-&-loop fastening strip to customize formations
- 39"L overall, 10.5"W black strip with 36"L yellow position indicators labeled with 9"H letters
- Great for teaching linemen and backs splits and gaps

200234007

\$165.99 EA ★



SNAPPER STICK



- Aluminum pole with foam rubber football
- Teach players to react to ball movement not cadence
- Telescoping aluminum pole extends from 30" to 60"
- Allows coach to stand instead of kneeling

1299939

\$45.99 EA ★



COLLEGIATE LINEMAN CHUTE



- Double overhead bars keep players low at snap and allows them to rise after first few steps of drive
- Sturdy build 2" Galvanized Steel tubing
- Designed to slide easily across fields with no damage to turf
- Entrance height is 45" and exit height is 52"
- Assembled dimensions - 48"W x 60"L
- 1 man base unit required and then add on as many sections as needed
- Weighs 68.5 lbs.

1272981

Add-a-Chute

\$199.99 EA ★





POP-UP DUMMY

- Three-layer 18 oz. vinyl covered high impact foam construction
- Weighted rubber coated base allows dummy to "pop" back up after contact
- Includes 4 carry handles
- Please specify color (see below for choices)

Color Options: **Black, Forest Green, Gold, Grey, Kelly Green, Maroon, Navy, Orange, Purple, Royal, Scarlet.**

1240153	Junior - 45" X 24" - 80 lbs.	\$459 ⁹⁹ EA	
1240160	Varsity - 60" X 24" - 115 lbs.	\$589 ⁹⁹ EA	
1240177	Pro - 72" X 24" - 125 lbs.	\$669 ⁹⁹ EA	



TACKLE WHEEL

- Teaches players to adjust their angle of pursuit
- Teaches open field tackling and reducing injuries without the use of other players
- Teaches players to wrap up in open field
- 22 oz. coated vinyl in center hole and outside surface
- 19 oz. coated vinyl on outside faces of wheel

1392982	28"OD x 14"ID - 21 lbs.	\$169 ⁹⁹ EA	
1392983	36"OD x 16"ID - 32 lbs.	\$299 ⁹⁹ EA	
1392984	42"OD x 20"ID - 16 lbs.	\$349 ⁹⁹ EA	
1395043	48"OD x 25"ID - 21 lbs.	\$429 ⁹⁹ EA	
1395044	54"OD x 28"ID - 24 lbs.	\$499 ⁹⁹ EA	
1395045	60"OD x 30"ID - 27 lbs.	\$549 ⁹⁹ EA	



SOLD SEPERATELY

AGILITY HOOP

- Practice getting off the line and around the corner
- Made of sturdy PVC piping
- Assembles in seconds

1344158	12" Dia Hoop	\$99 ⁹⁹ EA
---------	--------------	-----------------------

IMPACT BALL

- Helps teach proper footwork and handwork
- Practice defending against opponent getting into knees
- Weighs 40 lbs. for impact resistance

1344165	36" Dia Ball	\$399 ⁹⁹ EA
---------	--------------	------------------------



FOLDING CHUTE BOARD

- High impact foam covered with 18 oz. vinyl
- Helps teach players to stay in blocking lanes
- Folds in half and includes handles

1291803	Yellow Only - 27" H x 12" W x 66" L	\$124 ⁹⁹ EA
---------	-------------------------------------	------------------------



HALF ROUND AGILITY DUMMY

- Curved surface reduces ankle injuries and improves player safety
- Designed to increase foot speed and agility
- Dual purpose dummy for stepover or blocking
- Two durable web handles
- 18 oz. vinyl cover - available in 11 colors

1392985	42" L x 12" W x 6" H - 11 lbs. - Black Only	\$79 ⁹⁹ EA
1392986	42" L x 12" W x 6" H - 11 lbs. - Specify Color	\$95 ⁹⁹ EA
1392998	42" L x 16" W x 8" H - 17 lbs. - Black Only	\$119 ⁹⁹ EA
1392999	42" L x 16" W x 8" H - 17 lbs. - Specify Color	\$139 ⁹⁹ EA

DUMMIES & PADS



- Double-reinforced 18 oz. vinyl shell
- Durable foam interior

- **Black ProDown in stock**
- **Other colors ship from Fisher Athletic. Allow 2-3 Wks for delivery**



COLLEGIATE SHIELD

- 2 reinforced handles
- 16"W x 26"L - 4 lbs.

200232812	Black Only - 6"H	\$69⁹⁹ EA ★
1393022	Specify Color - 4"H	\$79⁹⁹ EA



MAN SHIELD

- 22"W x 26"L x 5"H - 5 lbs.; 4 reinforced handles

1384302	Royal	\$99⁹⁹ EA ★
1384303	Black	\$99⁹⁹ EA ★



PRO SHIELD

- 2 reinforced handles
- 16"W x 42"L x 4"H - 5 lbs.

200234412	Black Only	\$79⁹⁹ EA ★
1393033	Specify Color	\$99⁹⁹ EA

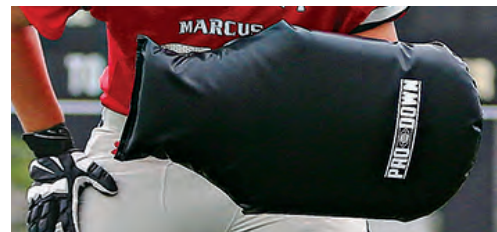

FOREARM SHIVER PADS

- 24" x 11.5" x 3"
- Shock foam pad with nylon-reinforced cover
- Protects hand and forearm area

200232412	Black Only	\$33⁹⁹ EA ★
------------------	------------	-------------------------------



POWER DRIVER INDOOR BLOCKING SLED

The Power Driver is the perfect product for your football field house or weight room. Keep the team's technique sharp while conditioning specifically targeted muscle groups on season or off season. Helps develop quickness, hand placement and strength. Players can strike the Man Pad at the arm pits which are perfectly located at 16" wide, 37" high at a 65 degree angle. Lift the Pivot Arm 14" while driving the 85 lb. Carriage up a 5 degree incline for 60" of travel.

FEATURES:

- 2" x 3" steel tubing frame with Silver & Black Powder Coated Finish
- Carriage glides freely on 6 precision bearing polyurethane wheels with sound deadening bump stops
- Increase resistance by adding up to 135 lbs. to the pivot arm and/or adding up to 360 lbs. to the carriage
- Man Pad is 6" thick urethane foam covered in 18 oz. blue vinyl
- Unit must be anchored to the ground
- Easily removable Man Pad so unit can be used for additional drills

1375101	92"L x 56"W x 51"H - 387 lbs.	\$1,299⁹⁹ EA ★
----------------	-------------------------------	----------------------------------

SHIELD DUMMY COLOR CHOICES: CHOOSE FROM 11 SCHOOL COLORS

NJ State Approved Co-op #65MCECCPS Metuchen/Garden State Apparel Bid Term: 5/9/18 - 5/8/20: Extended to 5/8/21

BLACK*

DARK GREEN

GRAY

KELLY

MAROON

NAVY



DUMMIES & PADS

FOOTBALL



- Double-reinforced 18 oz. vinyl shell
- Durable foam interior

- Black ProDown in stock*
- Other colors ship from Fisher Athletic. Allow 2-3 Wks for delivery



ROUND BLOCKING DUMMY

• 2 reinforced handles

200235001	14"W x 48"L - 13 lbs. - Black Only	\$159 ⁹⁹ EA ★
1393256	14"Wx48"L - 14 lbs. - Specify Color	\$179 ⁹⁹ EA
200235312	13"W x 38"L - 10 lbs. - Black Only	\$129 ⁹⁹ EA ★
1393055	13"W x 38"L - 10 lbs. - Specify Color	\$149 ⁹⁹ EA

HEAVY ROUND BLOCKING DUMMY

• 2 reinforced handles

200235112	14"W x 48"L - 20 lbs. - Black Only	\$179 ⁹⁹ EA ★
1393267	14"W x 48"L - 20 lbs. - Specify Color	\$189 ⁹⁹ EA



SQUARE BLOCKING DUMMY

• 2 reinforced handles

200235012	14"W x 50"L - 15 lbs. - Black Only	\$149 ⁹⁹ EA ★
1393044	14"W x 50"L - 14 lbs. - Specify Color	\$189 ⁹⁹ EA



STEP-OVER DUMMIES

• Handles on ends and bottom

200230812	17"B x 8"H x 51"L - 10 lbs. - Black Only	\$119 ⁹⁹ EA ★
1393279	17"B x 8"H x 48"L - 20 lbs. - Specify Color	\$159 ⁹⁹ EA
200231212	17"B x 12"H x 51"L - 20 lbs. - Black Only	\$159 ⁹⁹ EA ★
1393290	17"B x 12"H x 48"L - 30 lbs. - Specify Color	\$179 ⁹⁹ EA



REPLACEMENT DUMMIES FOR OUTDOOR SLEDS

- Polyurethane foam filling covered with durable 18 oz. vinyl
- Seams are double stitched with heavy-duty nylon thread for added durability
- Cone pad only includes handles to allow for dummy use without sled
- Cone and Man pad in stock in Royal Blue only
- Cone pad dimensions: 48"H x 18" Top Diam x 13" Bottom Diam
- Man Pad dimensions: 48"H x 28"W x 10"D

1296259	Pro Pad - Royal Only	\$399 ⁹⁹ EA ★
1243994	Cone Pad - Royal Only	\$399 ⁹⁹ EA ★

DUE TO DYE LOTS AND NATURAL VARIATIONS, VINYL COLORS MAY VARY SLIGHTLY IF ORDERED AT SEPARATE TIMES.

NJ State Approved Co-op #65MCECCPS Metuchen/Garden State Apparel Bid Term: 5/9/18 - 5/8/20; Extended to 5/8/21

ORANGE

PURPLE

RED

ROYAL

GOLD

PRO-DOWN BLOCKING SLEDS



ATTACHMENT CHAIN



COACHES PLATFORM



Spring Design Licensed From Marty Gilman, Inc.

VARSITY M-SERIES BLOCKING SLEDS

- All steel powder coated frame construction
- Modular frame construction allows for convenient expansion or removal of a man when needed
- Features 52" splits
- Super-Duty flat leaf springs absorb initial shock and recoils with equal force
- Round tubular steel "all surface" skids
- Optional Coaches Platform available
- Comes stock with royal blue Cone or Pro Pad
- Cone Pads available in custom colors: Black, Columbia Blue, Dark Green, Gold, Gray, Kelly Green, Maroon, Navy, Orange, Purple, Scarlet & White (please allow 4 weeks additional lead-time)

1378632	2-Man with Royal Pro Pads	\$1,799 ⁹⁹	EA ★	S&H
1378642	2-Man with Royal Cone Pads	\$1,799 ⁹⁹	EA ★	S&H
1378652	2-Man with Custom Cone Pads	\$1,999 ⁹⁹	EA ★	S&H
1378633	3-Man with Royal Pro Pads	\$2,699 ⁹⁹	EA ★	S&H
1378643	3-Man with Royal Cone Pads	\$2,699 ⁹⁹	EA ★	S&H
1378653	3-Man with Custom Cone Pads	\$2,999 ⁹⁹	EA ★	S&H

1378634	4-Man with Royal Pro Pads	\$3,599 ⁹⁹	EA ★	S&H
1378644	4-Man with Royal Cone Pads	\$3,599 ⁹⁹	EA ★	S&H
1378654	4-Man with Custom Cone Pads	\$3,999 ⁹⁹	EA ★	S&H
1378635	5-Man with Royal Pro Pads	\$4,499 ⁹⁹	EA ★	S&H
1378645	5-Man with Royal Cone Pads	\$4,499 ⁹⁹	EA ★	S&H
1378655	5-Man with Custom Cone Pads	\$4,999 ⁹⁹	EA ★	S&H
1378636	6-Man with Royal Pro Pads	\$5,299 ⁹⁹	EA ★	S&H
1378646	6-Man with Royal Cone Pads	\$5,299 ⁹⁹	EA ★	S&H
1378656	6-Man with Custom Cone Pads	\$5,899 ⁹⁹	EA ★	S&H
1378637	7-Man with Royal Pro Pads	\$5,999 ⁹⁹	EA ★	S&H
1378647	7-Man with Royal Cone Pads	\$5,999 ⁹⁹	EA ★	S&H
1378657	7-Man with Custom Cone Pads	\$6,799 ⁹⁹	EA ★	S&H
1362618	Optional Coaches Platform	\$209 ⁹⁹	EA ★	S&H



M-SERIES 1-MAN SLED

- All steel powder coated frame construction
- Super-duty flat leaf springs absorb shock and bounce back providing maximum recoil
- Tubular steel skids for durability and performance on all field types
- Stock pads available in cone or pro pad design in royal blue
- Cone pads available in custom colors: Black, Columbia Blue, Dark Green, Gold, Grey, Kelly Green, Maroon, Navy, Orange, Purple, Scarlet and White (Please allow 4 weeks additional lead-time for custom colors)

1271522	Royal Pro Pad - 230 lbs.	\$999 ⁹⁹	EA ★	S&H
STACKBL	Royal Cone Pad - 230 lbs.	\$999 ⁹⁹	EA ★	S&H
STACKLE	Custom Color Cone Pad - 230 lbs.	\$1,199 ⁹⁹	EA ★	S&H



YOUTH BLOCKING SLEDS

- All steel powder coated "modular frame construction" allows you to add or remove a man from the sled as desired
- Super-Duty flat leaf springs absorb initial shock and returns it with equal force
- Powder coated tubular steel skids can be used on all field surfaces
- These sleds are ideal for the 11 to 15 year old age group
- Features 42" splits

1362612	2 Man with Royal Pro Pads - 265 lbs.	\$1,399 ⁹⁹	EA ★	S&H
1363502	2 Man with Royal Cone Pads - 265 lbs.	\$1,399 ⁹⁹	EA ★	S&H
1362613	3 Man with Royal Pro Pads - 405 lbs.	\$1,899 ⁹⁹	EA ★	S&H
1363503	3 Man with Royal Cone Pads - 405 lbs.	\$1,899 ⁹⁹	EA ★	S&H
1362615	5 Man with Royal Pro Pads - 690 lbs.	\$2,999 ⁹⁹	EA ★	S&H
1363505	5 Man with Royal Cone Pads - 690 lbs.	\$2,999 ⁹⁹	EA ★	S&H
1362617	7 Man with Royal Pro Pads - 970 lbs.	\$3,999 ⁹⁹	EA ★	S&H
1363507	7 Man with Royal Cone Pads - 970 lbs.	\$3,999 ⁹⁹	EA ★	S&H
1362618	Optional Coaches Platform	\$209 ⁹⁹	EA ★	S&H



BULL SLED

- **Blocking Units:** Sturdy metal pedestal mounted to powder coated steel frame. Torso pad with hand engagement area mounts to the pedestal on a 3" X 3" steel post that telescopes into the fulcrum mechanism. Spring tension can be adjusted through the full range of motion.
- **Modular Construction:** Individual components allow stations to be added as the need arises or budget permits. Start with 1 or 2 Man Sled and easily expand as desired.
- The BULL Sled teaches players to roll their hips to maximize power and drive through opponents. 42" H Pads lock down for drive blocking.
- Please specify pad color: Black, Red, Royal or Gold only.

5 Year Limited Warranty

1271249	Single	\$1,899 ⁹⁹	EA	
1271256	2 Man	\$3,399 ⁹⁹	EA	
1271263	3 Man	\$4,599 ⁹⁹	EA	
1271270	4 Man	\$5,799 ⁹⁹	EA	
1271287	5 Man	\$6,999 ⁹⁹	EA	
1271294	6 Man	\$8,199 ⁹⁹	EA	
1271300	7 Man	\$9,399 ⁹⁹	EA	



FOOTBALL

PASSING MACHINES

FOOTBALL MACHINE

- Football training machine is a snap, pass and kick machine
- Simulates 100 yd passes & punts, 70+ yard kick-offs & 5-15 yard tight spiral snaps at speeds of 70+ MPH
- Solid polyurethane throwing wheels - no air required
- On the passing stand, pivots instantly in any direction, accurately throwing passes, punts and kickoffs
- In the lowered position at ground level and realistic angles, machine snaps ball to any depth in shotgun and pistol formations, extra points and punts
- Light weight cast aluminum throwing wheel guards protect players, coaches, fingers and hands
- Steel-plated frame for strength and weather-resistance

5 Year Limited Warranty

1390108	165 lbs.	\$4,399 ⁹⁹	EA	
---------	----------	-----------------------	----	--



CART FOR JUGS FOOTBALL PASSING MACHINES

- Allows for convenient transport of your JUGS throwing machine
- Pneumatic tires allows for easy relocation without damaging your turf
- Front two wheels swivel 360 degrees for easy maneuverability
- T-bar handle

1376901	32" W x 62" L - 125 lbs.	\$819 ⁹⁹	EA	
---------	--------------------------	---------------------	----	--



FIELD GENERAL FOOTBALL PASSING MACHINE

- Solid steel and cast aluminum construction
- Powered by 110 Volt AC or 1000-watt generator
- Throws footballs 5 - 50 yds and up to 5 sec. hang time
- Throws perfect spiral passes, punts or kicks
- Dial setting speed adjustment
- Unit swivels 360 degrees and includes transport wheel

5 Year Limited Warranty

1276848	94 lbs.	\$2,599 ⁹⁹	EA	
---------	---------	-----------------------	----	--



FOOTBALL PASSING MACHINE

- Solid steel and cast aluminum construction
- Powered by 110 Volt AC or 1000-watt generator
- Throws footballs 5 - 80 yards and up to 7.5 sec. hang time
- Throws perfect spiral passes or punts and end-over-end kicks
- Dial setting speed adjustment
- Unit swivels 360 degrees and includes transport wheel

1159226	127 lbs.	\$2,999 ⁹⁹	EA	
---------	----------	-----------------------	----	--





MULT-PURPOSE EQUIPMENT WAGON

- All steel construction with pneumatic tires
- Use for carrying equipment, water containers, or field storage
- Front, rear, and side panels fold away for easy loading/unloading
- 1400 lb. weight capacity

1291766	11"H (sides) x 24"W x 48"L	\$309 ⁹⁹ EA ★
1334647	Optional Hook Set	\$17 ⁹⁹ SET



FOOTBALL FIELD EQUIPMENT CART

- Heavy duty cart designed to easily transport football sideline equipment
- J-Hooks and strap to carry down marker and chain set
- Steel frame with sturdy expanded metal deck to prevent standing water
- Sized right to carry pylons, sideline markers and goal post pads
- Maneuvers easily with semi-pneumatic casters and pull handle
- Equipped with optional use towing attachment

1378681	47"L x 33"W x 37"H - 120 lbs.	\$599 ⁹⁹ EA ★
----------------	-------------------------------	--------------------------



DAY/NIGHT SIDELINE MARKERS

- Soft, crushable foam core inside durable vinyl cover
- Improved with better visibility for day or night games
- Folding design for flat storage
- Hook and loop fasteners with weighted bottom to maintain upright position
- 15"H X 15"W with 13"H numbers
- 11 piece set includes: 2-G, 2-10, 2-20, 2-30, 2-40, 1-50

1249347	11 Piece Set	\$309 ⁹⁹ SET ★
1249354	2-G, 2-20, 1-40	\$159 ⁹⁹ SET ★



SOLID SIDELINE MARKERS WITH HANDLE

- Vinyl covered foam with weighted bottom
- 15"H x 15"W with 10"H numbers
- 11 piece set includes: 2-G, 2-10, 2-20, 2-30, 2-40, 1-50
- 5 piece set includes: 2-G, 2-20, 1/40

1249361	11 Piece Set	\$259 ⁹⁹ SET ★
1249378	5 Piece Set	\$119 ⁹⁹ SET ★



STACKABLE SIDELINE MARKERS

- 13"H, 3 sided pyramid shaped markers
- Made of tough, flexible vinyl
- Stackable for easy storage
- 5-piece set includes: 2-G's, 2-20's, 1-40
- 11-piece set includes 2/G's, 2/10's, 2/20's, 2/30's, 2/40's, 1/50

1245127	5 Piece Set for Flag Football	\$165 ⁹⁹ SET ★
1245134	11 Piece Set	\$319 ⁹⁹ SET ★



WEIGHTED ANCHORLESS PYLONS

- Stands by itself, no anchor system required
- Bright, fluorescent orange vinyl covered foam with a weighted bottom
- 18"H x 4"W x 4"D - 4 lbs. each

MSWPYLON	\$41 ⁹⁹ SET OF 4 ★
-----------------	-------------------------------



ANCHORED PYLONS

- Safe vinyl covered foam with a 'spring-back' coil anchor system
- Bright, fluorescent orange color
- Set of 4 for 10 yard line
- 18"H x 4"W x 4"D

MSPYLONS	\$69 ⁹⁹ SET OF 4 ★
-----------------	-------------------------------



PYLON AND SIDELINE MARKER BAGS

- Store and protect your sideline markers and pylons
- Web strap wrap around handles for easy transport
- Heavy Duty 600 Denier polyester

1370750	Sideline Marker Bag 28"H x 28"W x 14"D	\$29 ⁹⁹ EA ★
1370751	Pylon Storage Bag 18"H x 18"W x 12"D	\$25 ⁹⁹ EA ★

BUY THE PACKAGE AND SAVE!

DOWN INDICATORS AND CHAIN SETS

- Fully padded poles, indicator boxes, banners and bulls-eyes
- Down indicator is available in 7' 4" padded flip style or 7' 4" padded mechanical style with slide levers for changing down numbers
- 8'H chain sets with "Bulls-eye" design feature a two-piece pole, galvanized steel chain, swivel snap hook, molded ground stops and rubber ends.
- Fully padded banners are available in high visibility solid orange, chevron, or diagonal pattern
- J.V. chain set comes with single-ply solid orange banner



	Down Indicator Only	J.V. Chain Set & Down Indicator	Diagonal Chain Set & Down Indicator	Solid Chain Set & Down Indicator	Chevron Chain Set & Down Indicator
Flip Indicator	A. 1370767 \$189 ⁹⁹ EA ★	1376988 \$349 ⁹⁹ SET ★	FBCOLSET \$369 ⁹⁹ SET ★	1379285 \$399 ⁹⁹ SET ★	1379286 \$419 ⁹⁹ SET ★
BSN SPORTS Pro-Style Indicator	B. FBPROBOX \$394 ⁹⁹ EA ★	1379287 \$519 ⁹⁹ SET ★	1375486 \$539 ⁹⁹ SET ★	FBPROSET \$569 ⁹⁹ SET ★	1375487 \$579 ⁹⁹ SET ★

J.V. Chain Set Only	Diagonal Chain Set Only	Solid Chain Set Only	Chevron Chain Set Only
1370765 \$199 ⁹⁹ SET ★	FBPROCSX \$219 ⁹⁹ SET ★	1370766 \$239 ⁹⁹ SET ★	1371543 \$259 ⁹⁹ SET ★



OFFICIALS JERSEY

- 100% polyester
- Styled with zipper and 1 1/4" black cuff on sleeve end

C58	M-XL	\$29 ⁹⁹ EA ★
C58XXLXX	XXL	\$30 ⁹⁹ EA ★
C58XXXLG	XXXL	\$31 ⁹⁹ EA ★

OFFICIAL'S PENALTY FLAG

- Regulation size 15" x 15" nylon with a weighted center
- Available in yellow only

FBREFFLG	\$8 ⁹⁹ EA ★
-----------------	------------------------



10-YARD REPLACEMENT CHAIN

- Yellow powder coated steel chain
- Compatible with any chain set

MSCHAINS



CHAINSMANS & BOXMANS VESTS

- Water repellent nylon construction with adjustable hook-and-loop closure
- Bright gold with black markings or bright orange with black markings
- Two vests for chain set with black diamonds
- One vest for down box with black stripes

1370749	Yellow/Black	\$39 ⁹⁹ SET ★
1370746	Orange/Black	\$39 ⁹⁹ SET ★



OFFICIALS CHAIN CLIP/YARD MARKER

- 14" Long - Orange Nylon
- Marks yardage from 0 - 50 in 5 yard increments
- End metal clip to fasten to chain



PRO DOWN CHAIN SET CARRY BAG

- Will hold one complete chain set and down indicator
- Heavy-duty 600 Denier polyester construction
- Rugged nylon zipper with wrap around handles and shoulder strap
- Size: 99"L x 17.5"H x 5.25"W

1310351	Black Only	\$89 ⁹⁹ EA ★
----------------	------------	-------------------------



OFFICIALS THROW-DOWN BEAN BAG

- Weighted throw-down bean bag
- Single-sided
- Long-neck design



CROSS-OVER ZONE® TRACK PROTECTOR

- Made with a tough, durable polypropylene non-woven fabric
- Entire edge is vinyl wrapped with internal steel chain weighting, making it wind-proof (No stakes required)
- Easy-to-install temporary cover, resists and cushions against steel-tipped football cleats, yet allows rain to drain through
- Saves modern track materials from damaging cleats and other traffic
- Color: Black with Gold or White edging

1248326	7.5'W x 30'L	\$529 ⁹⁹ EA	
1248333	7.5'W x 40'L	\$639 ⁹⁹ EA	
1248340	7.5'W x 50'L	\$739 ⁹⁹ EA	
1248296	15'W x 30'L	\$729 ⁹⁹ EA	
1248302	15'W x 40'L	\$869 ⁹⁹ EA	
1248319	15'W x 50'L	\$1,049 ⁹⁹ EA	
1248357	Custom Size - 420 sqft Minimum Per Piece	\$2 ⁹⁹ SQ.FT	



BENCH ZONE® SIDELINE TRACK PROTECTOR

Finally, there is a way to easily cover sideline bench areas that include both turf and track surface

- Made with the toughest polypropylene geo-textile fabric
- Entire edge is vinyl wrapped with internal steel chain weighting, making it wind-proof (No stakes required)
- Designed to protect track surface in bench area where the track fits tightly around football field
- Resists and cushions against cleats and other traffic yet allows rain to drain through
- To reduce handling weight and for ease of installation, the longer pieces come in two sections that can be easily joined with Velcro® strips that are double-stitched along the entire length of each section's overlapping chain-free center edges
- 75'L comes in 1 section while 100', 125' and 150' come in 2 sections
- Color: Black with Gold or White edging

1239751	15'W x 75'L	\$1,299 ⁹⁹ EA	
1239768	15'W x 100'L	\$1,499 ⁹⁹ EA	
1239775	15'W x 125'L	\$1,699 ⁹⁹ EA	
1239782	15'W x 150'L	\$1,899 ⁹⁹ EA	
1245905	Custom Size - 801 sqft Minimum Per Piece	\$1 ⁹⁹ SQ.FT	



HUDDLE ZONE® SPECIAL TEAMS MAT

ELIMINATES COSTLY PENALTIES & SAVES TIMEOUTS

- Cleat-proof industrial matrix fabric with 3' squares for each player, plus front section for captain and coach
- Entire edge is vinyl wrapped with internal steel chain weighting, making it wind-proof (No stakes required)
- 3" W gold, screened-on stripes on light gray fabric, the same fabric used for Bench Zone™ turf mats
- Allows offense, defense and special teams to organize and call plays on the sideline before entering the game
- Folds easily for storage and travel to away games

1248364	9'W x 15'L - 46 lbs.	\$439 ⁹⁹ EA
---------	----------------------	------------------------

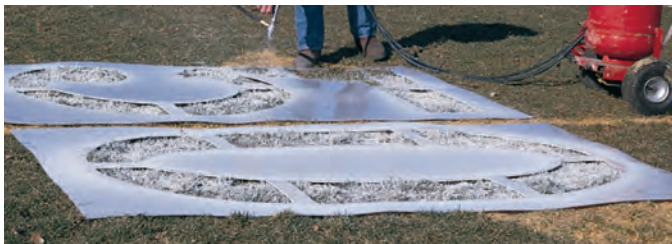

FOOTBALL FIELD STENCIL KIT

- Kit contains 0-5, G and directional arrow
- Cut from 1/8" plastic - ultimate durability
- Keeps your field clearly and attractively marked

1385374	\$899 ⁹⁹ SET
---------	-------------------------

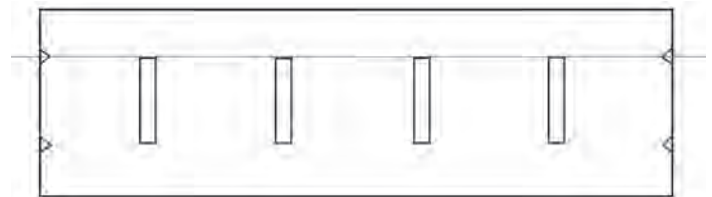

FOOTBALL HASH MARK GUIDE

- Made from tough Coroplast material
- Easy to use - will fit between yard lines
- Paint through template
- V notches for string alignment

1162653	\$279 ⁹⁹ EA
---------	------------------------

Bid #ESCNJ 17/18-31

Educational Services Commission of New Jersey

Athletic Equipment & Supplies

BENCH ZONE® SIDELINE TURF PROTECTOR

HELPS PROTECT PLAYERS & GROUND CREW AGAINST MRSA.

- Cleats cannot penetrate, but rain, sports drinks, sweat, etc. drain through and are not absorbed and retained like in other mats. Simply hose off to clean and store.
- Fabric is super tough VIPOL® Matrix material that is non-absorbent and very durable. Air and sunlight can also penetrate so this bench tarp may be left down for longer periods without damaging turf.
- All edges are folded, internally reinforced and double-stitched.
- Grommets installed every 18".
- Packs of 6" low profile stakes sold separately.
- Available in 20 colors!
- Now used by hundreds of high schools plus dozens of NCAA and NFL teams.

2 Year Limited Warranty

1239669	15'W x 50'L - Specify Color	\$1,149 ⁹⁹	EA	S&H
1239676	15'W x 75'L - Specify Color	\$1,459 ⁹⁹	EA	S&H
1239683	15'W x 100'L - Specify Color	\$1,799 ⁹⁹	EA	S&H
1239690	15'W x 125'L - Specify Color	\$1,999 ⁹⁹	EA	S&H
1239706	15'W x 150'L - Specify Color	\$2,199 ⁹⁹	EA	S&H
1269086	Custom Size - 420 sqft Minimum (Specify Color)	\$1 ⁹⁹	SQ.FT	S&H

BENCH ZONE® GET BACK LINE

- Save your sideline from penalties

1271232	8" W - Specify Color	\$489 ⁹⁹	EA
---------	----------------------	---------------------	----

BENCH ZONE® ANCHOR STAKES

1239713	6" - 30/Pack	\$32 ⁹⁹	EA
1239720	6" - 115/Pack	\$76 ⁹⁹	EA



FOOTBALL

Sideline Turf Protectors Available in:



CHROMA-BOND® IMPRINTING

- Double coated multicolor imprinting that does not fade, flake or scuff like other spray on or digital imprinting
- Images are sharp, vivid and outlast any other type of imprinting
- School colors can be matched

2 Color Logo & Lettering on a 3rd Color Background

1297782	Overall Size up to 4'H x 50'L	\$1,899 ⁹⁹	EA
1297799	Overall Size up to 3'H x 30'L	\$1,599 ⁹⁹	EA

1, 2 or 3 Color Print

1380610	1 Color up to 25 sq. ft.	\$599 ⁹⁹	EA
1380611	1 Color 26-50 sq. ft.	\$749 ⁹⁹	EA
1380613	2 Color up to 25 sq. ft.	\$699 ⁹⁹	EA
1380614	2 Color 26-50 sq. ft.	\$849 ⁹⁹	EA
1380616	3 Color up to 25 sq. ft.	\$799 ⁹⁹	EA
1380617	3 Color 26-51 sq. ft.	\$949 ⁹⁹	EA

1 or 2 Color Letters only

1298154	Up to 24" T	\$57 ⁹⁹	EA
1298161	Up to 36" Tall	\$64 ⁹⁹	EA
1298178	Up to 48" Tall	\$79 ⁹⁹	EA
1298185	Up to 60" Tall	\$93 ⁹⁹	EA
1298192	Up to 72" Tall	\$114 ⁹⁹	EA
1298208	Up to 84" Tall	\$124 ⁹⁹	EA



BENCH ZONE® PROTECTIVE TURF MAT

- Made of tough 60mm polypropylene non-woven breathable fabric
- Color is Light Gray and comes either with or without grommets
- Grommets are spaced at 3' intervals
- Designed for plastic or rubber cleated footwear
- Stakes recommended (Sold separately - See above)

1323634	15'W x 50'L - No Grommets	\$319 ⁹⁹	EA
1323641	15'W x 50'L - With Grommets	\$429 ⁹⁹	EA
1323658	15'W x 75'L - No Grommets	\$469 ⁹⁹	EA
1323665	15'W x 75'L - With Grommets	\$609 ⁹⁹	EA
1323672	15'W x 100'L - No Grommets	\$639 ⁹⁹	EA
1323689	15'W x 100'L - With Grommets	\$769 ⁹⁹	EA
1323696	15'W x 125'L - No Grommets	\$799 ⁹⁹	EA
1323702	15'W x 125'L - With Grommets	\$949 ⁹⁹	EA
1323719	15'W x 150'L - No Grommets	\$979 ⁹⁹	EA
1323726	15'W x 150'L - With Grommets	\$1,129 ⁹⁹	EA





ALUMINUM HIGH SCHOOL FOOTBALL GOALPOSTS

- 6 5/8" O.D. schedule 40 aluminum gooseneck and crossbar with 4" O.D. aluminum uprights
- Choose from either 6' 6" or 8' offset post and 20' or 30' uprights
- All parts are powder coated
- Ground sleeves, mounting plates and post pads sold separately
- Specify Yellow or White powder coated finish
- **Actual Freight charges apply to 30' Uprights**

2 Year Limited Warranty

High School Crossbar - 23' 4"

1271072	6'6" Offset - 20' Uprights	\$9,199 ⁹⁹ PR	
1271089	8' Offset - 20' Uprights	\$9,199 ⁹⁹ PR	
1271096	6'6" Offset - 30' Uprights	\$9,599 ⁹⁹ PR	
1271102	8' Offset - 30' Uprights	\$9,599 ⁹⁹ PR	

Collegiate Crossbar - 18' 6"

1271119	6'6" Offset - 20' Uprights	\$8,499 ⁹⁹ PR	
1271126	8' Offset - 20' Uprights	\$8,499 ⁹⁹ PR	
1271133	6'6" Offset - 30' Uprights	\$9,299 ⁹⁹ PR	
1271140	8' Offset - 30' Uprights	\$9,299 ⁹⁹ PR	

6 5/8" OD POST PAD

- 6'H round post pad constructed of 4" thick foam encased in 18oz vinyl
- Specify hook and loop or zipper closure
- Color options: Black, Grey, Kelly Green, Maroon, Orange, Royal Blue, Scarlet, White, Yellow

1271218	Specify Pad Color	\$299 ⁹⁹ EA
1271225	Specify Lettering Color	\$109 ⁹⁹ EA

ALUMINUM FOOTBALL GOALPOST ACCESSORIES

2 Year Limited Warranty

1271157	Optional Ground Sleeve	\$699 ⁹⁹ EA	
1271164	Access Frame	\$289 ⁹⁹ EA	
1271171	2 Piece Wood Lid with Hole	\$199 ⁹⁹ EA	
1271188	2 Piece Turf/Wood Lid with Hole	\$169 ⁹⁹ EA	
1271195	Solid Wood Lid	\$69 ⁹⁹ EA	
1271201	Solid Turf Covered Wood Lid	\$169 ⁹⁹ EA	



PROTECTIVE POST PADS

- 6'H post pad constructed of 4" thick high-density urethane foam encased in 18 oz. vinyl
- Available in two sizes with zipper or hook-and-loop closure designs
- Please specify color. Red and Blue in stock.
- Allow 4 to 6 weeks for colors other than Red or Blue
- Optional one-color or two-color lettering available at additional cost

1362696	Hook & Loop up to 4 1/2" O.D. Post	\$299 ⁹⁹ EA
1366530	Hook & Loop 5" - 6 1/2" O.D. Post	\$329 ⁹⁹ EA ★

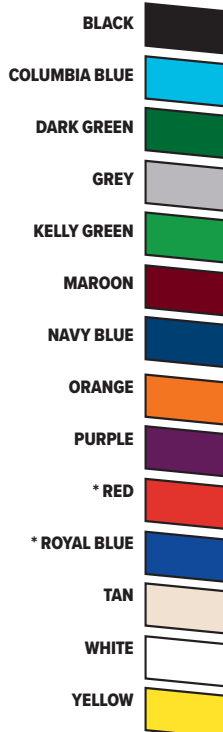

OPTIONAL LETTERING FOR POST PADS

- Add up to (8) 8" letters to your post pads
- Letters will be one-color or two-color block style
- Please allow 4 - 6 weeks production time

1362695	One-Color	\$229 ⁹⁹ EA
1376909	Two-Color	\$229 ⁹⁹ EA



ROLL-A-WAY FOOTBALL GOAL POSTS

- High school size practice goal post
- Constructed of 2" O.D. galvanized steel tubing
- Easy assembly with heavy-gauge galvanized fittings
- Transport wheels included

1282542	440 lbs.	\$3,299 ⁹⁹ PR	
---------	----------	--------------------------	--

OFFICIAL HIGH SCHOOL GOOSENECK GOALPOSTS

- Heavy-duty 4 1/2" O.D. galvanized steel gooseneck with 5' offset
- Heavy-duty 4" O.D. galvanized steel crossbar
- High School 23' 4" Crossbar
- 2 3/8" O.D. aluminum uprights
- Includes 4 wind direction flags
- All parts are powder coated
- Optional ground sleeves recommended
- 30' uprights are UIL recommended

High School Crossbar - 23' 4"

1240450	White - 20' Uprights	\$3,699 ⁹⁹	PR ★	
1240467	Yellow - 20' Uprights	\$3,699 ⁹⁹	PR ★	
1309249	White - 30' Uprights	\$3,999 ⁹⁹	PR ★	
1309256	Yellow - 30' Uprights	\$3,999 ⁹⁹	PR ★	

Goalpost Accessories

1265248	Optional Ground Sleeves	\$499 ⁹⁹	PR ★	
1197747DS	Wind Direction Flags	\$15 ⁹⁹	4/SET	

NOW EASIER INSTALLATION

New adjustable elbow & aluminum uprights on all models make for precise vertical alignment!

ACTUAL FREIGHT CHARGES APPLY ON 30' UPRIGHTS.



CLASSIC "H" SHAPE STEEL GOAL POST

- Constructed with 3.5" heavy-wall, flo-coated, galvanized steel and redesigned for easy permanent installation
- Official high school dimensions (23' 4"W x 10'H crossbar with 20'uprights)
- Includes wind direction flags and post caps to keep rain out of uprights
- Optional ground sleeves not required for installation

STFBGPHS	Pair of Goals	\$1,899 ⁹⁹	PR ★	
STHSFBGP	Single Goal Only	\$999 ⁹⁹	EA ★	
STHSFBGS	Optional Ground Sleeves	\$199 ⁹⁹	PR ★	



FOOTBALL/SOCCER COMBO GOAL

- Meets High School soccer and football regulations
- 10'H football uprights are constructed of 2" square aluminum tubing
- Width of uprights can be adjusted for H.S. (23'4") or Collegiate (18'6") play or removed for soccer play
- Soccer goal size - 8'H x 24'W x 3'D
- Soccer post are constructed of 11 gauge 2" x 4" steel tubing
- Crossbars are constructed of 14 gauge 2" x 4" steel tubing
- Two-piece engineered crossbar for increased ease of shipping and installation
- Euro style backstays are constructed of 14 gauge - 1.5" steel tubing
- Extremely corrosion resistant galvanized and white powder coated finish
- Goals include backstays, 4mm soccer nets, net fasteners and ground stakes
- Optional Ground Sleeves available for semi-permanent installation

SGFBCOM	1 Pair of Goals - Includes Nets	\$2,899 ⁹⁹	PR ★	
1307769	4mm - Replacement Net	\$249 ⁹⁹	PR ★	
1308082	Ground Sleeves - 4/Set	\$179 ⁹⁹	SET ★	

NJ State Approved Co-op #65MCESCPS Metuchen/Garden State AppareBid Term: 5/9/18 - 5/8/20: Extended to 5/8/21



dynamic
protection
performance
technology
RAZOR
design
innovation
evolution
cutting edge

BY **GEAR PRO-TEC**



INJECTION MOLDED COMPONENTS

All plastic components (Arches, Epaulets, Caps, Buckles) are injection molded polypropylene with impact modifiers for superior strength and structural integrity.

SAS-TEC FOAM IMPACT ZONE PROTECTION

SAS-TEC Visco Elastic Foam system with intelligent impact molecules is thin, lightweight and flexible with superior impact absorption properties.



PAD-LOC BUCKLE SYSTEM

Industry first belt attachment system, features injection molded plastic buckle/housing with automotive grade web strap and padded, protective buckle slider pad. The "tongue and groove" buckles lock into place in the recessed housing for a flush mount and no grab points.



TACTICAL ENERGY DISPERSION SYSTEM

Patented Z-Cool (#7,168,104) high impact perforated, inner poly arch design is sandwiched between dual layers of perforated EVA and Closed Cell Foams. This system combines for tactical impact energy dispersion and moisture management properties.

DYNAMIC R.O.M. HINGE



12°



The independent exterior arches are structurally secured to the internal poly arches at 2 points, front and rear. When combined with the stretch zone fabric, the arches hinge upward, creating a full 12° more Range of Motion.

RZ7 SKILL

- Slim profile with shorter caps for increased mobility and unrestricted arm movement for the most flexibility
- Average weight - 4.55 lbs. (size large)
- Patent Pending

1388367 Specify Size (SM - 2XL) \$349.⁹⁹ EA ★



RZ15 MULTI-POSITION

- Wider side cut, extended cap and protective deltoid pad for the most coverage and greatest protection in the RAZOR line up
- Average weight - 4.85 lbs. (size XL)
- Patent Pending

1388373 Specify Size (SM - 3XL) \$349.⁹⁹ EA ★



RZ55 OL/DL

- Extremely narrow side cut for the smallest surface area and generous neck opening for freedom of movement gives the big guys what they need for performance in the trenches
- Molded foam caps for reduced weight and snug fit
- Average weight - 4.35 lbs. (size XL)
- Patent Pending

1388380 Specify Size (MD - 3XL) \$349.⁹⁹ EA ★



Size	SM	MD	LG	XL	2XL	3XL
Shoulder	16"-17"	17"-18"	18"-19"	19"-20"	20"-21"	21"-22"
Chest	36"-38"	38"-40"	40"-42"	42"-44"	44"-46"	46"-48"

RAZOR BACK PLATE

- Features Compressed HEX Foam side panels with a SAS-TEC foam spine insert and corrugated exterior shell for maximum protection
- Universal T-nut and screw attachment fits all Razor and Z-Cool shoulder pads as well as most competitor's shoulder pads

1388468 Large - 12" x 7" \$34.⁹⁹ EA ★
1390963 Small - 9.5" x 6" \$29.⁹⁹ EA ★





- **SUPERIOR IMPACT ABSORPTION**
- **ANTI-MICROBIAL ARCH FABRIC**
- **COMPLETELY DRY IN 2-3 HOURS**

The GEAR Pro-Tec Z-Cool® pads provide Ultra-Light Protection that's lighter than traditional pads. Our patented moisture transfer technology provides unsurpassed cooling & superior performance.

TECHNOLOGY

HOW Z-COOL® WORKS

1. ACTIVE AIR CIRCULATION:

3-D Air Flow Brock® Foam allows air to circulate through the pad in three dimensions. As sweat coats the surface area of the waterproof foam beads, the airflow actively accelerates evaporation which is the key to body temperature cooling and post-game drying time.

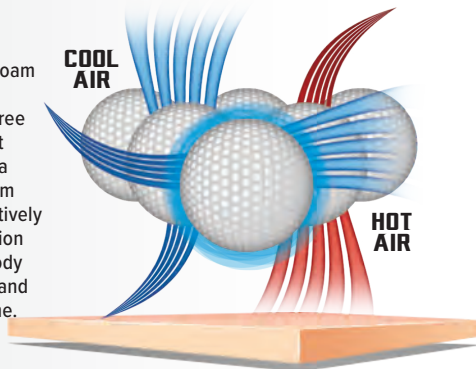

2. IMPACT ENERGY DISPERSION:

Z-Cool® shoulder pads feature Brock® Foam giving them an advantage over the standard open cell foam. Upon impact, each bead in the Brock Foam padding dissipates and redistributes energy waves to the connected adjacent beads.



3. ENHANCED PERFORMANCE:

The benefits of Z-Cool® technology provide athletes with an extra edge on the competition. A perfect combination of materials and engineering to cool the athlete's body by wicking away perspiration and protecting athletes with superior impact dispersion. An ultra-light design that allows athletes at all levels to perform at their very best... in the very best.

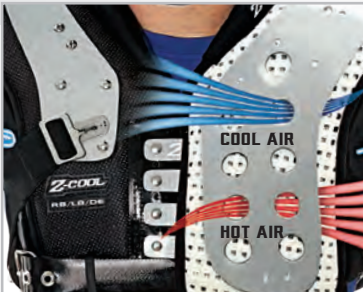

AC notch-out with cradle pad provides Acromioclavicular joint protection. No direct pressure on AC joint.

Adjustable cap system follows arm and shoulder movement allowing for full range of motion and additional protection.



Adjustable and removable waterproof Air-Release® clavicle pads provide a customized fit for maximum comfort and safety.



FOOTBALL

PADS FEATURE:

- Z-Cool® Moisture Transfer System: Patent #7,168,104
- Moisture Wicking Anti-Microbial Interior Fabric
- AC Notch-Out With Cradle Pad
- Adjustable Clavicle Pad System
- Adjustable Cap Pad
- Z-Cool® Plastic Inner Arch Design: Patent #7,168,104
- NEW 1.5" Belts With Non-Cut Buckles: Patent #D543,488
- Pro-Loc Epaulet Design
- Rigid Plastic Sternum Protection

QB/DB/WR

- Flat pad design for low profile with all of the features needed to provide protection and improved mobility required for all skill positions
- Extended flexible arches for superior speed and mobility that are rigid and durable enough to handle the big hits
- Lightweight design with extended arch protection features fixed cap pads, making this a good choice for read option quarterbacks, wide receivers and defensive backs.

1375236 Specify Size (XS - XL) \$229.99 EA ★



QB/WR/DB PRO SELECT

- Our lightest and most flexible pad for all skill positions
- Low profile neck design for increased range of motion
- Shorter outside poly arch plates for maximum speed and mobility
- Floating cap pads and streamlined arches offer ultimate arm mobility while still providing great protection

1375237 Specify Size (XS - 2XL) \$229.99 EA ★



RB/LB/DE

- Combines all the features of a heavy hitting pad while maintaining ideal protection and performance
- This is the ideal multi-position pad
- **NEW** Extended rear arches for greater protection

1375238 Specify Size (SM - 2XL) \$229.99 EA ★



OL/TE/DE

- Advanced technology provides excellent impact absorption, ideal body fit and maximum freedom of movement
- This pad offers the best protection for all aspects of the game
- Wider front and back arch coverage designed for bigger players needing maximum protection on impact

1375239 Specify Size (SM - 3XL) \$229.99 EA ★

OL/OL PRO SELECT

- Without question the lightest weight lineman pad in the game
- Deep, open neck design offers greater range of motion and unrestricted lateral head movement.
- Super streamlined arch cut delivers unsurpassed shoulder and arm mobility

1375240 Specify Size (MD - 4XL) \$229.99 EA ★

SIZE	XSM	SM	MD	LG	XL	2XL	3XL	4XL	5XL	6XL
SHOULDER	33-36"	36-38"	38-40"	40-42"	42-44"	44-46"	46-48"	48-50"	50-52"	52-54"
CHEST	34"-36"	36"-38"	38"-40"	40"-42"	42"-44"	44"-46"	46"-48"	48"-50"	50"-52"	52"-54"

New Jersey State Approved Co-op #65MCECCPS Metuchen/Garden State Apparel Bid Term: 5/9/18 - 5/8/20. Extended to 5/8/21



SIZE	SM	MD	LG	XL	2XL	3XL	4XL	5XL
SHOULDER	16"-17"	17"-18"	18"-19"	19"-20"	20"-21"	21"-22"	22"-23"	23"-24"
CHEST	36"-38"	38"-40"	40"-42"	42"-44"	44"-46"	46"-48"	48"-50"	50"-52"



X-16F QB/WR/DB

- Lightweight flat pad design for low profile and greater mobility
- Includes built-in back plate.

1375241 Specify Size (SM - XL) \$159.99 EA ★



X-19F QB/DB/RB/WR

- Double arch plastic over shoulders for extra protection
- Extended arches front and back for exceptional coverage

1375242 Specify Size (MD - 2XL) \$159.99 EA ★



X-27F RB/LB/TE

- Flat pad design provides optimum combination of protection and mobility for many positions
- Short front arch for extended range of motion and extended rear arch for added protection
- The most versatile pad in the X2 Air line

1375243 Specify Size (SM - 2XL) \$159.99 EA ★



X-S0BF® OL/DL/DE/TE

- Pro-Loc Epaulets with 180 degree arms up motion and restricted down motion US Registration #2,034,235
- Double hook-up: elastic strap – top, grommated belt – bottom

1375244 Specify Size (MD - 5XL) \$159.99 EA ★



- All positions - Varsity and Junior Varsity
- Moisture Management Pro-Tec Energy Foam System
- Flat pad design for low profile
- Vented arches for increased air circulation and better cooling
- Antimicrobial arch fabric reduces odor
- Built-in clavicle channels

1375245 Specify Size (SM - 2XL) \$104.99 EA ★

SIZE	SM	MD	LG	XL	2XL
SHOULDER	16"-17"	17"-18"	18"-19"	19"-20"	20"-21"



- Z-Cool® Moisture Transfer System Patent #7,168,104
- Moisture Wicking Anti-Microbial Interior Fabric
- AC Notch-Out With Cradle Pad
- Adjustable Clavicle Pad System
- Adjustable Cap Pad
- Z-Cool® Plastic Inner Arch Design Patent #7,168,104
- New 1.5" Belts With Non-Cut Buckles, Patent #D543,488
- Pro-Loc Epaulet Design
- Rigid Plastic Sternum Protection

1375246 Specify Size (XS - 3XL) \$104.99 EA ★

SIZE	XSM	SM	MD	LG	XL	2XL	3XL
SHOULDER	12"-13"	13"-14"	14"-15"	15"-16"	16"-17"	17"-18"	18"-19"
WEIGHT	40-65 lbs.	60-80 lbs.	75-100 lbs.	95-120 lbs.	115-140 lbs.	135-160 lbs.	155-180 lbs.



FOOTBALL



X2 AIR® J.V.-F

- Low profile flat pad construction with vented arch plastic
- Perforated arch foam system allows for quick drying
- Front lock stabilizer for sternum protection
- Now featuring 1.25" belts with non-cut buckles

1377129 Specify Size (XS - 3XL) \$59.99 EA ★

SIZE	XSM	SM	MD	LG	XL	2XL	3XL
SHOULDER	12"-13"	13"-14"	14"-15"	15"-16"	16"-17"	17"-18"	18"-19"
WEIGHT	30-45 lbs.	40-60 lbs.	60-80 lbs.	75-100 lbs.	95-120 lbs.	115-140 lbs.	135-160 lbs.



AIR TECH® JR.

- Flat pad design with Pro-Loc epaulets for arms up freedom US Registration #2,034,235
- Perforated moisture management foam
- Heavy-Duty mesh fabric
- Non-stretch underarm straps

1377130 Specify Size (3XSM - XL) \$44.99 EA ★

SIZE	3XSM	2XSM	XSM	SM	MD	LG	XL
SHOULDER	9"-10"	10"-11"	11"-12"	12"-13"	13"-14"	14"-15"	15"-16"
WEIGHT	30-45 lbs.	40-65 lbs.	60-80 lbs.	75-100 lbs.	95-120 lbs.	115-140 lbs.	135-160 lbs.



INTIMIDATOR® JR.

- Flat pad construction
- Smooth Epaulets
- Non-stretch underarm straps

1377131 Specify Size (3XSM - XL) \$39.99 EA ★

SIZE	3XSM	2XSM	XSM	SM	MD	LG	XL
SHOULDER	9"-10"	10"-11"	11"-12"	12"-13"	13"-14"	14"-15"	15"-16"
WEIGHT	30-45 lbs.	40-65 lbs.	60-80 lbs.	75-100 lbs.	95-120 lbs.	115-140 lbs.	135-160 lbs.



GEAR PRO-TEC ACCESSORIES



KNEE PADS

- Air flow and evaporative cooling system
- Sold in pairs

1388428	3" ROUND	\$5.99 PR ★
1312522	XS 4" L x 3" W	\$6.99 PR ★
1312515	S 5" L x 4" W	\$7.99 PR ★
1312508	M 5.5" L x 4.5" W	\$8.99 PR ★



Z-COOL® THIGH GUARDS

- Air flow and evaporative cooling system
- Sold in pairs

1312706	S 7" L x 5" W	\$13.99 PR ★
1312690	M 8" L x 6" W	\$15.99 PR ★



BACK PLATE

- Air flow foam evaporative cooling system
- Lightweight reinforced polycarbonate protective plate
- NEW screw and T-nut attachment system fits all models of GEAR Pro-Tec shoulder pads as well as most competitors (does not fit Z-Cool OL/DL Pro Select, DL/TE/DE and X2 Air X-16 pads)

1317350	Varsity	\$24.99 EA ★
1312379	NJ State Approved Co-op #65	\$19.99 EA ★



RIB COMBO PROTECTOR

- Air flow foam evaporative cooling system
- Lightweight reinforced polycarbonate protective plate
- NEW Screw & T-Nut attachment system designed to fit all models of Gear Pro-Tec shoulder pads
- Hook and loop front closure

1312584	S (34"-38")	\$48.99 EA ★
1312577	M (40"-44")	\$48.99 EA ★
1312560	L (46"+)	\$48.99 EA ★
1317336	Youth M (26"-30")	\$41.99 EA ★
1317348	Youth L (30"-34")	\$41.99 EA ★



WALK THRU AND INJURY VEST

- Air flow foam evaporative cooling system
- Lightweight protection

1317299	S (36"-38")	\$49.99 EA ★
1317305	M (38"-42")	\$49.99 EA ★
1312621	L (44"-46")	\$49.99 EA ★
1312645	XL (46"-48")	\$49.99 EA ★
1312591	2XL (48"-52")	\$49.99 EA ★
1312607	3XL (52"-56")	\$49.99 EA ★
1312614	4XL (56"+)	\$49.99 EA ★



EQUIPMENT BAG

- 32" x 13" x 16"
- Separate compartments for shoulder pads and helmet

1312836	\$30.99 EA ★
----------------	--------------



NECK ROLL

- One size fits all
- Foam filled nylon fabric
- Attaches with screws and t-nuts

1317312	Varsity	\$23.99 EA ★
1317329	Youth	\$16.99 EA ★



REPLACEMENT CAP PAD

- Sold in pairs, Patent #7,168,104

1317374	Z-COOL	\$13.99 PR ★
1363686	X2 AIR	\$13.99 PR ★



AIR-RELEASE® CLAVICLE PADS

- Waterproof layered foam pads with patented Air-Release® technology (Patent #5,701,611)
- Sold in packs of 6

1312409	1" Z-COOL Pattern	\$19.99 PACK ★
1312423	1/2" Z-COOL JV - Black Trim	\$19.99 PACK ★



Bid #ESC/NJ 17/18-31

Educational Services Commission of New Jersey

Athletic Equipment & Supplies



GIRDLES

Compression garments are scientifically proven to improve performance.

FOOTBALL



COMP PRO YOUTH 5-PAD

- 78% nylon, 22% Spandex
- Moisture wicking hip, tail and thigh pads built-in
- 1" waistband for comfortable fit
- Cup pocket standard
- Includes antimicrobial treatment

1364282 Youth S-L \$24.99 EA ★

S-PAD YOUTH	1364283	1364284	1364285
SIZE	SM	MD	LG
WAIST	20"-22"	24"-26"	28"-30"

NEW!

EDGE PRO 5-PAD GIROLE

- Cutting EDGE performance and protection
- The "Power Flow" channels in the HDPE Polymer thigh plate provide ventilation and also disperse impact energy to the EVA Foam padding more efficiently than a solid hard plate
- Moisture-wicking technology in the Poly Spandex fabric lifts sweat to accelerate evaporation and cooling
- Poly Spandex mesh panels enhance ventilation to keep your core body temperature consistent and cool
- Compression fabric contours to your body for optimal fit and full range of motion
- Flat seam design diminishes irritation during movements for constant comfort and the 2" HD waistband provides superior fit
- Includes anti-microbial treatment to reduce odor causing bacteria



1395519 Adult S-3XL \$44.99 EA ★

S-PAD	1395520	1395521	1395522	1395523	1395524	1395525
SIZE	SM	MD	LG	XL	2XL	3XL
WAIST	26"-28"	30"-32"	34"-36"	38"-40"	42"-44"	44"-46"



737 ADULT HEX THUDD SHORT

Designed to adjust to your every move for continuous protection at hips, tailbone and thighs. Compression technology supports large muscles to help reduce pulls and fatigue. Includes cup pocket.

Color Options: **Black, Charcoal, Grey, White**
Size: **SML, MED, LRG, XLG, 2XL.**

1378139 S-2XL \$54.99 EA

PRO HEX PAD 5-POCKET

Features compression girdle with Hex Pads™ protecting hip/tail bones. Includes pockets for thigh pads. Moisture management technology that stretches and protects. Provides relief from chafing and skin irritation.

Color Options: **Grey, White**
Size: **SML, MED, LRG, XLG, XXL, 3XL.**

1416823 Adult S-3XL \$41.99 EA



NEW!

5-PAD INTERGRATED GIRDL

- 85% polyester/15% spandex compression
- Hip/tail pads made of open hole technology to reduce weight
- Thigh pads mad with internal plastic pad to increase protection

Color Options: **White**

AA695PGY Youth S-3XL \$22.99 EA
AA695PG Adult S-4XL \$22.99 EA



INTEGRATED UPPER BODY PROTECTION

Designed with five pads bonded, to be worn with or without shoulder pads. Pads at shoulders, middle back, and ribs. Protective product is lightweight, breathable, and flexible.

Color Options: **CHAR/LIM**
Size: **SML, MED, LRG, XLG, 2XL, 3XL, 4XL.**

AABSPT Adult S-4XL \$36.99 EA



ULTRA-LITE PADS



ULTRA LITE 3-PIECE HIP PADS

• High density ultra-lite foam reinforced with plastic

FBULHP3A	Adult	\$11 ⁹⁹ SET ★
FBULHP3I	Intermediate	\$9 ⁹⁹ SET ★
FBULHP3Y	Youth	\$7 ⁹⁹ SET ★

ULTRA LITE TAIL PADS

• High Density ultra-lite foam reinforced with plastic (7" L)

FBTPS	Slotted	\$3 ⁹⁹ EA ★
FBTPSNAP	Snaps	\$4 ⁴⁹ EA ★



ULTRA-LITE KNEE PADS

• High density ultra-lite foam

FBULKPA	8.25" Adult	\$5 ⁹⁹ PR ★
FBULKPI	7.5" Intermediate	\$5 ⁴⁹ PR ★
FBULKPY	7" Youth	\$4 ⁹⁹ PR ★



ULTRA-LITE THIGH PADS

• High density ultra-lite foam with plastic impact plate

FBULTPA	9" Adult	\$11 ⁹⁹ PR ★
FBULTPI	8" Intermediate	\$10 ⁹⁹ PR ★
FBULTPY	7" Youth	\$9 ⁹⁹ PR ★



YOUTH 7PC ULTRA LITE PAD SET

• High density ultra-lite foam reinforced with plastic

FBUL7YSS	Sliding Snaps	\$17 ⁹⁹ SET ★
FBUL7YSLP	Slotted	\$16 ⁹⁹ SET ★

PRO DOWN

FOOTBALL

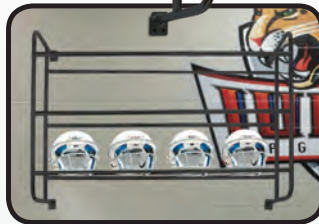

WALL MOUNT HELMET RACK

- Black powder coated 1" steel tubing construction
- Easy to install with 4 screws (not included)
- Will hold up to 18 balls on 3 levels
- Designed to hold football, baseball or lacrosse helmets

1197739

40"H x 60"W x 15"D - 18 lbs.

\$139⁹⁹ EA ★



4-STACK SHOULDER PAD RACK

- Base with rectangular channel design increases strength and stability
- 4 heavy duty swivel casters for easy movement
- Holds up to 60-80 pads (Depending on pad size)

1378670

68"H x 24"W x 60"L - 65 lbs

\$319⁹⁹ EA ★



STORAGE BAG

FOOTBALL HELMET CART

- Constructed of 1" O.D. black powder coated steel tubing
- Heavy duty urethane swivel wheels - 2 with brakes
- 5 welded shelves make for easy assembly
- Will hold 50 football helmets with masks (can also be used for lacrosse helmets, batting helmets, basketball, volleyballs, etc.)
- Fits through standard doorways
- 64"H x 24"W x 61"L - 61 lbs.

1378673

\$299⁹⁹ EA ★

SNBCNET



COMBO HELMET/SHOULDER PAD RACK

- Rigid base design increases strength and stability
- 4 heavy duty swivel casters for easy movement
- Holds up to 30 Shoulder Pads and 32 Helmets

1378672

68"H x 24"W x 30"L - 55 lbs.

\$339⁹⁹ EA ★

SHOULDER PAD HARDWARE



1" Metal T-Hook

FBTH100XPK

\$25⁹⁹ PACK OF 50



1-1/2" Metal T-Hook

FBTH150XPK

\$29⁹⁹ PACK OF 50



1-1/2" Swivel T-Hook

FBSTH150PK

\$47⁹⁹ PACK OF 50



T-HOOK W/BLACK ELASTIC STRAP

- 20" long heavy duty elastic strap in black
- Attached metal T-Hook
- Sold in pairs only

1384277

1" Hook & Strap **\$8⁹⁹** PR

1384278

1.5" Hook & Strap **\$8⁹⁹** PR

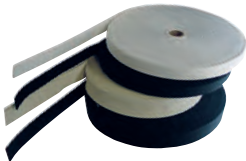

SHOULDER PAD ELASTIC

- Highest quality heavy duty elastic (25 yards p/roll)

FBRE150B

1 1/2" Black **\$51⁹⁹** ROLL

FBRE100B

1" Black **\$35⁹⁹** ROLL

FBRE100W

1" White **\$29⁹⁹** ROLL



SHOULDER PAD LACES

- 40" braided round nylon that is tough and durable. Sold by the gross.

FBSP36B

Black **\$35⁹⁹** GROSS

FBSP36X

White **\$27⁹⁹** GROSS

HELMET HARDWARE



FOOTBALL HELMET PUMP

- Used to inflate and deflate football helmets with air bladders
- Features release valve
- Short needle included

1384319

\$12⁹⁹ EA ★



FOOTBALL HELMET PUMP

- Engineered specifically to inflate and deflate Football helmets. Includes needle.

1066395

\$17⁹⁹ EA



FACEMASK HARDWARE

- Includes all clips, t-nuts and screws needed to attach one wire football facemask to football helmet

1040661

\$6⁹⁹ SET



SIDELINE SIDELINE HARDWARE KIT

- 100 S/S medium t-nuts 3/8in.
- 100 S/S short-nuts 1/8in.
- 100 S/S faceguard screws
- 100 black shoulder pad accessory screws
- 24 faceguard washers
- 12 Armourguard® Elite™ loop straps
- 12 Polyarmour loop straps
- 12 Armourguard® loop straps
- 12 plastic chin strap buckles
- 12 should pad laces
- 12 barrel lace locks
- 12 1-1/2in. Key hole slides (1" for youth kit)
- 12 1-1/2in. t-hooks (1" for youth kit)
- 4 1-1/2in. x 20 elastic shoulder pad straps (1" for youth kit)
- 1 helmet inflator pump
- 1 yard of 1in. loop tape
- 1 glycerin bottle

1150469

Youth Approved

\$299⁹⁹ EA

1376903

Varsity



Metal Chinstrap Buckle

FBMCSBXXPK

\$20⁹⁹ PACK OF 50



1/8" T-Nut Short

FBSTNXXPK

\$16⁹⁹ PACK OF 50



1/4" Chinstrap Snap

FBCSSXXPK

\$23⁹⁹ PACK OF 50



1/2" T-Nut Long

FBLTNXXPK

\$16⁹⁹ PACK OF 50



3/8" T-Nut Medium

FBMTNXXPK

\$16⁹⁹ PACK OF 50



1/2" Helmet Screw

FBHSXXPK

\$10⁹⁹ PACK OF 50

HELMET HARDWARE VALUE PACK

- 50 each of all helmet hardware: T-nuts, screws, snaps and buckles
- Includes plastic carrying case

1265200

300 pieces

\$109⁹⁹ EA ★

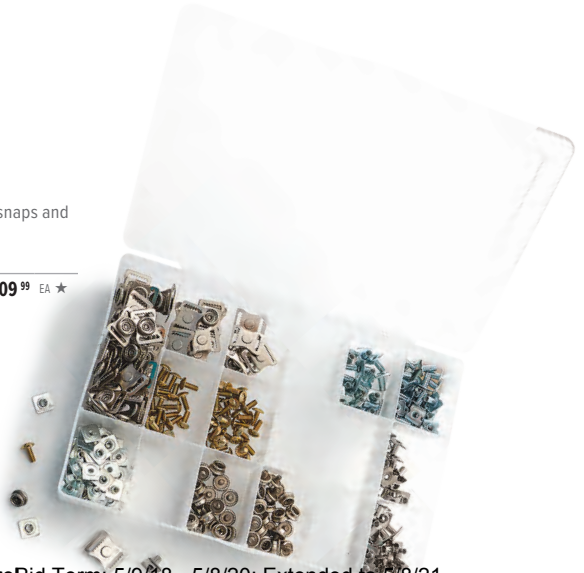

Bid #ESCNJ 17/18-31

Educational Services Commission of New Jersey

Athletic Equipment & Supplies

FOOTBALL



VETTEX™ MOUTHGUARD WITH LIP PROTECTION

- Protects lips, mouth and teeth
 - Exclusive patented breathing holes
 - Pliable thermo rubber for cushioning comfort
 - \$3,000 Dental Warranty
- Color Options: **Black, White.**

1403320 One Size Fits All - Specify Color **\$8.29** EA



MG180 MOUTHGUARD WITH STRAP

- Provides double impression for upper and lower teeth protection
 - Features one-piece quick release helmet strap
 - \$3,200 maximum dental injury warranty
 - 35-second custom fit
- Color Options: **Black, Clear, Yellow.**

1298741 Adult - Specify Color **\$2.09** EA



MOUTHGUARD

- Mouthguards should be used in contact and non-contact sports to reduce the risk of concussion and mouth related injuries
- Top quality Dental Vinyl for greater strength, comfort, ease of speech and breathing
- Adult size is for ages 11 and up
- 30-second custom fit
- Youth Color Options w/Strap: Black, Gold, Scarlet, Royal
- Adult Color Options w/Strap: Black, Gold, Scarlet, Royal, Green, Maroon, Navy, Orange, Purple, Clear
- Adult Color Options Strapless: Black, Gold, Scarlet, Royal, Green, Maroon, Navy, Purple

MSMOUT Adult w/ Strap - Specify Color **\$17.99** PACK OF 25
1179620 Adult Strapless - Specify Color **\$1.39** EACH
1403270



PRO ADULT MOUTHGUARD

- Multi-layer construction with an internal shock-absorbing frame offers optimal protection and deflects impact away from teeth
- Shock absorbing jaw pads help reduce the force of impact and create a channel for improved breathing
- Includes a quick-release tether and also works with braces
- 12 per pack

1361360 Adult - Smoke/Black Only **\$84.99** PACK
1361360EA Adult - Smoke/Black Only **\$7.99** EA



GEL MAX ADULT CONVERTIBLE MOUTHGUARD

- Gel Fit liner custom molds to teeth for tight, comfortable fit
- Exoskeletal Shock Frame
- Triple layer design with integrated breathing channel
- Convertible tether allows for use with or without a strap
- Adult Team packs of 48 sold in bulk poly bag
- Color Options: **Black, Blue/Black**

1384275 Specify Color - Each **\$12.49** EA
1379351 Specify Color - 48/Pack **\$499.99** PACK



MAX AIRFLOW MOUTHGUARD

- Comfortable "no-mold" instant fit lip guard
- Translucent medical grade silicone remains flexible and resilient
- Low-Profile integral bite pads for comfort
- Maximum AirFlow breathing channel
- Works with braces and includes convertible tether

1399657 Specify Size & Color **\$14.99** EA



SUPERFIT MOUTHGUARD

- SLIM FIT: Less material, lower profile, better breathability
- For the ultimate breathability & speak-ability
- Shock-absorbing gel windows for added jaw protection
- Gel-Fit liner for tight, comfortable fit

1399666 Specify Size & Color **\$21.99** EA



MOUTHGUARD FOR BRACES

- Essential protection for athletes with braces
- Specifically designed to conform to upper brace brackets
- Adapts to changes in mouth structure as teeth adjust
- Made with 100% medical-grade silicone

1399675 Specify Size & Color **\$19.99** EA



SCRIMMAGE HELMET COVERS (12-PACK)

- ONE SIZE FITS ALL
- 1/2" gripper elastic bottom to prevent slippage
- 90% Cotton/10% Lycra

1071948 **\$54.99** DZN





TRIPLE GAME PLAN WRIST COACH

- Allows communication of plays between players & coaches
- Specially designed with 3 game plan compartments
- Adult: 6 1/2" long band with 3" x 5" windows
- Youth: 4 1/2" long band; 2 3/4" x 3 1/2" windows
- Available in Black or White

1298772	Adult/Black	\$11.99 EA
1298789	Adult/White	\$11.99 EA
1298796	Youth/Black	\$11.99 EA
1298802	Youth/White	\$11.99 EA



TRIPLE PLAYMAKER WRIST COACH

- Includes 3 windows for storing 60-300+ plays at once
 - Features Cutters' C-FLEX material for a snug, flexible fit
 - Pink color is made with Terry Cloth in Adult size only
 - Machine Washable and Dryable
- Color Options: **Black, Dark Green, Gold, Maroon, Navy, Orange, Pink, Purple, Red, Royal, White.**

1385067	Specify Color	\$15.99 EA
---------	---------------	------------



GAME DAY WRISTBAND

- Terrycloth sweatband with game plan compartment
 - Weather-proofed for long use
 - 3" x 5" play card window
- Color Options: **Black, White.**

FBSWBBKX	Specify Color	\$9.99 EA ★
----------	---------------	-------------



REVERSIBLE SCRIMMAGE VESTS

- Polyester mesh construction
 - Reversible jerseys with elastic bottom
- Color Options: **Dark Green/Gold, Orange/Gold, Red/Black, Royal/Gold, Royal/Red, Silver/Black.**

1262711	Adult	\$77.99 DZN ★
1262773	Youth	\$77.99 DZN ★



HEAVY DUTY VINYL MESH PRACTICE VEST

- Wide elastic Velcro® straps
 - Heavy duty vinyl mesh
 - Slips over helmet and shoulder pads easily without assistance
 - Light and breathable but very durable
 - 17"W x 20"L
- Color Options: **Black, Blue, Gold, Green, Kelly, Orange, Red, White.**

1398268	Specify Color (12/Pack)	\$239.99 DZN
---------	-------------------------	--------------



NEW NEON COLORS!

LIGHTWEIGHT SCRIMMAGE VESTS

- Polyester mesh vest
 - Reinforced neck and armholes
 - Elastic waistband
- Color Options: **Black, Gold, Kelly, Neon Green, Neon Orange, Neon Yellow, Orange, Purple, Royal, Scarlet.**

C46Y	K thru 3rd Grade	\$4.99 EA ★
C46	4th-6th Grade, Middle School & Up	\$5.29 EA ★
C47N	Adult	\$7.99 EA ★

HEAVY DUTY SCRIMMAGE VEST

- Polyester Porthole mesh, elastic waist, large neck and arm holes.
 - Sewn with no shoulder seams to reduce ripping and extend life.
- Color Options: **Black, Gold, Kelly, Purple, Royal, Scarlet.**

C48	Specify Color	\$9.99 EA ★
-----	---------------	-------------





FOOTBALL



NEW!

WAIST LENGTH MESH JERSEY

- Dazzle polyester double ply cowl
- Mitered V-neck collar
- Polyester porthole mesh body with dazzle sleeves
- Covered stitched for durability

CPFJ55Y Youth S/M, L/XL \$13.99 EA
CPFJ55 Adult S/M, L/XL, 2XL/3XL \$14.99 EA



FOOTBALL PRACTICE PANT

- 14 oz. double-knit polyester fabric
- Full duke crotch with traditional front lace closure
- 2.5" wide non-roll elastic slotted waistband
- Elastic leg band
- Color: White

1374276 XS-6XL \$15.99 EA



FOOTBALL BELTS

- Heavy-duty polypropylene web with heat-sealed ends.
- Nickel-plated D-rings, double riveted.
- 60" long.

Color Options: **Black, Gold, Kelly, Navy, Royal, Scarlet, White.**

FBBLT1 1" Width \$2.99 EA



ELUSIVE JERSEY

- 100% eXtreme mesh Cationic polyester tricot mesh
- DAZZLE moisture management yoke
- Full length "Elusive Cut" jersey with lycra side inserts
- Mitered V-neck and sleeve cuffs with elastic

AA750EY Youth S-L \$22.99 EA
AA750E Adult S-3XL \$24.99 EA

ELUSIVE CUT JERSEY

- 100% eXtreme mesh cationic polyester, 100 denier tricot mesh with moisture management finish body
- Full length "Elusive Cut" jersey with lycra side inserts for increased flexibility, performance, and comfort
- Cover hemmed elastic sleeve cuffs

AA753EY Youth S-XL \$24.99 EA
AA753E Adult S-3XL \$27.99 EA



SOLO SERIES INTERGRATED DAZZLE PANT

- 100% stretch polyester DAZZLE cloth
- Five panel construction with duke crotch
- Five sewn-in perforated EVA pads with stretch mesh pad pockets
- Attached self-material belt with chrome rings
- Entire pant is washable

AA688DY Youth XS-3XL \$24.99 EA
AA688D Adult S-3XL \$31.99 EA



SOLO SERIES INTERGRATED POLY PANT

- 100% double-knit 13oz polyester
- Five panel construction with duke crotch
- Five sewn-in perforated EVA pads with stretch mesh pad pockets
- Attached self-material belt with chrome rings
- Entire pant is washable

AA687PY Youth S-2XL \$20.99 EA
AA687P Adult S-3XL \$29.99 EA



FLAG-A-TAG



SONIC FLAG BELTS

- Featuring Flag-A-Tag's patented release system
- Sonic belts emit an audible "pop" to signal the play is dead
- Built for institutional use
- Flag size: 2"W x 17-1/4"L
- Sold by dozen per size/color
- Color Options: **Gold, Kelly, Royal, Scarlet, White.**

8674223 42" FLAG BELTS \$80⁹⁹ DZN ★
8675223 52" FLAG BELTS \$80⁹⁹ DZN ★

SOCKET & PLUNGER "POPS" WHEN PULLED FROM SOCKET



SOCKET ANGLES BELT AWAY FROM PLAYER

PROGRAM KIT

- Designed to outfit two teams of twelve players
- Includes 24 belts with flags, 2 storage rings, and 1 flag football rule book
- Select either 42" or 52" belts
- Choose two colors: **Gold, Kelly, Royal, Scarlet or White**

8671000 \$189⁹⁹ SET ★



JUNIOR FLAG FOOTBALL PACK

All the equipment needed for a game!

Package Includes:

- 24 - 42" Flag belts with flags (12 each Red and Yellow)
- 24 - C46 Lightweight Adult mesh vests (12 each Red and Yellow)
- 1 - Junior size rubber football
- 8 - Game cones (12")

- 2 - Official's pinnies
- 1 - Stopwatch
- 2 - Flag belt storage rings
- 1 - USFTL rule book and official's manual
- 1 - Wheeled deluxe storage/transport bag

1238037 64 Pieces \$399⁹⁹ PACK ★



HALF LENGTH NUMBERED SCRIMMAGE VESTS

- Half length mesh vest
- Does not cover flag belts when worn
- 6" White Numbers on Front, 8" on Back

1390543	Red S/M (#0-5, 10-15)	\$79 ⁹⁹ SET
1390544	Royal S/M (#0-5, 10-15)	\$79 ⁹⁹ SET
1390545	Gold S/M (#0-5, 10-15)	\$79 ⁹⁹ SET
1390546	Kelly Green S/M (#0-5, 10-15)	\$79 ⁹⁹ SET
1390547	Red M/L (#20-25, 30-35)	\$79 ⁹⁹ SET
1390548	Royal M/L (#20-25, 30-35)	\$79 ⁹⁹ SET
1390549	Gold M/L (#20-25, 30-35)	\$79 ⁹⁹ SET
1390550	Kelly Green M/L (#20-25, 30-35)	\$79 ⁹⁹ SET
1390551	Red XL/XXL (#40-45, 50-55)	\$79 ⁹⁹ SET
1390552	Royal XL/XXL (#40-45, 50-55)	\$79 ⁹⁹ SET
1390553	Gold XL/XXL (#40-45, 50-55)	\$79 ⁹⁹ SET
1390554	Kelly Green XL/XXL (#40-45, 50-55)	\$79 ⁹⁹ SET



FLAG-A-TAG® STORAGE RINGS

- Provides easy storage for all types of flag belts
- Holds 12 - 18 belts

8671010 \$4⁹⁹ EA ★



SONIC CONVERSION PACKAGE

- Converts a 2 flag belt into a triple flag belt
- Includes 12 sockets, 12 Stems and 12 flags
- Color Options: **Gold, Kelly, Royal, Scarlet, White.**

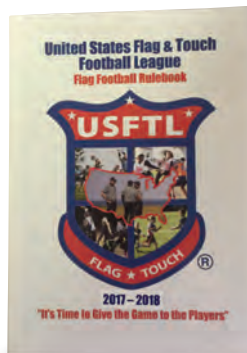

USFTL RULE BOOK AND OFFICIALS MANUAL

- Standard rule book for all USFTL leagues
- Rule Highlights include: Definitions, Official's Manual, Games, Playing Fields, Equipment, Periods, Time factors, Overtime, Substitutions, Scoring, Conduct, Penalties, Ranking System ...and much more

86703XXX \$19⁹⁹ EA ★



FLAG FOOTBALL BELTS

Three flags permanently sewn onto the web belt. Entire belt comes off - no parts to lose! Belts are washable.

- Vinyl coated polyester flag will not tear
- Flag size: 2 1/4"W x 14 1/2"L
- Heavy duty polyethylene "gator clip"
- Adjusting slide for sizing
- Belt clips are color coded to indicate size
- Specify size when ordering:
- SMALL: 22" - 32" RED Belt Clip
- MEDIUM: 28" - 38" YELLOW Belt Clip
- LARGE: 32" - 44" BLUE Belt Clip
- X-LRG: 38" - 52" GREEN Belt Clip

1149487	Red Flags - Specify Size	\$4.09	EA	★
1149524	Yellow Flags - Specify Size	\$4.09	EA	★
1149562	Blue Flags - Specify Size	\$4.09	EA	★
1149609	Green Flags - Specify Size	\$4.09	EA	★



ADJUSTABLE FLAG BELTS

- Each belt includes 2 flags
 - Flags attached with hook-and-loop belt attachment that slide over belt
 - Flag size: 2"W x 16 1/4"L
 - Steel D-ring belt loops for sizing
 - One size fits most - belt length 42"
- Color Options: **Blue, Red, Yellow.**

MSFB	Belts With Flags	\$2.79	EA	★
MSXBELTS	Belts Only	\$6.49	SET OF 6	★
MSFLAGS	Flags w/Belt Attachment Only	\$5.89	SET OF 6	★

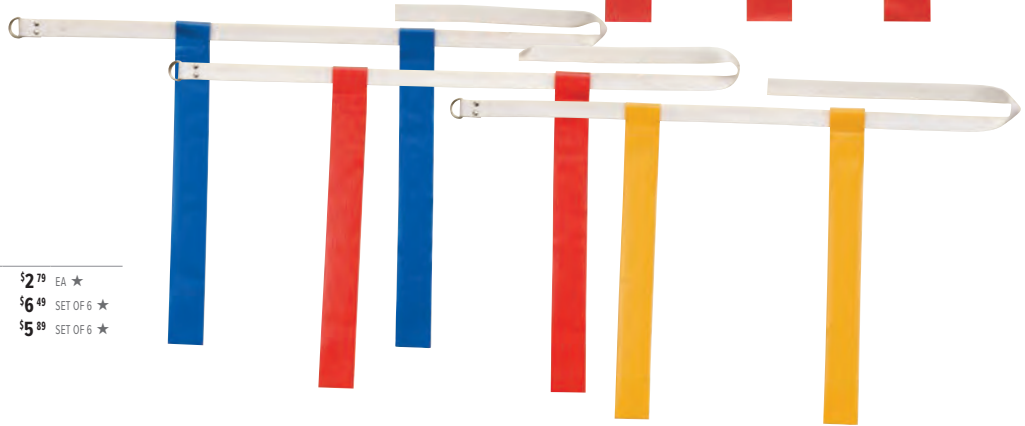

TRIPLE THREAT DOWN BOX & SCOREBOARD

- Combines the features of a down box and scoreboard into a single unit
- Score can be shown on both sides of the down indicator
- Made of strong light weight PVC material
- Easily disassembles for storage
- 7'H when assembled
- Includes plastic numbers, 2 dry erase score sheets with markers and pole



1196160		\$130.99	EA	★
----------------	--	----------	----	---



STACKABLE SIDELINE MARKERS

- 13"H, 3 sided pyramid shaped markers
- Made of tough, flexible vinyl
- Stackable for easy storage
- 5-piece set includes: 2-G's, 2-20's, 1-40
- 11-piece set includes 2/G's, 2/10's, 2/20's, 2/30's, 2/40's, 1/50

1245127	5 Piece Set for Flag Football	\$165.99	SET	★
1245134	11 Piece Set	\$319.99	SET	★



DAY/NIGHT SIDELINE MARKERS

- Soft, crushable foam core inside durable vinyl cover
- Folding design for flat storage
- Hook and loop fasteners with weighted bottom to maintain upright position
- 15"H X 15"W with 13"H numbers
- Includes 2-G's, 2-20's and 1-40

1249354	5 Piece Set for Flag Football	\$159.99	SET	★
----------------	-------------------------------	----------	-----	---

OFFICIAL'S PENALTY FLAG

- Regulation size 15" x 15" nylon with a weighted center
- Available in yellow only



FBREFFLG		\$8.99	EA	★
-----------------	--	--------	----	---



BALL SPOTTER

- 3 1/2" diameter pliable rubber disc

1240245	Orange	\$10.99	EA
1240252	Yellow	\$10.99	EA

WEIGHTED ANCHORLESS PYLONS

- Stands by itself, no anchor system required
- Bright, fluorescent orange vinyl covered foam with a weighted bottom
- 18"H x 4"W x 4"D - 4 lbs. each



MSWPYLON		\$41.99	SET OF 4	★
-----------------	--	---------	----------	---



PORTABLE COOLING SYSTEM

- Frame constructed of heavy wall powder coated steel
- Cools temperature in front of fan 10-20 degrees; up to 50' away
- Transports easily on two 10" "No Flat" wheels
- Includes: 50 PSI pump, 24" fan, 5 brass misting heads, 20 gallon tank (provides approximately 7 hrs. of operation)
- Dimensions: 68"H x 28"W x 31"D - 135 lbs. (empty)
- Requires 115V electrical outlet
- Warranty: Fan - 2 Years; Pump - 1 Year; Parts - 1 Year; Frame - 5 Years

1240405

\$1,799⁹⁹ EA ★



Bid #ESCNJ 17/18-31

Educational Services Commission of New Jersey

Athletic Equipment & Supplies



1,129⁹⁹

POWERED TEAM DRINKER

- Cart constructed of heavy wall powder coated steel
- Drinking tube constructed of non-corrosive PVC
- Transports easily on two 10" "No Flat" wheels
- Includes: 6 Retractable coil drinking hoses with quick shut-off nozzles
- 20 gallon translucent blue tank with sanitizing tablets
- Rechargeable 12V/12amp power pack provides 8 hours of use
- Dimensions: 50"H x 21"W x 25"D - 135 lbs. (empty)

1240412 **\$1,129⁹⁹** COMPLETE UNIT ★

REPLACEMENT PARTS

SPCHOSE	Coiled Hose and Shut Off	\$39⁹⁹ EA ★
SPCWAND	Shut Off Assembly	\$20⁹⁹ EA ★
SPCBAT	Replacement Battery	\$79⁹⁹ EA ★
ZX3930034	Replacement Battery Charger	\$61⁹⁹ EA ★
SPC16	Sanitizing Tablets (150/Bottle)	\$8⁹⁹ BOT

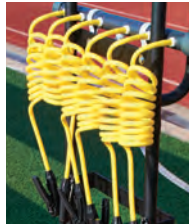

PORTABLE WATER CHILLER

- Cart constructed of heavy wall powder coated steel
- Add ice to the cooler, attach water hose (not included) and the copper coil inside the tank cools drinking water as it passes through to the drinking stations
- Transports easily on two 10" "No Flat" wheels
- Includes: 6 retractable coil drinking hoses w/ quick shut-off nozzles and 10 gallon cooler
- Dimensions: 50"H x 21"W x 25"D - 46 lbs.

1240429 **\$679⁹⁹** EA ★

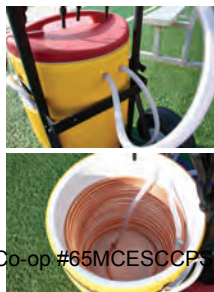

1,529⁹⁹

POWERED TANKER WITH CART

- NEW & IMPROVED Cart design w/ translucent blue tank
- Steel constructed tube frame w/ aluminum bottom deck and top utility shelf (water bottles not included)
- Drinking tube constructed of non-corrosive PVC
- Rides & steers smoothly on 4 heavy duty wheels with 10" pneumatic tires
- Front wheels swivel for easy maneuverability
- Equipped with optional use towing attachment
- Includes 8 coiled drinking hoses, sanitizing tables, 35 gallon FDA, NSF approved tank
- Rechargeable 12V / 12amp Power Pack: 8 hours of use
- Dimensions: 43"L x 20"W x 54"H - 140 lbs. (empty)

1378677 **\$1,529⁹⁹** COMPLETE UNIT ★

WATER BOTTLES SOLD SEPARATELY SEE PAGE 154



DRINKING STATION

- Frame is made of galvanized steel tubing with removable legs for easy transport and storage
- The drinking tube is made of non-corrosive PVC
- Includes 8 drinking stations with shut-off nozzles
- Connects to a standard water hose (not included)
- Dimensions: 43"H x 53"L - 25 lbs.

1240436 **\$399⁹⁹** EA ★

BSN SPORTS

BOTTLE CARRIER WITH 8 QUART BOTTLES

- PVC molded water bottle carrier with carry handle
- Holds 8 - Quart size big mouth bottles with pop-up spouts

1379309	Carrier & 8 Bottles	\$40.99 EA ★
1379308	Carrier Only	\$24.99 EA ★
1379307	Quart Size Bottle Only	\$3.49 EA ★



FOLDABLE CARRIER WITH 6 QUART BOTTLES

- PVC molded water bottle carrier with carry handle
- Folds flat for easy storage
- Holds 6 - Quart size big mouth bottles with pop-up spouts

1379325	Carrier & 6 Bottles	\$37.99 EA ★
1379326	Foldable Carrier Only	\$24.99 EA ★
1379307	Quart Size Bottle Only	\$3.49 EA ★



POWER BREEZER®

- Reduce temperatures by up to 27 degrees F
- Keep players, staff, students and fans cool and comfortable
- Unique water atomization technology-No nozzles or refill pads needed
- Integrated easy-fill 100 gallon water tank
- Fan assembly stores inside of tank for easy transport and storage
- Oscillating fan assembly can cool up to 3,000 square feet of outdoor space
- Effective cooling distance up to 80 feet
- One tank of water lasts up to 50 hours of run time
- Does not get people or equipment wet
- Made in the U.S.A.

2 Year Limited Warranty

1384280 275 lbs. **\$4,999.99 EA**

WATER COOLER CART

- Main Frame constructed with 1" steel tubing
- Black Powder Coated Finish
- 10" Semi Pneumatic Wheels
- Holds any cooler up to 10 gallons (sold separately)
- Removable wire basket for cups or supplies
- Can be used indoors/outdoors

1373999 22"D x 26"W x 49"H - 30 lbs **\$254.99 EA ★**



GATORADE® PACKAGE

- Ideal for fueling athletes during games, practice or timeouts either on the field or courtside!
- Package includes: 6-32 oz. Gatorade Squeeze Bottles and Carrier, 1-case (2,000) of 7 oz. disposable cups, 1-case (40-8.5 oz.) Lemon-Lime Powder packets (Yields 40 gallons), 1- 7 gallon Gatorade Cooler and 1 Cooler Cart!

1371311 **\$499.99** PACK **\$615 RETAIL VALUE**





10 GALLON

7 GALLON

3 GALLON

60 QUART ON WHEELS

GATORADE® DISPENSERS/COOLERS

- Insulated to keep your favorite beverage cold
- Each has built in handles and pour spout.

1306798	3 Gallon	\$56 ⁹⁹ EA
1306835	7 Gallon	\$89 ⁹⁹ EA
1306781	10 Gallon	\$109 ⁹⁹ EA
1306828	60 Quart Wheeled Ice Chest	\$122 ⁹⁹ EA



GATORADE® DOUBLE-COOLER CART

- Metal frame construction with heavy-duty transport casters
- Overall dimensions: 39"H x 18"W x 41"L
- Designed to hold one 3 gallon and one 7 or 10 gallon Gatorade cooler
- Includes cup dispenser and 2 shelves
- Coolers sold separately

1306743 61 lbs. \$599⁹⁹ EA

GATORADE® 70Z CUPS

- Hygienic and disposable
- 2000 cups per case
- 20 sleeves each containing 100 cups

1376906 \$114⁹⁹ PACK



GATORADE® CUP CARRIER WITH LID

- Sets nicely on the top of any standard 7 or 10 gallon cooler
- Holds 18, 8 oz. or 12 oz. paper cups
- Convenient handles allow for easy transport and serving

1379353 \$39⁹⁹ EA



GATORADE® BOTTLES AND CARRIER

- 32 oz. wide mouth squeeze bottle
- Plastic carrier holds 6 bottles
- Sold separately

1420364 Bottles Only \$6⁴⁹ EA
1420365 Carrier Only \$29⁹⁹ EA



GATORADE® ANTIMICROBIAL TOWEL

- 100% Cotton and measures 38" inches by 24"
- Towels feature aegis antimicrobial treatment that keeps them fresh.
- Do not require bleach to stay sanitary for up to 50 washings.

1419992 38" x 24" \$14⁹⁹ EA



GATORADE® THIRST QUENCHER POWDER

- Keep hydrated with Gatorade Thirst Quencher - Scientifically formulated to help athletes perform at their best during the course of training and competition
- One case includes (40) 8.5 oz. pouches of Lemon Lime powder (Yields 1 Gallon each)
- Sold in full cases only

1306750 Lemon Lime \$89⁹⁹ CASE OF 40 PACKETS



TIDI-COOLER STAND SET

Includes: stand, trash can, 5 gallon Igloo® cooler, and cup dispenser

1263244	Black Stand with Green Cooler	\$244.99	SET ★
1263251	Black Stand with Yellow Cooler	\$244.99	SET ★
1255669	Green Stand with Green Cooler	\$244.99	SET ★
1255676	Green Stand with Yellow Cooler	\$244.99	SET ★

TIDI-COOLER STAND

- 100% lightweight, rust free aluminum with powder coated finish
- Wide stance base for more stability
- Includes Tidi-Court basket and security cable with keyed lock to keep lid and cooler secure to stand
- Designed for 5 gallon coolers
- Cooler sold separately

1255652	Green Stand & Basket	\$162.99	EA ★
1263268	Black Stand & Basket	\$162.99	EA ★



LOCKER ROOM TOWELS (12-PACK)

• 100% cotton terry cloth

MSTOWELS	22"W x 44"L	\$40.99	DZN ★
----------	-------------	---------	-------

ENDURACOOOL™ TOWEL

- Cools instantly when wet - last up to 2 hours
- Wearable Ultra Violet Protection Factor (UPF) 45 provides sun protection when covering the skin
- Reusable and machine washable with detergent

Color Options: **Black, Blue, Pink.**

1366539	Specify Color	\$14.99	EA
---------	---------------	---------	----



SQWINCHER SOWEEZE FREEZER POP

- Electrolyte replenishing, freezer pops are available in five assorted flavors: Lemon Lime, Orange, Cherry, Mixed Berry and Grape
- Helps reduce core body temperature and combat heat stress and fatigue
- Scientifically developed formula is designed to be absorbed by the body faster than water, helping to replenish the electrolytes and minerals needed for proper rehydration
- Each case contains 150 Freezer Pops (15 packs of 10, 2 of each flavor per pack)

1297843	\$62.99	CASE-OF-150 POPS
---------	---------	------------------



SKYSCAN™ TI-PLUS HEAT INDEX WARNING SYSTEM

- Easy to read arrow display showing all ranges of dangerous heat conditions
- Audible warning sounds before heat index reaches critical levels
- Accurate display temperature, relative humidity and heat index
- Critical info is stored in memory for 24 hrs. and can be re-displayed
- Also functions as a countdown timer, stopwatch and alarm

1150216	\$159.99	EA
---------	----------	----



HEAT STRESS/DEW POINT STOPWATCH

- Accurate, responsive and simple Heat Index and Comfort Index readings
- Temperature and Humidity readings
- 1/100 second precision with 99 Lap Counter
- 30 Lap/Split Memory & 10 Hour Count Down Timer
- Calendar and Time display (12/24 hr format)
- Daily Alarm & Water Resistant up to 30 Meters

1384281	\$41.99	EA
---------	---------	----



STRIKE ALERT HD LIGHTNING DETECTOR

- Intuitive Graphical display
- Shows lightning strike distance up to 40 miles away
- Displays 1-hour storm trend and intensity
- Tells you how long lightning has stopped so play can resume
- Offers 360 degree storm tracking in all directions
- Audible and vibrating warnings
- Low power consumption using two

1384282	\$249.99	EA
---------	----------	----



SKYSCAN™ P5 LIGHTNING DETECTOR

- Detects lightning as far as 40 miles away and accurately ranges its approach by both an audible tone and by four LED's which are ranged in miles (0-3, 3-8, 8-20, 20-40)
- Requires (2) 9V batteries (not included)
- AC adapter not included
- Rugged weather resistant case

SKYSCANX	Portable Unit	\$299.99	EA
20026501	Soft Carry Case	\$39.99	EA
20026502	110v AC Adapter	\$39.99	EA



Bid #ESCNJ 17/18-31
COOLERS

WATER COOLER

- Rugged, durable 400 series industrial strength water coolers with Ultratherm® insulation keeps water ice cold
- UV Protection prevents surface from chipping, peeling, or rusting
- FDA approved white inner liner is easy to clean and resists stains
- Lid cord attached to prevent loss
- Optional cup dispenser holds approximately 200 (4 or 4.5 oz.) cups-not included

5 Year Limited Warranty

MSIGL05X	Yellow - 5 Gal.	\$69 ⁹⁹ EA
MSIGL010	Yellow - 10 Gal.	\$99 ⁹⁹ EA
1263220	Green - 5 Gal.	\$69 ⁹⁹ EA
1263237	Green - 10 Gal.	\$105 ⁹⁹ EA
1376916	Orange - 5 Gal. Seat Top	\$69 ⁹⁹ EA
1384468	Orange - 10 Gal. Seat Top w/Cup Dispenser	\$99 ⁹⁹ EA
MSCUPDIS	Optional Cup Dispenser	\$31 ⁹⁹ EA
1384470	4.25 oz. Cone Cup - 5000/Case	\$223 ⁹⁹ EA



HYDRATION



MAXCOLD 50 ROLLER

- Cool Riser Technology™ with MaxCold insulated body and lid keep ice for 5 days at 90 degrees F*
- Wide grip push-button and locking telescoping handle
- Integrated lid tie-down loops
- Oversized soft-ride sport wheels
- Grab-through side cooler handles
- 50 Quart (86 can) capacity
- Available in blue only

1384465 27.5"L x 16.75"W x 19"H \$98⁹⁹ EA

GLIDE PRO 110 ROLLER

- Horizontal Slide-and-Lock telescoping handle provides maximum leverage and lightens lifting loads
- Cool Riser technology with Ultratherm® insulation in the body and lid keep ice for 5 days at 90 degrees F*
- Oversized, soft-ride, sport rally wheels with UV inhibitors
- Virtually indestructible zinc-plated metal hinges
- Threaded drain plug for hose hook up and easy draining
- 110 Quart (150 can) capacity
- Available in White only

1384464 40"L x 19"W x 20"H \$203⁹⁹ EA



150 QUART QUICK & COOL™

- Quick-access hatch lets you access contents without letting the cold air escape
- UV inhibitors guard against sun damage
- Stain and odor-resistant liner
- Reinforced swing-up handles with tie-down
- Dual snap-fit latches secure lid
- Threaded drain plug for hose hook up
- 150 Quart (248 can) capacity
- Available in White only

MSIGL00150 20"H x 18.5"W x 42"L \$199⁹⁹ EA



SUPER TOUGH™ STX COOLER

- Bolt-through-body, comfort grip side handles with gasketed heavy-duty back-up plates
- Stainless steel latch for longer life and secure closure
- Specially anchored, heavy-duty stainless steel hinges
- UV inhibitors guard against sun damage
- 40% Heavier Body – for increased durability
- Triple-snap drain plug for quick draining and easy cleaning
- Fully foamed lid for maximum cold retention
- Holds ice up to 4 days at 90 degrees F
- Dual stainless steel lid straps for even greater lid security
- Available in White/Org Only

1384466 54 Qt. - 26"L x 15"W x 15.75"H \$132⁹⁹ EA
1384467 120 Qt. - 38.5"L x 17"W x 17.5"H \$215⁹⁹ EA





TRAINING



PORTABLE LACROSSE GOAL

- Full size portable lacrosse goal
- Sets up in minutes
- Includes free carry bag with wheels

1344073 7'H x 7'W x 6'D - 25 lbs. \$329⁹⁹ EA



GOAL SOLD SEPERATELY

PORTABLE LACROSSE GOAL CREASE (MEN'S)

- Portable official 18' men's size lacrosse crease
- Sets up in seconds
- Includes internal weights for use on turf fields and grounds stakes for use on grass fields
- Includes free carry bag

1344080 18' Diameter - 9 lbs. \$159⁹⁹ EA



PORTABLE BARRIER NET

- Multi-sport portable barrier net
- Sets up in minutes
- Includes free carry bag with wheels

1344097 12 1/2'H x 21 1/2'W - 56 lbs. \$499⁹⁹ EA



LACROSSE GOAL CART

- Move heavy goals easily with only one person and without damaging your field
- Constructed of heavy-duty 1 3/8" OD galvanized steel tubing with a long lasting powder coated finish
- Rolls smoothly on 10" semi-pneumatic tires
- Fits most 6' x 6' portable goals

1390952 \$349⁹⁹ EA

RAGE CAGE

PORTABLE LACROSSE GOALS

- 6'H x 6'W x 7'D official size goal with 4mm net (Club-V4) or 3mm net (B100-V4)
- Folded size: 48"H x 47"W x 13"D
- 1.75" O.D. (Club-V4), 1.5" O.D. (B100-V4), 16 gauge orange powder-coated steel tubing
- Pre-strung net with full perimeter hem
- Carrying strap included
- Improved one-time assembly required

1369693 Club-V4 \$489⁹⁹ EA
1375528 B100-V4 \$339⁹⁹ EA



BSN SPORTS

1. 2.

PASS BACK TARGET

- 7'H x 4'W steel frame
- 4'H x 3'W rebound surface area
- Frame adjusts for varied rebound angles
- Add the STX Pass Master Cover and improve passing fundamentals and accuracy

1) BSN Frame and Solid Target \$259⁹⁹ EA ★
2) STX Pass Master Cover Only \$49⁹⁹ EA

1377188
1371638

STX

GOAL TARGETS

- Available in two styles for two levels of challenge
- Improves shooting accuracy
- Made of durable polypropylene with reinforced edges
- Includes easy-to-attach bungee fasteners



1334562 \$99⁹⁹ EA

NJ State Approved Co-op #65MCESCPS Metuchen/Garden State AppareBid Term: 5/9/18 to 5/8/20: Extended to 5/8/20

2) Junior \$99⁹⁹ EA

Bid #ESCNJ 17/18-31

Educational Services Commission of New Jersey

Athletic Equipment & Supplies

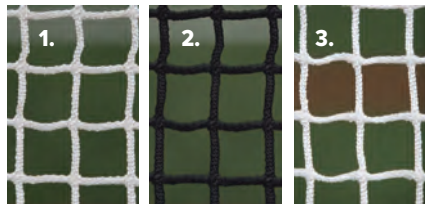

1. LACROSSE NETS

- Braided, knotless, nylon lacrosse nets
- Extruded thread with built in UV treatment and weather protection
- Includes lacing cord

1382863 Professional - White 6mm **\$179.99** EA ★

2. LACROSSE NET 5MM - BLACK

- Black, 5mm knotless nylon lacrosse net, includes lacing cord

1382861 Championship - Black 5mm **\$149.99** EA ★

3. LACROSSE NET 4MM

- White, 4mm knotless nylon lacrosse net, includes lacing cord

1272925 Practice - White 4mm **\$114.99** EA ★

NEW!

PREMIER LACROSSE GOALS

- Never spend time lacing your net again with our innovative new rod and net sleeve attachment system
- Removing the net in the offseason extends its lifespan
- 3/8" stainless steel lacing rods will not rust
- 6mm, 1.5" mesh, braided knotless nylon with 18 oz. white vinyl sleeves
- Includes 4 heavy duty ground anchors
- Meets all NCAA® and NFHS requirements

LACPREGL 140 lbs. Per Goal **\$949.99** PR ★



Sport Write!
COACHING TOOLS

PRO LACROSSE DRY-ERASE BOARD

- Large format enables entire team to see play
- 2 writing surfaces
- Includes premium dry erase marker
- 12 1/2"H x 16 1/2"W

1366487 **\$32.99** EA



MEN'S LACROSSE COACH'S BOARD

- Full field and half field writing surfaces front and rear
- Includes premium dry erase marker
- 8"W x 15 1/2"L

1388111 **\$13.99** EA ★



NOW WITH 6MM NET!



OFFICIAL LACROSSE GOALS

- 6'H x 6'W x 7'D official size NCAA® specified goal
- Constructed of 13-gauge, orange powder coated, 1.9" O.D. steel tubing and 3"W flat steel ground supports
- Lacing rods on inside front, uprights and rear ground supports
- Includes 6mm knotless nylon net, lacing cord and heavy-duty ground anchors

LACOFFGL 125 lbs. Per Goal **\$799.99** PR ★ **S&H**



PRACTICE LACROSSE GOAL

- 6'H x 6'W x 7'D deluxe practice goal
- Constructed of 13-gauge, orange powder coated, 1 1/2" O.D. steel tubing
- Lacing rods on inside front, uprights and rear ground supports

LACPRAGL 50 lbs. **\$199.99** EA ★

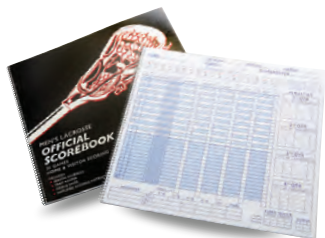

MEN'S LACROSSE SCOREBOOK

- Spiral bound, 12 1/2"W x 12"H
- Comprehensive scorebook and record keeper
- Contains home and visitor scoring for 31 games

1377127 **\$16.99** EA

BUCKET WITH LACROSSE BALLS

- Bucket with 5-dozen SEI/NOCSAE approved lacrosse balls (brand may vary)
- Heavy-duty 6-gallon plastic bucket with cushioned lid
- Available with men's white or women's yellow balls

1380843 White **\$134.99** EA ★

1380845 Yellow **\$134.99** EA ★



LACROSSE BALLS

- Official NOCSAE/SEI stamped, approved game balls meet NCAA and NFHS specifications
- Available in Men's (White) and Women's (Yellow)
- Soft white practice ball is not NOCSAE approved
- Brand of balls may vary

1377138 White **\$24.99** DZN

1377140 Yellow **\$24.99** DZN

1725UPB **\$39.99** DZN





WORLD CLASS FIELD HOCKEY GOAL

- Constructed of 2" x 2" square heavy gauge aluminum tubing
- Front goal mouth primed and painted white, 3/4" x 18"H black, painted wood bottom boards
- Official size 7'H x 12'W x 4'D
- Shipped in (6) total pieces for easy assembly
- Includes 2.5mm, 1 1/2" x 1 1/2" mesh, weather treated polyethylene net, net fasteners and transport wheels

1275049

SN383ELM

Weight: 200 lbs. Per Goal

Replacement Nets

~~\$2,999~~⁹⁹ PR 

~~\$184~~⁹⁹ PR ★

PRACTICE FIELD HOCKEY BALL

- Molded composite plastic construction for extended use
- Official size

PFH250XX

~~\$5~~⁹⁹ EA ★

NJ State Approved Co-op #65MCESCPS Metuchen/Garden State Apparel Bid Term: 5/9/18 - 5/8/20: Extended to 5/8/21



FIELD HOCKEY GAME BALL

- Smooth, white official field hockey game ball
- Seamless, friction free, waterproof PVC construction

1382832

~~\$6~~⁹⁹ EA



Bid #ESCNJ 17/18-31

Educational Services Commission of New Jersey

Athletic Equipment & Supplies

STICKS/PROTECTIVE



REVEL FIELD HOCKEY STICK

- This is the perfect stick for players transitioning to the next level
- It has the perfect shape to help players focus on control but introduces the key element of power to succeed
- 50% Carbon, 40% Fiberglass, 10% Kevlar, 23mm Bow, 550 grams
- Size: **34", 35", 36"**.

1395536 Specify Size \$79.99 EA



STALLION 200 FIELD HOCKEY STICK

- Cavity back technology pushes weight and material to the playing side of the stick which increases strength and deadens the ball on stops
- 10% Carbon, 85% Fiberglass, 5% Aramid, 22mm Bow, 565 grams
- Midi toe
- Grey/Yellow
- Size: **34", 35", 36", 37"**.

1395469 Specify Size \$80.00 EA



SURGEON RX 401 FIELD HOCKEY STICK

- Intermediate stick for players who want to maximize their precision game
- Same shape as the advanced and elite Surgeon RX models to enhance skills, but without the control channel
- 40% carbon construction for easier ball control than elite sticks, while introducing a stiffer feeling stick to the advancing player
- Nano Enhanced Resin System minimizes cracking and ensures the stick will remain responsive throughout its life

Size: **35", 36.5", 37.5"**.

1395564 Specify Size \$150.00 EA



PROBOT SHIN GUARDS

- The Probot shin guards offer the most protection of any Harrow shin guard
- Features a ventilated hard plastic shell with a removable, washable liner
- Popular among all levels of play
- Size: **SML, MED, LRG.**

1382833 Specify Size \$34.99 PR



FIELD HOCKEY GLOVE

- High density foam with a reinforced thumb hole and a ventilated palm for maximum protection without sacrificing comfort
- Available for the left hand only
- Available in Black only
- Size: **SML, MED, LRG.**

1382843 Specify Size \$15.99 EA



HAVOC BACKPACK

- 2 Large compartments and water bottle and extra compartment on each side, plus a large bottom compartment for shoes or dirty cloths
- Cushioned back with a stick pass through pocket and reinforced strap for added strength
- 12"W x 11"D x 18"L
- Color Options: **Black/Grey, Black/Lime, Black/Orange, Black/Pink, Black/Royal, Navy/Silver, Red/Silver.**

1382848 Specify Color \$79.99 EA



FIELD HOCKEY SCOREBOOK

- Rugged ringed binder scorebook lays flat when open for easy game and stat recording
- Records stats for up to 20 games with an extra page for season totals

1390953 \$16.99 EA



POLY ARC GOGGLES

- Polycarbonate frame contours to the face for reduced weight and added strength
- Silicone-lined, comfort grip strap for ultimate positioning on head
- Antimicrobial, moisture wicking comfort foam
- Meets ASTM standards for women's lacrosse

1386383 Specify Color \$49.99 EA



2SEE PRO - DUAL SPORT GOGGLE

- Patented low-profile design and unique wire configuration provide superior visibility in all directions
- Vented, silicone padding provides superior comfort and fit, does not absorb sweat or moisture, minimizes breakouts and is easy to clean
- Meets ASTM standard F2713-09 for field hockey and ASTM F3077 for women's lacrosse

1395568 Specify Color \$55.00 EA

NJ State Approved Co-op #65MCESCCPS - Meet the Green State Apple Bid Term: 5/9/18 to 5/8/20. Extended to 5/8/21

Bid #ESC NJ 17/18-31

Educational Services Commission of New Jersey

Athletic Equipment & Supplies



PHANTOM X

- Ultra abrasion-resistant PU cover with texture
- Great rebound, softness and foot feel
- High Retention Latex bladder system
- Hand-stitched
- Optimal for training or match-level play
- NFHS Approved

2 Year Limited Warranty



1397721 Size 5 - Specify Color \$49⁹⁹ EA



VORACITY

- Soft PU cover
- Hand stitched
- High Retention Latex bladder system

2 Year Limited Warranty

Color Options: **Black, Royal, Red/White/Black.**



1378532 Size 5 - Specify Color \$35⁹⁹ EA



ATTACK

- Highly durable PVC cover
- Butyl bladder
- Hand stitched

Color Options: **Black, Royal, Red/White/Black.**

1378536 Size 5 - Specify Color \$18⁹⁹ EA



CHAMPIONSHIP II

- Premium high-performance glossy PU cover
- High Air Retention Latex Bladder
- Offers the highest level of foot-feel, balance and playability
- Hand-stitched
- Optimal for match-level play
- NFHS Approved

2 Year Limited Warranty



1395098 Size 5 - White/Black \$74⁹⁹ EA



DESAFIO 395

- 0.15 mm TPU surface layer
- 1.0 mm EVA foam layer for exceptional softness
- Butyl Bladder with 2-ply carcass for shape retention
- Ideal for camp or recreation level play
- Machine stitched

1398280

Size 5 - White/Coral \$21⁹⁹ EA

1398367

Size 4 - Yellow/RWB \$21⁹⁹ EA

1393452

Size 3 - Camo/Yellow \$21⁹⁹ EA



DESAFIO 595

- Solid PU Cover
- Hand-stitched
- Flexible Spandex backing add liveliness
- SBR Foam layer for softness
- High rebound Latex bladder
- NFHS Approved

1393397

Size 5 \$49⁹⁹ EA



NUMERO 10

- 1.5 mm PU cover with zero wing latex bladder
- Hand-sewn; meets NFHS and NCAA regulations
- Solid White available in size 4 & 5
- Color Options: Wht/Blk, Wht/Roy, Wht/Grn, Wht/Org, Wht/Red, Yel/Org, Pink, Orange
- NFHS Approved

2 Year Limited Warranty



1342079 White - Specify Size 4 or 5 \$43⁹⁹ EA

1390159 Size 5 - Specify Color \$43⁹⁹ EA



ROYALE

- 1.8 mm PU cover with zero-wing latex bladder; hand sewn
- Meets NFHS and NCAA regulations
- Color Options: Wht/Blue, Wht/Grn, Wht/Yel, Wht/Org, Wht/Red, Wht/Mar, All White
- NFHS Approved

3 Year Limited Warranty



1390167

Size 5 - White/Black \$67⁹⁹ EA

1390168

Size 5 - Specify Color \$67⁹⁹ EA



SELECT



THOR

- 1.0 mm PU cover with zero wing latex bladder
- Includes Player # panel
- Meets NFHS and NCAA regulations
- Hand-sewn
- NFHS Approved

2 Year Limited Warranty



1390156

Specify Size - White/Black \$31⁹⁹ EA



BRILLIANT SUPER REPLICA

- PVC composite cover with Butyl bladder
- Excellent camp or recreational ball
- Machine stitched
- Size 5-White, Size 4-Yellow, Size 3-Orange
- Color Options: **Orange, White/Orange, Yellow**
- NFHS Approved

1390176 Specify Color/Size \$18⁹⁹ EA



UNITED

- 0.6mm PU cover with butyl bladder
- Includes player # panel
- NFHS Approved

1390180

Specify Size \$26⁹⁹ EA



DIAMOND

- Hand-sewn PU cover
- Newly developed backing layer provides softer feel and touch
- Patented Zero-Wing latex bladder for optimal bounce
- Size 5 - Red; Size 4 - Blue
- NFHS Approved

1388597

Specify Size/Color \$34⁹⁹ EA



NJ State Approved Co-op #65MCE SCPS Metuchen/Garden State Appare Bid Term 7/10/18 to 8/20/18 Extended to 5/8/21

Bid #ESCNJ 17/18-31

Educational Services Commission of New Jersey

Athletic Equipment & Supplies



Wilson
NCAA AVANTI

- Official championship match ball of NCAA® soccer
- Hand stitched top-grade composite leather cover
- SBR foam backed 32 panel construction

1384473 Size 5 **\$69.99** EA



Wilson
NCAA COPIA II

- Synthetic composite cover
- Butyl bladder with carcass windings
- 30 panel, machine stitched construction

1393021 Size 5 **\$19.99** EA



Wilson
NCAA FORTE FYBRID II

- 20-unique panels constructed with FYbrid™ Technology
- Micro-texture hybrid PU cover
- Panels backed with Japanese G10 foam for touch and control
- HPE bladder
- FIFA, NCAA and NFHS approved

1390091 White/Blue/Org - Size 5 **\$99.99** EA
1390092 Orange/Blue - Size 5 **\$99.99** EA



NEW!

ORDEM V

- Distorted Motion Graphic
- Fuse-welded synthetic leather casing with Aerowtrac grooves
- Compressed polyethylene and cross-linked, nitrogen-expanded foam layers
- 6-wing, carbon-latex air chamber with wrapped bladder

NKSC3128100 Size 5 **\$159.99** EA



CATALYST

- Premium PU cover
- Machine stitched

1376984 Size 5 **\$59.99** EA



PREMIER TEAM

- High quality PU cover
- Hand stitched
- Color Options: 177 - WH/GO/OR

1376985 Specify Size **\$39.99** EA



PITCH TEAM

- Traditional 32-panel design for accurate ball flight
- Machine-stitched TPU casing for consistent play
- High-contrast graphics for easy visual tracking

NKSC3166 Specify Size **\$19.99** EA



MacGregor
MATCH 32

- Quality laminated PU cover
- Butyl bladder for maximum air retention
- Foam backing for improved feel
- NFHS approved

1390104 Size 5 **\$27.99** EA ★



MacGregor
EQUALIZER

- High Gloss Laminated TPU Cover
- Foam backing for softer feel
- Butyl Bladder for maximum air retention

1390103 Size 5 - Purple **\$22.99** EA ★
1390102 Size 4 - Orange **\$22.99** EA ★
1390101 Size 3 - Green **\$22.99** EA ★



MacGregor
MERCURY CLUB

- Soft PVC cover
- Machine stitched
- Butyl bladder

70200235 Size 5 - Silver/Black/Orange **\$17.99** EA ★
70200234 Size 4 - Silver/Black/Green **\$17.99** EA ★
70200233 Size 3 - Silver/Black/Blue **\$17.99** EA ★



MacGregor
CLASSIC 32

- Long lasting, sewn synthetic cover
- 32 panel ball with butyl bladder
- 2-ply backing

MCS30005 Specify Size **\$15.99** EA ★

BSN SPORTS

YMCA HERITAGE

- Soft PVC cover
- Machine stitched

1384325 Size 5 - Silver **\$14.99** EA ★
1384326 Size 4 - Black **\$14.99** EA ★
1384327 Size 3 - Red **\$14.99** EA ★

SELECT PACKS



BRILLIANT SUPER - 6/PACK

- Teijin microfiber PU cover with 3 layer underlining
- Patented zero wing latex bladder
- 32 hand crafted panels that ensures true flight
- NFHS/NCAA/FIFA Approved
- Color: White/Black/Silver/Gold
- Includes ball bag

3 Year Limited Warranty



1388095 Size 5 \$559⁹⁹ PACK



ROYALE - 10/PACK

- NFHS/ NCAA approved – Hand Sewn
- 1.8 mm PU cover with zero wing latex bladder
- Includes ball bag

3 Year Limited Warranty

Color Options: **White, White/Black, White/Green, White/Maroon, White/Orange, White/Red, White/Royal, White/Yellow.**



1393301 Size 5 - Specify Color \$519⁹⁹ SET



NUMERO 10 - 10/PACK

- NFHS/ NCAA approved – Hand Sewn
- 1.5 mm PU cover with zero wing latex bladder
- Includes player # panel
- Includes ball bag
- All White & Yellow/Orange available in size 4 & 5
- Wht/Black, Wht/Red, Wht/Orange, Wht/Royal, Wht/Green available in size 5

2 Year Limited Warranty

Size: **4, 5**

Color Options: **Orange, White, White/Black, White/Green, White/Orange, White/Red, White/Royal, Yellow/Orange.**

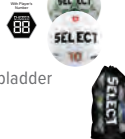

1393310 Specify Size/Color \$339⁹⁹ SET



THOR - 10/PACK

- Meets NFHS & NCAA regulations - Hand Sewn
- 1.0 mm PU cover with zero wing bladder
- Includes players # panel
- Includes ball bag

2 Year Limited Warranty

Size: **4, 5**

Color Options: **White/Black.**

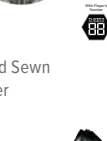

1393320 Specify Size \$289⁹⁹ SET



CLUB - 10/PACK

- The best practice ball on the market for the price
- 0.6 mm PU cover with zero wing latex bladder
- Includes players # panel
- Includes ball bag
- All White available in size 3, 4 & 5
- Wht/Black, Wht/Red, Wht/Orange, Wht/Green, Wht/Royal, Yellow/Red available in size 5

1393323 Specify Size/Color \$249⁹⁹ SET



TARGET DB - 10/PACK

- Dual bonded - machine stitched with heat activated glue bonding
- PU textured laminated panels with 3.5 mm thick foam
- SR bladder for excellent air retention
- Includes ball bag
- Color: Wht/Black/Orange

2 Year Limited Warranty

1399709 Size 5 \$329⁹⁹ SET



UNITED - 24/PACK

- 24 training balls with player # panel – Hand Sewn
- 0.6mm PU cover with butyl bladder
- Includes ball bag

Size: **3, 4, 5.**

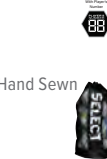

1393333 Specify Size \$489⁹⁹ SET



BRILLIANT SUPER REPLICA - 10/PACK

- Premium camp or recreational ball
- New PVC-composite with improved softness
- Butyl bladder for long air retention
- Includes ball bag
- Includes 5 yellow and 5 orange balls

Size: **3, 4, 5.**



1393337 Specify Size \$199⁹⁹ SET



TEAM - 10/PACK

- NFHS Approved - hand sewn
- 1.1mm PU cover with zero wing bladder
- Includes player # panel
- Includes ball bag
- Color: Yellow/Blue

1395066 Size 5 \$299⁹⁹ PACK



FUTSAL MAGICO - 6/PACK

- FPUS 1100 synthetic leather with optimized underlining
- Low bounce for perfect control
- Hand sewn 32 panel for perfect flight
- Includes ball bag

Size: **Junior, Senior**



1395120 Specify Size \$179⁹⁹ SET



OVER-VEST TRAINING BIB - SET OF 12/COLOR

- Comfortable and cost efficient 100% ploy mesh
- Horizontal panel is convenient for logo screening

Color Options: **Blue, Green, Orange, Pink, Red, Yellow**

Size: **Junior, Senior**

1375351 Specify Color/Size \$75⁹⁹ DZN



DIAMOND - 10 PACK

- Hand-sewn PU cover
- New backing layer provides softer feel and touch
- Patented Zero-Wing latex bladder
- Includes 10 balls and 1 ball bag
- IMS Approved

2 Year Limited Warranty

Color Options: **Blue, Maroon, Orange**

1390116 Size 5 - Specify Color \$259⁹⁹ SET

Bid #ESCNJ 17/18-31

Educational Services Commission of New Jersey

Athletic Equipment & Supplies

RUBBER/SYNTHETIC

SOCCER



Voit RUBBER BALL

- Waterproof for fun outdoor play
- Size: 3, 4, 5.

VCS33XXX Specify Size \$11.49 EA ★



MacGregor RUBBER BALL

- Best value playground soccer ball anywhere
- Extended-life molded construction
- Size: 3, 4, 5.

MCSBR5XX Specify Size \$10.29 EA ★



MacGregor MOLDED SYNTHETIC

- Nylon wound to ensure shape retention
- Stay-round and inflated butyl bladder
- Size: 3, 4, 5.

MCLS303X Specify Size \$17.99 EA ★

FUTSAL



SELECT FUTSAL MAGICO

- FPUG 1100 synthetic grain PU material
- Low bounce for perfect control
- Butyl bladder for better air retention
- Senior & Junior size available
- Size: Junior, Senior.

1388113 Specify Size \$31.99 EA



BRINE EVOLUTION FUTSAL

- Soft, durable PU cover
- Hybrid Panel Technology with low-bounce butyl bladder

1390140 Size Sr. \$27.99 EA



MacGregor LIMITED

- PVC soft cover
- Machine stitched

1262698 Size Sr. \$19.99 EA ★

INDOOR



BRINE EVOLUTION COURT

- Suede microfiber PU cover for indoor play
- Hybrid Panel Technology

1390138 Size 5 \$27.99 EA



MacGregor EUROFELT INDOOR

- Felt cover construction

MCSFELT5 Size 5 \$26.49 EA ★



Voit INDOOR FELT

- Nylon wound, molded felt cover
- Soft kick feel for virtually painless play

VSBMFL5 Specify Size \$23.99 EA ★

HEX NETS

SOCCER NETS

SQUARE MESH



ORANGE



WHITE

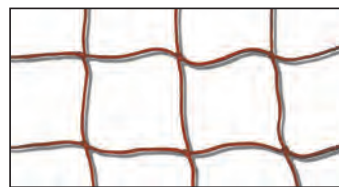

CODE	SIZE	BODY	RECOMMENDED USE	COLOR	PRICE
SN383PROY	8'H x 24'W x 5'D x 10'B	5.0 mm braided PE	College & Pro	Orange	\$279 ⁹⁹ PR ★
SN383PROW	8'H x 24'W x 5'D x 10'B	5.0 mm braided PE	College & Pro	White	\$279 ⁹⁹ PR ★
1248876	8'H x 24'W x 4.5'D x 10'B	4.0 mm braided PE-Hexagonal	College & Pro	Black/White	\$279 ⁹⁹ PR ★
1397773	8'H x 24'W x 3'D x 8.5'B	4.0 mm braided PE-Hexagonal	College & Pro	Black/White	\$259 ⁹⁹ PR ★
1367770	8'H x 24'W x 3'D x 5'B	4.0 mm braided PE-Hexagonal	College & Pro	Black/White	\$249 ⁹⁹ PR ★
1367769	8'H x 24'W x 3'D x 8.5'B	4.0 mm twisted knotted PE	College & Pro	White	\$249 ⁹⁹ PR ★
1367768	7'H x 21'W x 3'D x 7.5'B	4.0 mm twisted knotted PE	Club/Recreational	White	\$209 ⁹⁹ PR ★
1367767	6.5'H x 18.5'W x 2'D x 7'B	4.0 mm twisted knotted PE	Club/Recreational	White	\$179 ⁹⁹ PR ★
1367766	6.5'H x 12'W x 2'D x 7'B	4.0 mm twisted knotted PE	Club/Recreational	White	\$159 ⁹⁹ PR ★
1054729	8'H x 24'W x 4'D x 8'B	3.0 mm twisted knotted PE	High School/Club	White	\$229 ⁹⁹ PR ★
1054678	7'H x 21'W x 4'D x 8'B	3.0 mm twisted knotted PE	Club/Recreational	White	\$174 ⁹⁹ PR ★
1054682	6.5'H x 18.5'W x 3'D x 6'B	3.0 mm twisted knotted PE	Club/Recreational	White	\$164 ⁹⁹ PR ★
1054699	6.5'H x 12'W x 3'D x 6'B	3.0 mm twisted knotted PE	Club/Recreational	White	\$144 ⁹⁹ PR ★
1367772	4.5'H x 9'W x 2'D x 4.5'B	3.0 mm twisted knotted PE	Club/Recreational	White	\$129 ⁹⁹ PR ★
1367771	4'H x 6'W x 2'D x 4'B	3.0 mm twisted knotted PE	Club/Recreational	White	\$114 ⁹⁹ PR ★
SN383SNRY	8'H x 24'W x 5'D x 10'B	3.0 mm twisted PE	High School/Club	Orange	\$134 ⁹⁹ PR ★
SN383SNRW	8'H x 24'W x 5'D x 10'B	3.0 mm twisted PE	High School/Club	White	\$134 ⁹⁹ PR ★
1033526	8'H x 24'W x 5'D x 10'B	2.5 mm twisted PE	Recreational	Orange	\$109 ⁹⁹ PR ★
SN383ECOW	8'H x 24'W x 5'D x 10'B	2.5 mm twisted PE	Recreational	White	\$104 ⁹⁹ PR ★



SPIKE WITH CABLE LANYARD

- 14" galvanized spike
- 4 per goal required

SGSPIKE \$29⁹⁹ EA ★



TWIST-IN NET HOOKS

- Color: White

STNETCLIP \$0.75 EA ★
STNETCLIP \$34⁹⁹ 50/SET ★



HOOK & LOOP NET STRAPS

- 16" straps for 3" diameter and larger items
- 11" straps for 2" diameter and smaller items

1033502 White - 16" \$47⁹⁹ SET OF 24 ★
1368869 White - 11" \$37⁹⁹ SET OF 24 ★



SCREW-IN NET HOOKS

- Set of 50

MSBNETHK \$29⁹⁹ SET OF 50 ★

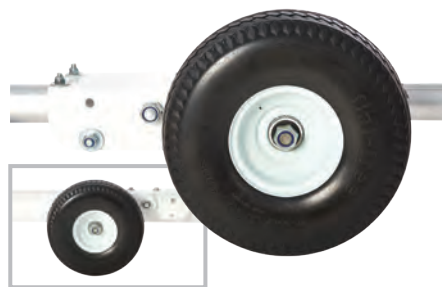

FLIP OVER WHEEL SET

- NO-FLAT wheels attach to any backstay up to 2" O.D.
- Compatible with all Alumagoal soccer goals (SGA400, SGA401, SGA402, SGA403 and all 3" Round Classic Club goals)
- Sold in sets of (2) wheels
- Two sets are required

SCGWHLXX \$179⁹⁹ SET OF 2 ★

PERMANENT GROUND ANCHORS

- 12" long; 2" O.D galvanized steel
- 4 anchors per goal required

ZSTSPANCHX

\$29⁹⁹ EA ★



AUGER STYLE GROUND ANCHOR

- 12" long; 12 mm O.D. galvanized steel rod
- 4 anchors per goal

SGAUGER

\$20⁹⁹ EA ★



SAND BAGS

- Holds 50 lbs. of sand (not included)
- Heavy duty pvc handle for easy carrying

1336542 22" x 15" \$74⁹⁹ SET OF 4 ★



FREE NETS & GROUND ANCHORS INCLUDED

ALUMAGOAL®

4" ROUND CLASSIC ALUMAGOAL

- Official size 8'H x 24'W x 3'D x 9'B
- Meets NCAA, NFSHSA and FIFA specs
- Front face is 4" round, powder coated custom aluminum extrusion for superior strength
- Backstays are 2" round powder coated aluminum
- Rear crossbars are 2" round galvanized steel
- Built-in net clip track with clips
- Includes 4mm white nets and ground anchors
- 360 lbs./pr



GROUND ANCHOR ATTACHMENT



*** WHEEL KIT CAN BE ADDED**



ROUND DESIGN SHOWING NET CLIP TRACK

SGA400	Complete Unit	\$2,899 PR ★ S&H
SCGWHLXX	Flip Over Wheel Kit - 1 Pr/Set	\$179 SET ★
1367769	4mm - Replacement Net	\$249 PR ★



ALUMAGOAL®

FOOTBALL/SOCCER COMBO GOAL

- Meets High School soccer and football regulations
- 10'H football uprights are constructed of 2" square aluminum tubing
- Width of uprights can be adjusted for H.S. (23'4") or Collegiate (18'6") play or removed for soccer play
- Soccer goal size - 8'H x 24'W x 3'D
- Soccer post are constructed of 1 1/2" diameter 2" x 4" steel tubing
- Crossbars are constructed of 1 1/2" diameter 2" x 4" steel tubing
- Two-piece engineered crossbar for increased ease of shipping and installation

- Euro style backstays are constructed of 14 gauge - 1.5" steel tubing
- Extremely corrosion resistant galvanized and white powder coated finish
- Goals include backstays, 4mm soccer nets, net fasteners and ground stakes
- Optional Ground Sleeves available for semi-permanent installation

SGFBCOM
156769
1308082

1 Pair of Goals - Includes Nets
4mm - Replacement Net
Ground Sleeves - 4/Set

\$2,899 PR ★ **S&H**
\$179 SET ★
\$249 PR ★

NJ State Approved Co-op #65MCECCPS Metuchen/Garden State AppareBid Term: 5/9/18 - 5/8/20: Extended to 5/18/21



ALUMGOAL®



**NATURAL ALUMINUM
FREE NETS & GROUND ANCHORS INCLUDED**



**HEAVY WALL BOTTOM BAR
ON 12', 18.5', 21' AND 24' MODELS**



**NET CLIP TRACK IN TOP
& SIDE FRAMES**



SOCCER GOAL SAFETY PADDING

- Meets NFSHA rule regarding safety padding
- Fits 2" x 4", 4" x 4" and 3" x 4" round soccer goals
- High density 1" thick foam covered in white vinyl coated nylon
- Hook & loop fasteners attached
- 1 pair per goal

3" ROUND CLASSIC CLUB GOALS

- Front face is 3" round custom aluminum extrusion
- Available in White (Powder Coated) or Natural Aluminum
- Built in net clip track
- Backstays are 2" round heavy wall aluminum tubing
- Double reinforced Tig welded corners
- Stainless steel hardware
- Includes 4mm White Net, Net Clips and Ground Anchors
- Includes Back Bottom Bar (24', 21', 18.5' & 12' models only)
- Meets NFSHA specs (8' x 24' SGA300 model only)
- 5 Year Limited Warranty

NATURAL ALUMINUM 3" ROUND CLUB GOALS

SGA320	8'H x 24'W x 3'D x 8.5'B - 330 lbs./pr.	\$2,199⁹⁹ PR ★ S&H
SGA321	7'H x 21'W x 3'D x 7.5'B - 301 lbs./pr.	\$2,099⁹⁹ PR ★ S&H
SGA322	6.5'H x 18.5'W x 2'D x 7'B - 260 lbs./pr.	\$1,899⁹⁹ PR ★ S&H
SGA323	6.5'H x 12'W x 2'D x 7'B - 208 lbs./pr.	\$1,699⁹⁹ PR ★ S&H
SGA324	4'H x 6'W x 2'D x 4'B - 118 lbs./pr.	\$1,199⁹⁹ PR ★ S&H



ALUMGOAL®



SOCCER

**WHITE POWER-COATED
FREE NETS & GROUND ANCHORS INCLUDED**



3" ROUND CLASSIC CLUB GOALS

- Front face is 3" round custom aluminum extrusion
- Available in White (Powder Coated) or Natural Aluminum
- Built in net clip track
- Backstays are 2" round heavy wall aluminum tubing
- Double reinforced Tig welded corners
- Stainless steel hardware
- Includes 4mm White Net, Net Clips and Ground Anchors
- Includes Back Bottom Bar (24', 21', 18.5' & 12' models only)
- Meets NFSHSA specs (8' x 24' SGA300 model only)
- 5 Year Limited Warranty



POWDER-COATED WHITE 3" ROUND CLUB GOALS

SGA300	8' H x 24' W x 3' D x 8.5' B – 330 lbs./pr.	\$2,399⁹⁹ PR ★
SGA301	7' H x 21' W x 3' D x 7.5' B – 301 lbs./pr.	\$2,299⁹⁹ PR ★
SGA302	6.5' H x 18.5' W x 2' D x 7' B – 260 lbs./pr.	\$2,099⁹⁹ PR ★
SGA303	6.5' H x 12' W x 2' D x 7' B – 208 lbs./pr.	\$1,899⁹⁹ PR ★
SGA304	4.5' H x 9' W x 2' D x 4.5' B – 134 lbs./pr.	\$1,499⁹⁹ PR ★
SGA305	4' H x 6' W x 2' D x 4' B – 118 lbs./pr.	\$1,399⁹⁹ PR ★



HEAVY DUTY BACK BOTTOM BAR ON 12', 18.5', 21' AND 24' MODELS

NETS, CLIPS AND GROUND ANCHORS INCLUDED

5/8/21

ALUMAGOAL®



MANCHESTER MATCH GOAL

- Official size 8'H x 24'W x 3'D x 9'B
- Meets NCAA, NFSHSA and FIFA specs
- Crossbars and posts are 4" round, powder coated custom aluminum extrusion for superior strength
- Backstays are 2" round powder coated aluminum
- Double reinforced tig welded corners
- Built-in net clip track with clips
- Stainless steel hardware
- Includes 4mm Black/White hexagonal nets, sand bag anchors and transport wheels
- 480 lbs. Per Pair



**FEATURES:
NET CLIP TRACK IN TOP,
SIDE AND BOTTOM FRAMES**



**NET CLIPS INCLUDED
FAST SETUP & TAKEDOWN**



**ROUND DESIGN
SHOWING NET CLIP TRACK**

\$4,499⁹⁹

SGA402 ★ Complete Unit

\$259⁹⁹

1397773 ★ Replacement Net



FLIP OVER WHEELS FOR EASY TRANSPORT

ALUMAGOAL

SOCCER



4" EURO STADIUM ALUMAGOAL

- Official size 8'H x 24'W x 3'D x 9'B
- Meets NCAA, NFSA and FIFA specs
- Crossbars and posts are 4" round, powder coated custom aluminum extrusion for superior strength
- European backstays are 2" round powder coated aluminum
- Double reinforced tig welded corners
- Built-in net clip track with clips
- Stainless steel hardware
- Includes 4mm Black/White, half depth hexagonal nets and sand bag anchors
- 380 lbs. Per Pair



\$3,799⁹⁹

SGA403 ★ Complete Unit

1367770 ★ Replacement Net

\$249⁹⁹



4" EURO ALUMAGOAL

- Official size 8'H x 24'W x 3'D x 9'B
- Meets NCAA, NFSA and FIFA specs
- Crossbars and posts are 4" round, powder coated custom aluminum extrusion for superior strength
- European backstays are 2" round powder coated aluminum
- Double reinforced tig welded corners
- Built-in net clip track with clips
- Stainless steel hardware
- Includes full depth 4mm white nets and sand bag anchors
- 380 lbs. Per Pair

\$3,799⁹⁹

SGA401 ★ Complete Unit

1367769 ★ Replacement Net

\$249⁹⁹

NJ State Approved Co-op #65MCECCPS

Metuchen/Garden State Apparel Bid Term: 5/9/18 - 5/8/20: Extended to 5/8/21



ALL PURPOSE BACKSTOP SYSTEM

- Backstop system measures 21'H x 65'W
- Constructed with (4ea) 3.5" galvanized 11 guage steel poles
- Choice of 3mm 4" mesh or 1.75" mesh (275 lb. breaking strength)
- Easy on and off pulley system and (4ea) galvanized steel ground sleeves
- Weight: 360 lbs.

1071436	System with 4" Netting	\$1,899 ⁹⁹	EA	★
1071435	System with 1 3/4" Netting	\$2,399 ⁹⁹	EA	★
1249071	Replacement Net - 4" Mesh	\$399 ⁹⁹	EA	★
1072230	Replacement Net - 1 3/4" Mesh	\$799 ⁹⁹	EA	

BALL BOUNDARY SYSTEM

- Complete 12' high system with poles and netting
- Posts are constructed of 2 3/8"D x 3/16" wall aluminum tubing
- Ground Sleeves are aluminum with rubber caps
- Top and Bottom of Net is supported by nylon coated galvanized cable
- 1 3/4" 3mm braided knotless EHT black net
- Posts are spaced 20' apart
- Please allow 3 - 4 weeks for delivery

BBS12A	12'H System - Complete	\$27 ⁹⁹	FT	★	
BBSNET12	12'H Replacement Net	\$8 ⁴⁹	LF		



OFFICIAL COMPETITION FUTSAL GOAL

- Full aluminum construction
- White powder coated goal face with built-in net clip track
- Includes 4mm white net and non marring floor protectors

FGA500
1273489

77"H x 9'10"W x 2'8"D x 3'4"B - 185 lbs/pr
Replacement Net - 4mm

~~\$1,699~~ ⁹⁹ PR ★ **S&H**
~~\$149~~ ⁹⁹ PR ★



PORTABLE/FOLDABLE INDOOR SOCCER GOAL

- Goal measures 6.5'H x 12'W x 5'D
- 2" square steel powder coated face
- Both backstays fold inward for storage
- Non-marking floor pads are on each of the 4 contact points
- 3mm white net
- Weight: 174 lbs. per pair



SCGOAL5A
SCGOAL5B
SCNET5

2 Goals with Nets
Replacement Net

~~\$699~~ ⁹⁹ PR ★ **S&H**
~~\$199~~ ⁹⁹ EA ★

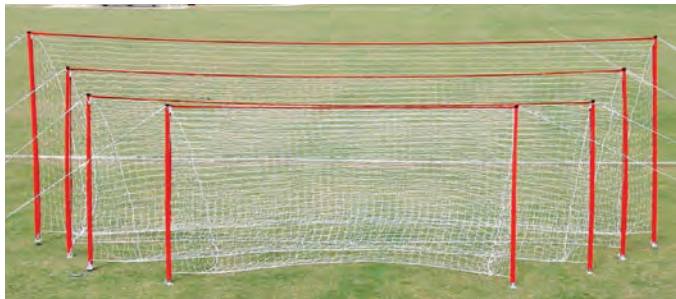

SOCCER INNOVATIONS

J-GOAL

- Completely portable soccer goals
- Telescoping support poles, pre-attached net and quick connect cords
- Converts to high or low soccer tennis
- Includes carry bag and ground spikes

1366511	8'H x 24'W - 14 lbs.	\$249 ⁹⁹ EA
1366516	7'H x 21'W - 12 lbs.	\$239 ⁹⁹ EA
1366517	6'H x 18'W - 12 lbs.	\$229 ⁹⁹ EA
1366527	6'H x 12'W - 12 lbs.	\$219 ⁹⁹ EA

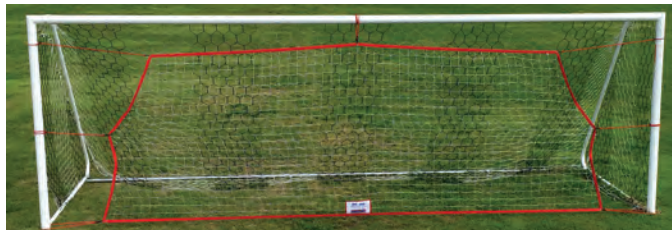

SOCCER INNOVATIONS

PK PRO - SNIPERS NET

- Fits full size 8'H x 24'W goal
- Replace your goalkeeper in drills and scrimmages
- Use for any finishing drill or rebound training
- Includes net, bungee straps and carry bag

1366518	\$169 ⁹⁹ EA
---------	------------------------



FLEX SPRING BASE



WEIGHTED BASES AND WHEELS

SOCCER INNOVATIONS

SOCCER WALL™ MAN

- Includes (4) Collapsing Soccer Wall Mannequins
- Lightweight and wind resistant
- Body design deflects balls keeping the Mannequin upright
- PVC Pole clicks on and off and flex's when hit
- Ground spike version includes Flex Spring Base, Carry Bag, Drill Sheet and Soccer Tennis Net
- Weighted base version includes Field Turf Base that can be filled with sand or water for added weight (carry bag and soccer tennis net not included)

1306286	Set of 4 w/Weighted Base and Wheels	\$599 ⁹⁹ SET ★
1393355	1 Each w/Weighted Base and Wheels	\$149 ⁹⁹ EA
1306279	Set of 4 w/Ground Spikes	\$469 ⁹⁹ SET ★
1393356	1 Each w/Ground Spikes	\$109 ⁹⁹ EA



TRAINER / REBOUNDER GOAL

- Net can be adjusted for rebound, used for shooting skills, finishing skills or splitting one field into two
- Made of 1 7/8" diameter heavy wall aluminum tubing
- Spring button assembly requires no tools
- 30" steel anchoring shoes with permanent spikes
- 3mm 4" polyethylene net and carrying bag

1150858	7'H x 21'W	\$579 ⁹⁹ EA ★	SAH
1366835	Optional All Surface Shoe	\$149 ⁹⁹ PR ★	

Bid #ESCNJ 17/18-31

Educational Services Commission of New Jersey

Athletic Equipment & Supplies



PUGG® SOCCER GOAL

- Great for soccer training, as well as field or floor hockey practice
- Pop-up design allows for quick and easy set up
- Anchoring pegs included to secure the goal to the ground
- Includes two goals, anchoring pegs and a storage bag

1277180	Yellow/Black - 30"W x 24"H x 22"D	\$74⁹⁹ PR
1063943	Royal - 48"W x 32"H x 32"D	\$109⁹⁹ PR
1063936	Gold - 72" W x 42"H x 42"D	\$149⁹⁹ PR

BSN SPORTS



POP UP SOCCER GOAL

- Nylon net with fiberglass poles (2-pack)
- Ground stakes - attached to the net
- Pop-up design offers quick set-up and take-down
- Includes a carry bag for transport and storage

1393444	Royal - 30"W x 20"H x 18"D	\$59⁹⁹ PR ★
1393445	Red - 48"W x 38"H x 36"D	\$79⁹⁹ PR ★
1393446	Black - 72"W x 48"H x 48"D	\$99⁹⁹ PR ★

SOCCER



UPWARD SPORTS

LIL' SHOOTER 2 GOAL

- Constructed of 1.312" O.D. galvanized steel tubing
- Includes 3mm 1.75" net with hook-and-loop fasteners
- Folds for easy portability and storage

1248807	4'H x 6'W x 2.5'D	\$309⁹⁹ PR ★
1248814	Replacement Net	\$82⁹⁹ PR ★



LIL' SHOOTER GOAL

- Made of 1.25" O.D. steel tubing with silver powder coated finish
- Includes 2mm nets with sewn in hook-and-loop fasteners
- Goal is foldable for easy portability to and from field

1150872	4'H x 6'W x 4'D	\$65⁹⁹ EA ★
1150889	5'H x 10'W x 5'D	\$85⁹⁹ EA ★
1150896	Replacement Net 4' x 6'	\$23⁹⁹ EA ★
1150902	Replacement Net 5' x 10'	\$29⁹⁹ EA ★



FREE CARRY BAG

CARRY GOAL

- 8'H x 24"W goal, convenient carry bag, 4 ground stakes and one full size weather resistant net
- Constructed of 2" extra-strong aluminum tubing
- Fast break-down and convenient portability with a 3-piece front crossbar system
- Optional all-surface conversion shoes available. 2/pr required per goal
- Weight: 60 lbs.

STSGPTB6	Goal & Net	\$659⁹⁹ EA ★	SAH
1366835	Optional All-Surface Shoes	\$49⁹⁹ EA	



PORTABLE SOCCER GOAL

- Rigid steel and fiberglass pole patented design
- No tools needed
- Assembles in minutes
- Tear resistant nylon netting
- Free carry case included

1297461	3'H x 5'W	\$129⁹⁹ EA
1394974	4'H x 6'W	\$189⁹⁹ EA
1297478	4'H x 8'W	\$199⁹⁹ EA
1297485	5'H x 10'W	\$329⁹⁹ EA
1297492	6'H x 12'W	\$359⁹⁹ EA
1305746	7'H x 14'W	\$399⁹⁹ EA
1305753	6.5'H x 18'W	\$459⁹⁹ EA
1315882	8'H x 24'W	\$749⁹⁹ EA



FUN FOR ALL AGES AND SKILL LEVELS

FUNNETS™ are made of a unique blend of materials designed specifically for outdoor use. Our heavy body construction is UV treated and is unbreakable. We know you have seen the imitation PVC plastic goals which are made of tubing designed for plumbing applications. These imitation goals have a very low impact resistance which can cause the piping to break and expose sharp edges.

Our **5 Year Unlimited Warranty** is the best in the industry.

DON'T BE FOOLED BY CHEAP IMITATIONS!

SPORTSTUFF® ROD

Our engineers searched for the perfect blend of flex/strength ratio. The result was the Sportstuff® rod. A safe, unbreakable rod with UV stabilizers, that lasts a lifetime!



FUNNETS® FITTINGS

The Funnet® fitting is molded out of ABS plastic with UV stabilizer for long life and strength. The fittings are longer for a more secure fit. Each fitting has set screws which allow the fitting to be tightened securely to the rod.



EASY TO CARRY AND TRANSPORT

FUNNET® GOALS

- 1 5/8" O.D. heavy duty rods and indestructible ABS fittings
- Comes complete with 3mm blue net

1. 3'H X 4'W X 1.5'D

1150056	Goal w/Net - 1 Each	\$119.99 EA ★
1150070	Replacement Net - 3mm, Blue	\$19.99 EA ★

2. 4'H X 6'W X 2'D

1150025	Goal w/Net - 1 Each	\$139.99 EA ★
1150049	Replacement Net - 3mm, Blue	\$27.99 EA ★

3. 6'H X 8'W X 3'D

1149982	Goal w/Net - 1 Each	\$179.99 EA ★
1150018	Replacement Net - 3mm, Blue	\$42.99 EA ★

4. 7'H X 10'W X 5'D

1249095	Goal w/Net - 1 Each	\$239.99 EA ★ S&H
1162356	Replacement Net - 3mm, Blue	\$49.99 EA ★



FUNNET® GOAL 7'H X 10'W X 5'D (ALUMINUM)

- 1.9" O.D. tubular aluminum
- Goal will not rust
- Comes complete with 3mm blue net

Bid #ESC NJ 17/18-31

Educational Services Commission of New Jersey

Athletic Equipment & Supplies

SOCCER

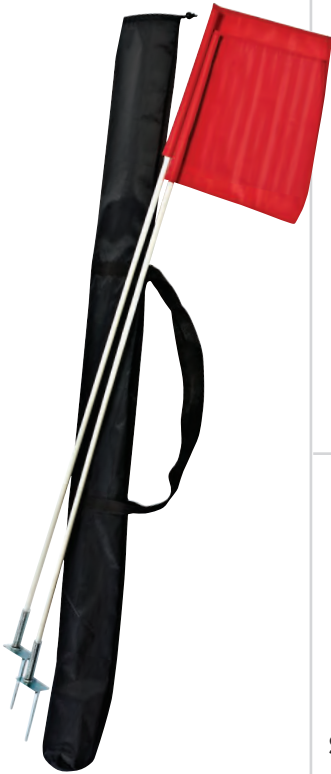

CORNER FLAG CARRY BAG

- Carries corner flags or coaching sticks
- Black Only

1366514 70"L x 7"W \$14.99 EA ★

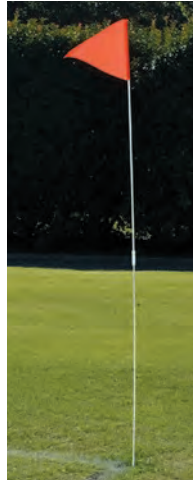

FIBERGLASS CORNER FLAGS

- Extra durable and light weight
- Two piece pole
- 4 Flags/Set

20012999 60"H \$39.99 SET ★

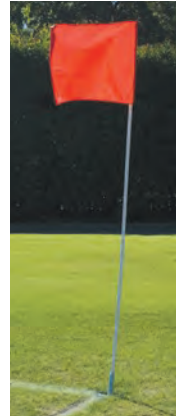

FLEXIBLE CORNER FLAGS

- One piece construction
- 1/2" flexible PVC upright
- Steel spring base with ground stake
- 4 Flags/Set

MSSOCFLG1 Poles w/Flags - 60"H \$59.99 SET ★
1393451 Replacement Flag (4/Set) \$12.99 SET ★

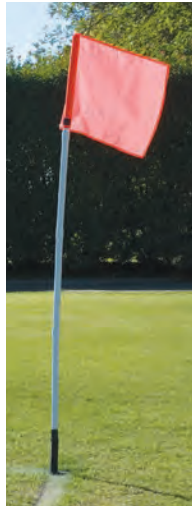

SEGMENTED CORNER FLAGS

- 4-section 1" PVC material
- Bottom section is inserted and glued to the spring
- All 4-sections are connected by an interior 3mm cord, so pieces are not lost when disconnected
- 4 Flags/Set - Carry bag included

1238624 72"H \$82.99 SET ★

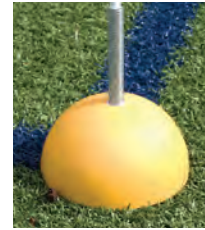

INDOOR/OUTDOOR CORNER FLAGS

- Can be used on turf surfaces
- Uses a spring loaded dome base
- Base must be filled with sand
- 4 Flags/Set

1251838 60"H \$69.99 SET ★



SPRING LOADED SOCCER CORNER FLAGS

- Spring loaded corner flags that "give" when contacted by a player and return upright automatically
- 2-Piece 1.33" O.D. PVC poles
- High visibility orange flags

- Includes: 4 flags with ground sockets with plugs, installation accessory kit and storage bag.

MK4X4S 60"H \$169.99 SET

- Includes: 6 flags with ground sockets with plugs, installation accessory kit and storage bag.

MK6X6S 60"H \$229.99 SET

- Includes: 6 flags and storage bag. Ground sockets not included.

MK6FB 60"H \$169.99 SET

MKA101 Ground Socket with Plug \$9.99 EA

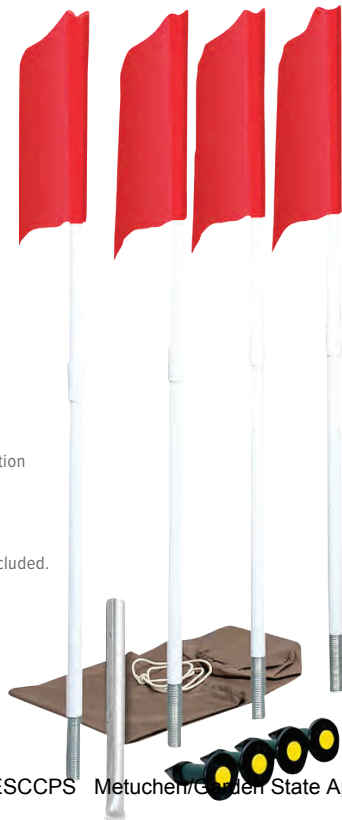

REFLEX SOCCER CORNER FLAGS

- Reflex corner flag
- 1-Piece 1.33" O.D. PVC poles
- High visibility orange flags

- Includes: 4 flags with ground sockets & plugs and installation accessory kit. Storage bag not included

MK4RFGSP 66"H \$149.99 SET

- Includes: 6 flags with ground sockets & plugs and installation accessory kit. Storage bag not included.

MK6RFGSP 66"H \$194.99 SET

- Includes: 4 flags and storage bag. Ground sockets not included.

MK4FB 66"H \$134.99 SET

MKA101 Ground Socket with Plug \$9.99 EA





**SKLZ»
QUICKSTER SOCCER TRAINER**

- Provides a true-roll that helps master passing and receiving on ground
- Maximize reps by trapping the ball out of the air with your feet, thighs and chest
- Work on volleys and half volleys with instep and laces
- Shoots ball into the air for downward offensive headers and defensive headers up and away
- Portable, lightweight and stores easily
- Large sided net measures 4'H x 6'W and the small sided net measures 20"H x 6'W
- Includes carry bag and 4 ground stakes

1393074 4'H x 6'W - 11 lbs. **\$119⁹⁹** EA



**SKLZ»
PRO TRAINING AGILITY POLES**

- Multiple training options with reversible spike
- Unique design works on grass, turf and courts when combined with our Pro Training Utility Weight
- Design allows for three different heights settings— 24 inches, 45 inches and 60 inches
- Set includes 8 Pro Training Agility Poles with protective caps, 125 mm detachable spikes and a convenient carry bag

1393278 Agility Poles (Set of 8) **\$79⁹⁹** SET
1393360 Utility Weights (Set of 2) **\$49⁹⁹** PR



PASSING ARCHES

- Great for training
- Can be used as a goal for small-sided games
- Improve passing and dribbling or use as part of an obstacle course
- Plastic tubing with metal ground stake

1306132 Set of 12 **\$79⁹⁹** SET



LOW PROFILE CONES

- Soft, flexible and stack easily
- Color code your drills for more effective practice time
- Available in Orange, Yellow or Prism Packs (2 each: Blue, Green, Orange, Purple, Red and Yellow)
- 3"H x 7 3/4" diameter

1255706 Orange **\$13²⁹** DZN ★
1276558 Yellow **\$13²⁹** DZN ★
1255690 Prism Pack **\$13²⁹** DZN ★

LOW-PROFILE CONES WIRE CARRIER

- Holds up to 60 low-profile field cones (cones not included)
- Easy carry and storage

93095XXX **\$5⁰⁹** EA ★



ECONOMY CONES

- Lightweight vinyl with small base
- No hole in top

MSCONE9XY 9" **\$3⁰⁹** EA ★
MS12CONEY 12" **\$4⁰⁹** EA ★



ORANGE GAME CONES

- Flexible PVC with weighted base for added stability
- Stack easily for storage

1040814 12" **\$9¹⁹** EA ★
1040838 18" **\$11²⁹** EA ★
1040845 28" **\$30⁹⁹** EA
1040852SET 36" **\$214⁹⁹** SET OF 5



LARGE PROFILE CONES

- Soft-style - flexible and stackable
- Mix with low profile cones for various drills
- Approximately 6"H x 11" diam.

1279687 Orange **\$29⁹⁹** DZN ★
1336511 Yellow **\$16²⁹** DZN ★

Bid #ESC NJ 17/18-31

Educational Services Commission of New Jersey

Athletic Equipment & Supplies

SOCCER



Sport Write!
COACHING TOOLS

DRY-ERASE BOARDS

- Large format enables entire team to see play
- 2 writing surfaces
- Great pen clip with premium dry erase marker
- 12 1/2"H x 16 1/2"W - 2 lbs.

1366485 \$29⁹⁹ EA

BSN SPORTS

SOCCER OFFICIAL SCOREBOOK
22 LINES / 28 GAMES

SOCCER SCOREBOOK

- 22 lines, 28 games
- Includes schedule and team roster

MSSOCBOK \$6⁹⁹ EA

SOCCER COACH'S BOARD

- Front half field and back full field writing surfaces
- Includes premium dry erase marker
- 8"W x 15 1/2"L

1388110 \$13⁹⁹ EA ★



SOCCER SCOREBOOK

- Record statistics for 20 games
- Includes extra page for season totals

1336054 \$9⁹⁹ EA



TRAVEL CHAIR BENCH

- Portable, collapsible bench that sets up in seconds
- Made from high-density 600D polyester
- Comes with mesh pouch at one end of bench for storage
- Bench is rated to support up to 300 lbs. per seat
- Seat Height - 17"
- 6-Seater dimensions unfolded - (104"L x 19"W x 17"H)
- 3-Seater dimensions unfolded - (52"L x 19"W x 17"H)

1392979	6-Seater - Black	\$109 ⁹⁹ EA
1392980	6-Seater - Royal	\$109 ⁹⁹ EA
1392981	3-Seater - Black	\$69 ⁹⁹ EA



WARNING CARDS AND WALLET

- Vinyl wallet holds one red and one yellow 3" x 4" plastic warning card
- Cards included

MSREFWAL \$4⁹⁹ EA ★



LINESMAN FLAGS

- One red and one yellow 12" x 15" nylon flag
- 18" wood sticks with knob handles

MSLFECON \$9⁹⁹ PR ★

REFEREE/OFFICIALS WATCH

- Dual Independent Game Timers on one display
- One Counts down from full minutes, while the other counts up in 1/100 seconds
- Use the Countdown for the game time
- The Countup timer can be used for add on time
- Water resistant to 30 meters
- 50 memory recall Stopwatch with 1/100 second resolution
- User replaceable CR-2032 battery



1399653 SC-591 \$39⁹⁹ EA



SELECT CAPTAIN'S ARM BAND

- Velcro closure and extra elastic to keep in position on the arm

Color Options: **Black, Gold, Kelly, Neon Green, Neon Orange, Neon Yellow, Orange, Purple, Royal, Scarlet.**

1371625 Specify Color \$4⁹⁹ EA



NEW NEON COLORS!

LIGHTWEIGHT SCRIMMAGE VESTS

- Polyester mesh vest
- Reinforced neck and armholes
- Elastic waistband

Color Options: **Black, Gold, Kelly, Neon Green, Neon Orange, Neon Yellow, Orange, Purple, Royal, Scarlet.**

C46Y	K thru 3rd Grade	\$4 ⁹⁹ EA ★
C46	4th thru 6th Grade, Middle School & Up	\$6 ⁹⁹ EA ★
C47N	Adult (# 1-12) 60, AE, OR, PU, RO, SC, BK only	\$79 ⁹⁹ DZN ★



REVERSIBLE SCRIMMAGE VESTS

- Polyester mesh construction
- Reversible jerseys with elastic bottom

Color Options: **Dark Green/Gold, Orange/Gold, Red/Black, Royal/Gold, Royal/Red, Silver/Black.**

1262773 Youth \$77⁹⁹ DZN ★

Metuchen/Garden State Apparel Bid Term: 5/8/18 - 5/8/20: Extended to 5/8/21



PLASTIC SHIN GUARDS

- Practical shin guards with plastic foam backing

MCSG7WHS Youth - 7" \$3.99 PR ★
MCSG9WHS Adult - 9" \$4.49 PR ★



PADED SHIN GUARDS

- Stirrup design for ankle and shin protection
- Adjustable hook/loop strap

1276534 Youth - 7" \$15.99 PR ★
1276541 Adult - 9" \$15.99 PR ★



ADULT PADED SHIN GUARDS

- Cloth guard with padded ankle, stirrup and three plastic inserts
- Machine washable

MSSOCSHN Adult - 9" \$11.29 PR ★



GOALIE GLOVES - ADULT

- White latex foam palm for grip and durability
- Gusseted fingers for comfort and ball control
- Hook-and-loop closure

Size: **8, 9, 7, 10.**

MCSGLVA Adult: 7-10 \$25.99 PR ★



GOALIE GLOVES - YOUTH

- White latex foam palm for grip and durability
- Gusseted fingers for comfort and ball control
- Hook-and-loop closure

Size: **4, 5, 6.**

MCSGLVY Youth: 4-6 \$24.99 PR ★



KING MATCH 3X GOALIE GLOVES

- Backbone finger-protection technology prevents hyperextension and offers flexibility and comfort
- Mesh between fingers increases breathability
- Superior super-sticky latex foam for sure grip

Size: **6, 7, 8, 9, 10, 11.**

1388080 Specify Size 6 - 11 \$34.99 PR

SELECT



33 ALL ROUND GOALIE GLOVE

- All weather practice and match glove
- Flexible and good fit
- Non-removable flexible finger spines
- Flat Cut Palm with Dura Grip Latex
- Wide latex strap for greater support and easy adjustments

Size: **7, 8, 9, 10, 11.**

1395060 NJ State Approved Co-Op #65MCESSCP \$40.99
 1384350 Blue/White - Specify Size \$39.99 PR



88 PRO GRIP GOALIE GLOVE

- Professional lightweight match and elite training glove
- Flexible spines for added finger protection
- Flat Cut Palm
- Soft contact latex with grooves inside for grip
- Tight and comfortable glove
- Wide latex strap for greater support and easy adjustment

Size: **7, 8, 9, 10, 11.**

1395060 NJ State Approved Co-Op #65MCESSCP \$40.99
 1384350 Blue/White - Specify Size \$39.99 PR



33 HARDGROUND GOALIE GLOVE

- All weather practice and match glove
- Special rubbered latex palm for added durability
- Non-removable flexible spines
- Specially made for turf and hard ground surfaces
- Wrist closure with hook and loop strap

1395060 NJ State Approved Co-Op #65MCESSCP \$40.99
 1384360 Specify Size \$44.99 PR

Bid #ESCNJ 17/18-31

Educational Services Commission of New Jersey

Athletic Equipment & Supplies



FULL 90 PREMIER HEADGUARD

- Advanced Trufit 2™ System
- Force Bloc™ Foam
- Ultralight Construction
- Ball Plays True off Head
- Extended Occipital Coverage
- Extended Temporal Impact Absorption
- Cool Max™ Material
- Ponytail Port

Color Options: **Black, Navy, Red, Royal**
Size: **S/M, LRG.**

1377011 Specify Color & Size \$44.99 EA



HEAVY-DUTY MESH EQUIPMENT BAG

- Great for carrying and identifying equipment
 - 32" x 36" bag holds up to 12 balls
 - Includes clipping drawstring for easy and secure closure
- Color Options: **Black, Blue, Gold, Kelly, Orange, Purple, Red.**

SNBCNET 32" x 36" (Specify Color) \$11.19 EA ★
SNBCNETW 24" x 36" (White Only) \$8.19 EA ★



MATCH DAY BAG W/ 4 NUMERO 10'S

- Features four padded compartments with zippered mesh panels to keep game day balls in top condition
- Includes zippered small item pockets, a card organization system, clear i.d. holder, padded, removable shoulder strap and Velcro carry handles
- Includes (4) Numero 10 Soccer Balls (size 5)

1348583 \$69.99 EA ★
1348576 \$49.99 EA ★



TEAM ROLLER BAG

- 600 denier polyester shell
 - Concealed pull handle
 - Padded shoulder strap
 - In-line wheel kit
 - Oversized accessory pockets on both ends
- Color Options: **Black, Royal, Scarlet.**

1385400 38" L x 16" W x 15" H \$79.99 EA ★



LARGE DUFFLE EQUIPMENT BAG

- Durable 600 denier polyester bag with a thick web shoulder strap and handle
- Military style closure
- Black only

1385397 33" L x 18" W \$24.99 EA ★



TEAM DUFFLE BAG

- Zip close compartments on both ends
- Double handle carry straps
- Padded shoulder harness
- Denier nylon with breathable air vents
- Black only

1377672 27" L x 14" W x 12" H \$29.99 EA ★
1377675 24" L x 12" W x 10" H \$26.99 EA ★



TEAM EQUIPMENT BAG

- Heavy duty polyester equipment bag
- Rugged nylon zipper with wrap around handles
- Black only

1377678 33" L x 12" W x 15" H \$19.99 EA ★



NET BALL CARRIER

- Holds 8-12 volleyballs, soccer balls, basketballs, or footballs

1346400 \$9.99 EA ★



MESH BALL CARRIER

- Comes with shoulder strap, vinyl bottom and mesh top fabric

1346654 \$33.99 EA ★



CLASSIC ROUND POSTS

- Constructed of round tubular steel
- Powder coated finish
- Complete with brass winder and lacing bars
- Ground sleeves sold separately

3" Posts - Standard Height

1234404	Green	\$319 ⁹⁹ PR ★
1234411	Black	\$319 ⁹⁹ PR ★

2 7/8" Posts - Standard Height

1234428	Green	\$309 ⁹⁹ PR ★
1234435	Black	\$309 ⁹⁹ PR ★

GROUND SLEEVES

- Optional galvanized steel ground sleeves for Edwards Classic Round Post
- Sleeve plugs included

1235708	For 2 7/8" Posts	\$62 ⁹⁹ PR ★
1234473	For 3" Posts	\$69 ⁹⁹ PR ★



WIMBLEDON SQUARE POSTS

- Constructed from 3" square "box-section" steel
- Powder coated finish
- Complete with brass winder and lacing bars
- Ground sleeves sold separately

1234459	Green	\$339 ⁹⁹ PR ★
1234442	Black	\$339 ⁹⁹ PR ★

GROUND SLEEVES

- Optional galvanized steel ground sleeves for Edwards 3" Square Posts

1234480



BRASS WINDER UNITS

- Includes removable handle and screw

1. 1234527	Winder Unit - Round Post	\$149 ⁹⁹ EA ★
2. 1234534	Winder Unit - Square Post	\$149 ⁹⁹ EA ★
1234510	Handle Only	\$45 ⁹⁹ EA ★



EXTERNAL RATCHET POSTS - 2 7/8"

- 2 7/8"OD, powder coated steel
- Complete with ratchet, caps and pulley
- Safety ratchet has a detachable handle
- For permanent installation or semi-permanent (with optional ground sleeves)

TP278GRN	Standard Post - Green	\$189 ⁹⁹ PR ★
1263138	Standard Post - Black	\$189 ⁹⁹ PR ★

GROUND SLEEVES

- PVC ground sleeves for 2 7/8" external ratchet posts

1235678		\$62 ⁹⁹ PR ★
---------	--	-------------------------

REPLACEMENT SAFETY RATCHET

- Heavy-duty steel safety ratchet
- Will fit most existing posts

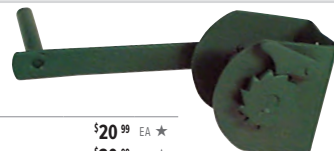

MTRT5XXX	Green	\$20 ⁹⁹ EA ★
1002430	Black	\$20 ⁹⁹ EA ★

POST CAPS

- Steel post cap and pulley
- Fits 2 7/8" post only



MTCAP278	Green	\$21 ⁹⁹ EA ★
1002485	Black	\$21 ⁹⁹ EA ★



10 & UNDER TENNIS / PICKLEBALL

- Sized right for 10 & Under Tennis and Pickleball
- Constructed of 3" round tubular steel
- Powder coated finish - 36" above ground height
- Complete with brass winder and lacing bars
- Ground sleeves and net sold separately



1371705	Green Post	\$309 ⁹⁹ PR ★
1393373	Black Post	\$309 ⁹⁹ PR ★
1234473	Optional Ground Sleeve - 3" Post	\$69 ⁹⁹ PR ★



Official net and post of the International Tennis Hall of Fame Newport, RI



Throughout their 130 year history, Edwards Sports Products have been associated w/tennis at the highest level, supplying Grand Slam tournaments around the world including Wimbledon & US Open. The famous 40LS net features double netting on the top six rows and a specially designed polyester headband which maximizes durability and minimizes distortion. The 30LS, 30LSDC and 40LS feature extra heavy duty 3.5mm braided polyethylene twine. These tennis nets have a quad stitched white top band & a plastic coated steel cable. The 30LS, 30LSDC & 40LS use only the finest quality materials.

Standard net posts are spaced 42' apart. 42' nets measure 41'6" to fit between these posts. For 40' post spacing, use the 40' net which measures 39'6".



OUTBACK DOUBLE CENTER

- 3.0mm high density braided polyethylene net body
- Heavy duty 18oz vinyl coated headband
- 5 rows of double center mesh
- 5/8" diameter fiberglass dowels
- Center strap and tapered center

5 Year Limited Warranty

1234398 42'L \$229⁹⁹ EA ★



30LS

- 3.5mm high density braided polyethylene net body
- Heavy duty 18 oz. vinyl coated headband
- 5/8" diameter fiberglass dowels
- Center strap and tapered center
- Edwards most popular net, and the one used at Wimbledon

3 Year Limited Warranty

1162479 42'L \$219⁹⁹ EA ★



40LS DOUBLE CENTER

- 3.5mm high density braided polyethylene net body
- Heavy duty 155mm polyester headband
- 5 rows of double center mesh
- 5/8" diameter fiberglass dowels
- Center strap and tapered center

5 Year Limited Warranty

1162462 42'L \$259⁹⁹ EA ★



30LS DOUBLE CENTER

- 3.5mm high density braided polyethylene net body
- Heavy duty 18 oz. vinyl coated headband
- 5 rows of double center mesh
- 5/8" diameter fiberglass dowels
- Center strap and tapered center

5 Year Limited Warranty

1234367 42'L \$239⁹⁹ EA ★



10 & UNDER TENNIS / PICKLEBALL

- 3.5mm braided, knotless nylon netting with 1-3/4" square mesh
- Heavy duty vinyl coated headband
- 5/8" diameter fiberglass dowels
- 42"H x 22"L used for 10 & Under Tennis
- 36"H x 22"L used for 8 & Under Tennis and Pickleball

1296785 10 & Under-42"H x 33"L \$179⁹⁹ EA ★
1296778 8 & Under-Pickleball 36"H x 22"L \$179⁹⁹ EA ★



AUSSIE

- 3.0mm high density braided polyethylene net body
- Heavy duty 18 oz. vinyl coated headband
- 7/8" diameter fiberglass dowels
- Center strap and tapered center

3 Year Limited Warranty

1234374 42'L \$179⁹⁹ EA ★



Varsity 300

- 2.5mm high density braided polyethylene net body
- Heavy duty 18 oz. vinyl coated headband
- 4 rows of lock stitching in headband
- 5/8" diameter fiberglass dowel
- Center strap not included

TN300V42Y 42'L \$129⁹⁹ EA ★



SUPER PRO 5000

- 3.6mm high density braided polyethylene net body
- Heavy duty 18 oz. vinyl coated headband
- 5/8" diameter fiberglass dowels
- Center strap not included

3 Year Limited Warranty
Length: 38', 40', 42'

1296785 10 & Under-42"H x 33"L \$179⁹⁹ EA ★
1296778 8 & Under-Pickleball 36"H x 22"L \$179⁹⁹ EA ★

RolDri THE ORIGINAL WATER REMOVER



MASTER SPONGE ROLLER

- 36" wide roller is made of tough durable polyvinyl alcohol (PVA) foam
- Designed to push water off your court surface
- Anodized aluminum handle with stainless steel, black powder coated T-socket
- Stainless steel, powder coated frame includes all stainless steel hardware
- Replacement rollers include end caps

MTRDMSTR	Complete Unit	\$76 ⁹⁹ EA ★
MTRRTBLU	Master Replacement Roller	\$37 ⁹⁹ EA ★



STAINLESS STEEL T-SOCKET

ROL-DRI SEAMLESS SPONGE ROLLER

ROL-DRI MASTER SPONGE ROLLER

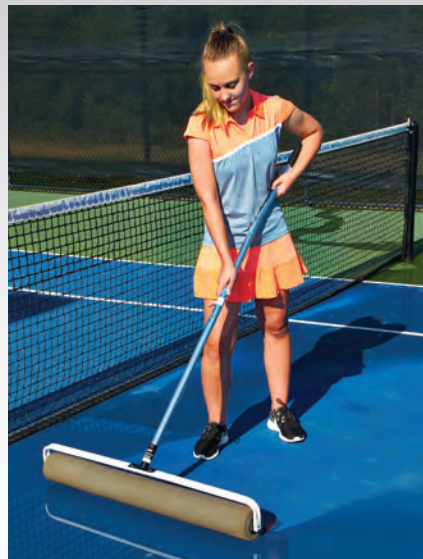

SEAMLESS SPONGE ROLLER

- Gray seamless sponge roller is made of soft absorbent polyurethane (PU) foam - 36" Wide
- Designed to absorb and push water from your court surface
- Anodized aluminum handle with stainless steel, black powder coated T-socket
- Stainless steel powder coated frame includes all stainless steel hardware
- Can also be used on damp grass to improve field conditions
- Replacement rollers include end caps

MTRDSMLS	Complete Unit	\$62 ⁹⁹ EA ★
MTRRSL36M2	Seamless Replacement Roller	\$28 ⁹⁹ EA ★

REPLACEMENT PARTS/ACCESSORIES

- Set includes: handle, hard poly grip, stainless steel T-bracket, hanging clip, and screws
- All hardware is stainless steel

MTHDLASM	Handle Assembly Set	\$27 ⁹⁹ EA ★
-----------------	---------------------	-------------------------



1" BALL PARK HOSES AND KITS

- 1" I.D. heavy-duty clear hose is used by top level facilities throughout the country
- Handles 150 psi operating pressure and 600 lb. burst pressure
- Hose kit includes: hose, hose key, quick connect, spray nozzle and swivel

MSHOSE50	50' Hose Kit	\$589 ⁹⁹ EA
MSHOSE75	75' Hose Kit	\$599 ⁹⁹ EA
MSHOSE00	100' Hose Kit	\$699 ⁹⁹ EA
200101075	75' Hose Only	\$239 ⁹⁹ EA
200101100	100' Hose Only	\$299 ⁹⁹ EA



JET BLAST WATER BROOM

- Constructed of heavy-duty, lightweight aluminum
- Makes cleaning dirt and debris on all types of surfaces a breeze
- Attach a standard water hose to the handle and you're ready to go
- 32" head is fitted with 8 high-pressure nozzles
- 48" head is fitted with 12 high-pressure nozzles

546032	32"	\$259 ⁹⁹ EA
546048	48"	\$289 ⁹⁹ EA



5' COURTSIDE BENCH

- Heavy duty aluminum bench with back
- 2 3/8" OD galvanized steel legs
- Planks are powder coated and come with safety end caps

BEPG05G	Forest Green	\$359 ⁹⁹ EA ★
BEPG05W	White	\$349 ⁹⁹ EA ★

Bid #ESCNJ 17/18-31

Educational Services Commission of New Jersey

Athletic Equipment & Supplies

FREE-STANDING TENNIS SYSTEM

- Made of 3" powder coated square steel with stainless steel winder
- Includes three joining bars
- Transport wheels on each standard
- Net not included with system (See p. 183 for options)
- Indoor/Outdoor use

1244205 310 lbs. \$899⁹⁹ SET ★ **LS&H**



TRANSPORT WHEELS



STEEL WINDER



REPLACEMENT TENNIS NET CABLE

- Replacement cable for 42' long tennis net
- 5/32" Diameter Galvanized Steel Cable
- White Nylon Coated to 7/32" Diameter
- 2800 lb. break strength

MTSCABLE \$24⁹⁹ EA ★



POLYESTER CENTER STRAP

- All polyester center strap
- Complete with all hardware to attach strap to net

5 Year Limited Warranty

1158267 \$10⁴⁹ EA ★

MacGregor CENTER STRAP

- 100% nylon center strap
- 100% synthetic nylon webbing

MITSTRAP \$8²⁹ EA ★

GROUND ANCHOR

- Heavy duty zinc plated ground anchor

1234466 \$11⁹⁹ EA ★

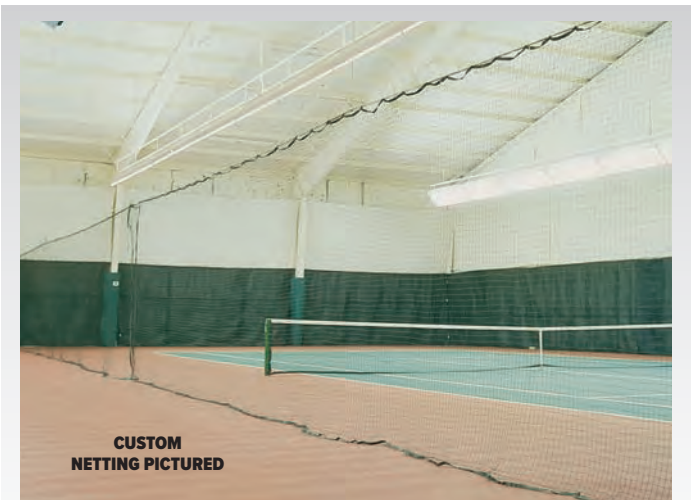

CUSTOM NETTING PICTURED

COURT DIVIDER NETTING

- 2.0mm x 1 3/4" black mesh, EHT braided knotless netting
- 1-1/2" vinyl border double-stitched to top, bottom and sides
- Grommets every 15" along top and sides

TNDIV420 Size: 10'H x 60'L \$299⁹⁹ EA ★

CUSTOM INDOOR DIVIDER NETTING

- 2.0mm x 1 3/4" mesh, EHT braided knotless netting
- All nets include 1.5" vinyl border with grommets every 18" double sewn on top and sides
- Available in green or black
- Minimum order 200 sq. ft.

SNDIVBLK Black - Specify Size \$0⁷⁵ SQ.FT
SNDIVGRN Green - Specify Size \$0⁷⁵ SQ.FT

DIVIDER NETTING OPTIONS

- 18" wide green vinyl bottom plate (added to existing dimensions)

MTVBOTPL \$1⁴⁹ FT

Lead Lining in Border

- Sewn into bottom border for added weight

MTLEADLN Specify Length \$1⁴⁹ FT

1/4" Diameter Steel Cable

- For hanging divider netting

STCABLES Specify length of each piece \$0⁶⁹ FT

Divider Hanging Kit

STDIVKIT \$119⁹⁹ EA

MASTER REPLACEMENT HEADBAND

- Heavy duty vinyl headband with brass grommets every 7"
- Complete with rolled edges and double stitching
- 42"L x 6 1/2"W with 60' of lacing cord

MTSHEADB \$37⁹⁹ EA ★



NET REPAIR/LACING CORDS

- Black poly twine

1236743 \$39⁹⁹ SPOOL ★

MTTWINEB 500' Spool - 3 mm



NJ State Approved Co-op #65MCESCPS Metuchen/Garden State Apparatus Bid Term: 5/9/18 - 5/8/20 Extended to 5/8/21



TUFFY® WINDSCREEN

- The toughest, highest quality windscreen in the world
- Made with exclusive Vipol® Matrix 10 oz. material, a super-durable mesh fabric of tightly woven micro fibers
- Offers more sun UV resistance, is virtually tear proof, and has the highest puncture and tear resistance
- Allows 22% wind pass-through - 78% shade factor
- Tuffy is the only windscreen featuring LOCK-STITCH finishing to assure that it's sides and corners do not unravel
- Fully sun UV and mildew inhibitor protected
- Grommeted every 12" on all 4 sides
- 9' model complete with half moon vents and a grommet strip line

5 Year Limited Warranty

1232566	5' High	\$0 ⁹³ SQ.FT
1285598	6' High	\$0 ⁹⁵ SQ.FT
1285604	9' High	\$0 ⁹⁹ SQ.FT
1298253	Boxed Air Vent	\$9 ⁹⁹ EA



CHROMA-BOND® IMPRINTING

- Double coated multicolor imprinting that does not fade, flake or scuff like other spray on or digital imprinting
- Images are sharp, vivid and outlast any other type of imprinting
- School colors can be matched

2 Color Logo & Lettering on a 3rd Color Background

1297782	Overall Size up to 4'H x 50'L	\$1,899 ⁹⁹ EA
1297799	Overall Size up to 3'H x 30'L	\$1,599 ⁹⁹ EA

1, 2 or 3 Color Print

1380610	1 Color up to 25 sq. ft.	\$599 ⁹⁹ EA
1380611	1 Color 26-50 sq. ft.	\$749 ⁹⁹ EA
1380613	2 Color up to 25 sq. ft.	\$699 ⁹⁹ EA
1380614	2 Color 26-50 sq. ft.	\$849 ⁹⁹ EA
1380616	3 Color up to 25 sq. ft.	\$799 ⁹⁹ EA
1380617	3 Color 26-51 sq. ft.	\$949 ⁹⁹ EA

1 or 2 Color Letters only

1298154	Up to 24" T	\$57 ⁹⁹ EA
1298161	Up to 36" Tall	\$64 ⁹⁹ EA
1298178	Up to 48" Tall	\$79 ⁹⁹ EA
1298185	Up to 60" Tall	\$93 ⁹⁹ EA
1298192	Up to 72" Tall	\$114 ⁹⁹ EA
1298208	Up to 84" Tall	\$124 ⁹⁹ EA



POLYPLUS WINDSCREEN (OPEN MESH)

- Perfect for high wind areas - allowing 25% wind pass through
- Constructed of open mesh Leno Polypropylene with special reinforcing threads to resist tearing
- Grommets on all 4 sides at 12" intervals
- 100% mildew proof
- 9' style includes center tie down but not air vents

MT6LPXXX	6'H - Dark Green	\$0.83 SQ.FT
MT6LPBLX	6'H - Royal Blue	\$0.83 SQ.FT
MT6LPBKX	6'H - Black	\$0.83 SQ.FT
MT9LPCXX	9'H - Dark Green or Black	\$0.89 SQ.FT

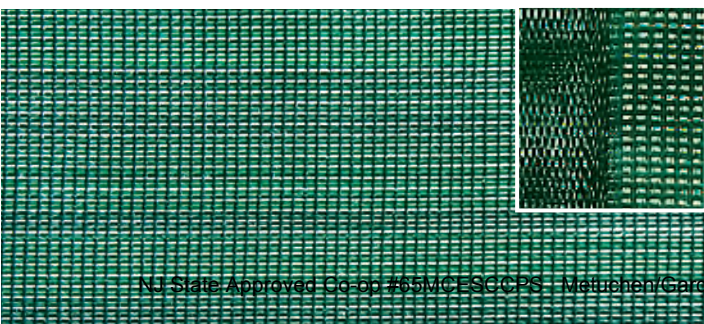

POLYPROPYLENE WINDSCREEN (CLOSED MESH)

- Mildew and insect resistant and contains a built in UV inhibitor to withstand exposure to sun, wind and rain.
- 95% shade factor
- Includes grommets on all 4 sides spaced every 12"
- Center tie downs are included but not air vents (recommended)

MT6PPCMX	6' High - Dark Green only	\$0.89 SQ.FT
MT9PPCMX	9' High - Dark Green only	\$0.94 SQ.FT
MTCTDOWN	Center Tie Down	\$0.59 FT
1298253		\$9 ⁹⁹ EA



QUALITY • DURABILITY • CRAFTSMANSHIP

RACQUET SPORTS



BSN SPORTS' POLYESTER WINDSCREEN

- 8oz. weight/sq. yard construction, 84% shade factor, maximum UV protection
- Custom cut to any size
- Brass tooth grommets spaced every 18" on all four sides
- IncrediSeal - eliminates all sewing and stitching
- 9' comes standard with lacing lip and half moon vents
- Match school logos exactly-digitally printed directly from your image file
- State of the art digital printing with unlimited color options

Without Printing

1393784	up to 5'H	\$0.77	SQ.FT
1393785	6'H	\$0.78	SQ.FT
1393786	9'H	\$0.80	SQ.FT

With Printing

1398129	up to 5'H	\$5.99	SQ.FT
1398130	6'H	\$5.99	SQ.FT
1398131	9'H	\$5.99	SQ.FT

FOREST GREEN	ROYAL BLUE	BLACK
NAVY	ORANGE	MAROON
RED	CAROLINA BLUE	KELLY GREEN
BROWN	TAN	PURPLE
WHITE	GRAY	YELLOW



ARMORMESH WINDSCREEN

- Features 14 oz. woven, extrusionvinyl-coated polyester
- Excellent tear strength and outstanding abrasion resistance
- Fabricated with IncrediSeal technology
- 75% shade factor
- Lacing lip and half moon vents standard on screens over 6'
- Match school logos exactly-digitally printed directly from your image file
- State of the art digital printing with unlimited color options

Without Printing

1393787	up to 5'H	\$0.85	SQ.FT
1393788	6'H	\$0.86	SQ.FT
1393789	9'H	\$0.88	SQ.FT

With Printing

1398132	up to 5'H	\$6.49	SQ.FT
1398133	6'H	\$6.49	SQ.FT
1398134	9'H	\$6.49	SQ.FT

DARK GREEN	ROYAL BLUE	RED
KELLY GREEN	MAROON	NAVY
BLACK	PURPLE	ORANGE
GRAY	CAROLINA BLUE	YELLOW
WHITE		



TIDI-COOLER STAND SET

- Includes: stand, trash can, 5 gallon Igloo® cooler, and cup dispenser

1263244	Black Stand with Green Cooler	\$244⁹⁹ SET ★
1263251	Black Stand with Yellow Cooler	\$244⁹⁹ SET ★
1255669	Green Stand with Green Cooler	\$244⁹⁹ SET ★
1255676	Green Stand with Yellow Cooler	\$244⁹⁹ SET ★

TIDI-COOLER STAND

- 100% lightweight, rust free aluminum with powder coated finish
- Wide stance base for more stability
- Includes Tidi-Court basket and security cable with keyed lock to keep lid and cooler secure to stand
- Designed for 5 gallon coolers
- Cooler sold separately

1255652	Green Stand & Basket	\$162⁹⁹ EA ★
1263268	Black Stand & Basket	\$162⁹⁹ EA ★



TIDI-COURT

- Empty your pockets, store your drink cups and cans and keep trash where it belongs with the Tidi-Court
- Uses a simple hose clamp attachment to fit any shape or size post

TNVALET	Green	\$47⁹⁹ EA ★
TNVALETB	Black	\$47⁹⁹ EA ★

Replacement Basket

- Handy replacement basket keeps trash where it belongs...off your court

TNKRBSK	Green	\$26⁹⁹ EA
TNKRBSKB	Black	\$26⁹⁹ EA

Replacement Tray

- Convenient valet tray for storing valuables during play

TNKPRTY	Green	\$26⁹⁹ EA
TNKPRTYB	Black	\$26⁹⁹ EA

Replacement Clamp

- Hose clamp attachment to fit any shape or size post

TNKPRLCP		\$4⁹⁹ EA
-----------------	--	----------------------------



WATER COOLER

- Rugged, durable 400 series industrial strength water coolers with Ultratherm™ insulation keeps water ice cold
- UV Protection prevents surface from chipping, peeling, or rusting
- FDA approved white inner liner is easy to clean and resists stains
- Lid cord attached to prevent loss
- Optional cup dispenser holds approximately 200 (4 or 4.5 oz.) cups-not included



MSIGLO5X	Yellow - 5 Gal.	\$69⁹⁹ EA
MSIGLO10	Yellow - 10 Gal.	\$99⁹⁹ EA
1263220	Green - 5 Gal.	\$69⁹⁹ EA
1263237	Green - 10 Gal.	\$105⁹⁹ EA
1376916	Orange - 5 Gal. Seat Top	\$69⁹⁹ EA
1384468	Orange - 10 Gal. Seat Top w/Cup Dispenser	\$99⁹⁹ EA
MSCUPDIS	Optional Cup Dispenser	\$31⁹⁹ EA
1384470	4.25 oz. Cone Cup - 5000/Case	\$223⁹⁹ EA

TENNIS SCORE TUBE™

- Use tennis balls to keep score
- PVC tube with holes to indicate set score
- A stainless steel hose clamp is supplied to secure to post or net
- Hooks are supplied for fence mounting

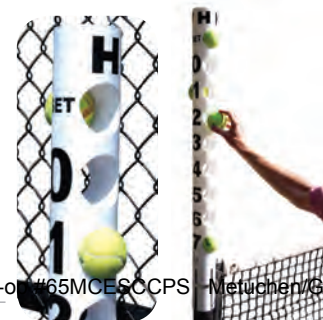

Color Options: Black, White, Approved Co-op #65MCE/SCCPs Metuchen/Garden State Apparel Bid Term: 5/9/18 - 5/8/20: Extended to 5/8/21
 1296099 Specify Color **\$35⁹⁹** EA

SCOREKEEPER

- Chrome steel unit with swivel base
- Game numbers are 4" x 7" plastic
- Includes 2 sets of game numbers (0 to 9), 2 sets of "sets won" (0 to 5), name plate and pen
- Hose clamp attachment



MTKEEPER		\$46⁹⁹ EA ★
MTSKNUMB	Replacement Numbers	\$29⁹⁹ SET ★

QUICKSCORE

- Portable scorecard that sits on top of the net.
- Includes both game & set scores.
- Contains game numbers up to 7 to allow scoring for regular as well as pro sets



1274219 Set of 4 **\$174⁹⁹** SET

Bid #ESC NJ 17/18-31

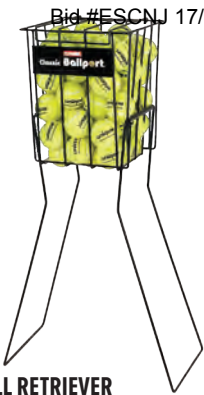

70 BALL RETRIEVER

- Heavy duty wire construction
- Handles flip over to create stand for ball dispensing
- 32"H - 6 lbs.

MTINSTRU **\$41⁹⁹** EA

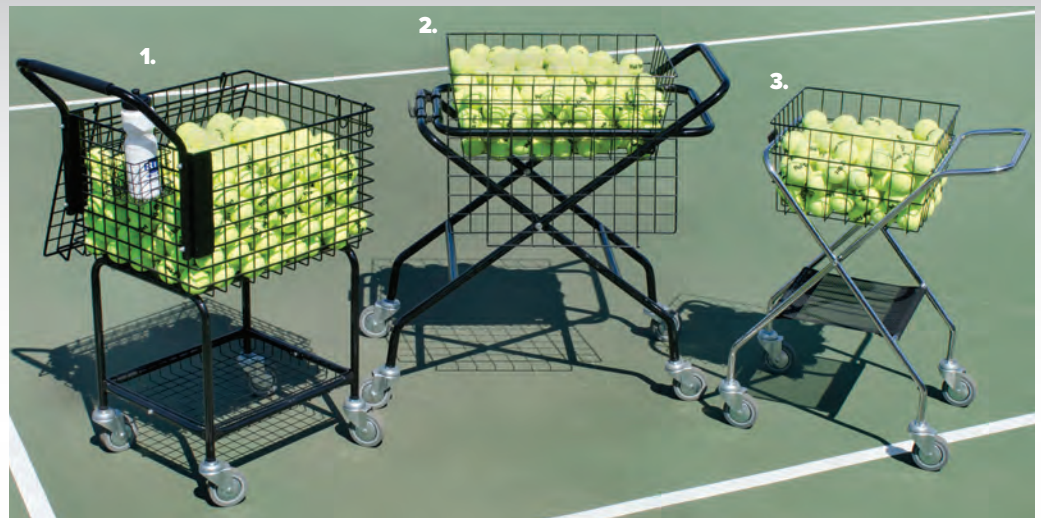

1. DELUXE TEACHING CART

- Powder coated steel frame, vinyl coated basket with foam grip
- Rubber 4" wheels with sealed ball bearings
- Locking lid that lays flat against the side
- Includes basket hanger and convenient water bottle holder
- Holds 325 tennis balls
- Basket Height - 42 1/2"H
- Top Basket - 19" W x 23"L

1342550 **\$259⁹⁹** EA ★

2. FOLDABLE TEACHING CART

- Powder coated steel frame, vinyl coated basket with foam grip
- Folds easily for storage and transportation
- 4" rubber wheels with sealed ball bearings
- Lockable lid
- Includes basket hanger
- Holds 250 tennis balls
- Basket Height - 38"H
- Basket size - 20"W x 30"L

1342543 **\$219⁹⁹** EA ★

3. MINI TEACHING CART

- Chrome steel construction with removable basket
- Folds easily for storage and transportation
- 4" smooth rolling rubber wheels
- Includes mesh bottom storage tray and convenient basket hanger on front of cart
- Hold 150 tennis balls
- Basket height - 34"H
- Basket size - 18"W x 25"L

1369476 **\$149⁹⁹** EA ★

85 BALL RETRIEVER

- Heavy duty wire construction
- 32"H - 5 lbs.

MTRETRIE **\$41⁹⁹** EA



TENNIS CUBE MACHINE



- Compact tennis machine for beginning/intermediate players
- Ball speed and elevation adjustments
- Adjustable ball feed intervals from 2 to 10 seconds
- 10 second delay after turning on machine
- 70 ball capacity
- Includes smart battery charger
- Oscillator model throws balls from side to side in a sweeping motion

3 Year Limited Warranty

1395047 Battery Power Only - With Oscillator **\$739⁹⁹** EA
 1395046 Battery Power Only - No Oscillator **\$659⁹⁹** EA



TENNIS TUTOR PROLITE WITH OSCILLATOR



- Quick set up - Just load the balls and you're ready for action
- Variable ball speed from a gentle toss to hard-hitting ground strokes
- Variable ball feed from one ball every 1-1/2 seconds to one ball every 10 seconds
- Ball trajectory is manually adjustable from ground stroke to lob
- Initial 10 second start up delay
- Use the Oscillator to return shots delivered randomly across the court
- Available battery-powered models typically deliver two to three hours of playing time
- Built-in battery charge indicator and comes with smart battery charger that fully charges the battery overnight

3 Year Limited Warranty

1395048 Electric Powered **\$849⁹⁹** EA
 1395049 Battery Powered **\$629⁹⁹** EA



TENNIS TUTOR PLUS



- Ball Speed up to 85 MPH
- Adjustable ball feed from every 1-1/2 seconds to every 10 seconds
- Ball trajectory is electronically adjustable from groundstroke to lob Full-Court
- Oscillator delivers shots randomly across the court
- 150 ball capacity
- Rechargeable Battery provides up to six hours of playing time per charge
- Low Battery Charge Indicator with Smart Battery Charger
- Start-up time delay allows the player time to get in position
- Fold-out Towing Handle - tows like luggage on built-in caster wheels
- Control the amount of topspin or underspin with a single dial
- Adjustable elevation setting

3 Year Limited Warranty

1395050 Battery Powered Only w/o Remote **\$1,439⁹⁹** EA
 1395051 Battery Powered Only with Remote **\$1,659⁹⁹** EA
 1395052 AC/DC w/o Remote **\$1,659⁹⁹** EA
 1395053 AC/DC with Remote **\$1,859⁹⁹** EA

PROTECTIVE COVER

- Heavy vinyl cover to protect your machine from the elements
- For Tennis Tutor ProLite and Tennis Tutor Plus

3 Year Limited Warranty
 1395054 **\$44⁹⁹** EA



SANDFILLED COLOR CONCENTRATE

- 100% acrylic binder and color pigment for final color coats over properly prepared asphalt and concrete pavements
- Supplied in concentrated form-all you add is water
- A 5 gallon pail produces 7 gallons of paint with the addition of 2 gallons of water
- A typical court requires 100 gallons of SandFilled Color for the recommended two coat application
- Dries in one hour and is ready for play in 24 hours
- Please specify color from chart below

1239089 5 Gallon Pail-Weights 48 lbs.
1239096 55 Gallon Drum-Weights 556 lbs.

\$229⁹⁹ EA **S&H**
\$1,899⁹⁹ EA **S&H**

APPLICATION SQUEEGEE

- 36"W solvent-resistant "clamp style" aluminum frame
- Reversible neoprene blade - long lasting
- 66"L x 1 1/8"D powder-coated aluminum handle with 6" non-slip vinyl grip
- Wrap around bracing

1239072 \$89⁹⁹ EA



CRACK REPAIR

- A colored acrylic latex, fortified with mineral fillers, fibers and silica sand
- Designed to be used as a trowel grade repair for larger cracks
- Comes ready to use
- Dries in 2 hours and is ready for play in 24 hours
- Available colors: Red, Turquoise, Light Green, Blue, Dark Green, Gray, Tan and Maroon

1239041 1 Gallon-Weights 16 lbs \$76⁹⁹ EA
1239058 5 Gallon-Weights 80 lbs \$369⁹⁹ EA



ADVANTAGE CRACK FLEX

- A highly flexible, pourable and colored acrylic latex designed for use in small cracks
- Superior adhesion and resiliency provide longer lasting results
- Comes ready to use in squeezable one gallon jugs
- Dries in 2 hours and is ready to play in 24 hours
- Available colors: Dark Green, Light Green, Red, Black and Neutral

1239034 Specify color \$99⁹⁹ EA



LINE PAINT

- A highly reflective white acrylic paint with texture.
- Designed for use on acrylic coated surfaces or asphalt pavements
- Comes ready to use. Available in white only
- Figure one gallon per tennis court or 450 linear feet per gallon
- Apply by brush, roller or spray
- Dries in one hour and is ready for play in 24 hours

1239065 1 Gallon - 12 lbs. \$84⁹⁹ EA

ADVANTAGE COLORS



SPECIAL FREIGHT APPLIES
QTY 1-3 PAILS: \$25 PER PAIL
QTY 4+ AND DRUM ORDERS:
CALL FOR FREIGHT QUOTE

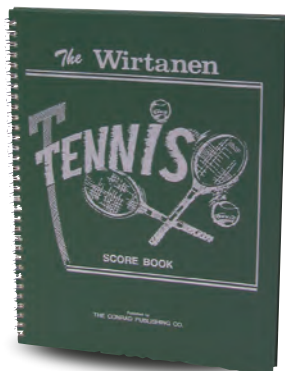

WIRTANEN TENNIS SCOREBOOK

- Includes: 32 matches, summary sheets, tournament charts, individual player record cards

1303254 \$20⁹⁹ EA ★



QUICK-MARK BOUNDARY MARKERS

- Create boundaries quickly and easily
 - Poly-vinyl, non-skid markers
 - Includes (20) 12 1/2"L x 2"W lines and (4) 12" corners
- Lifetime Warranty**

45085 \$65⁹⁹ SET OF 24 ★



ROLL OUT LINE

- Use in place of floor tape
- Vinyl roll will lay flat on a gym floor, outside on the playground or anywhere you need a temporary boundary/ court line

1292138 \$49⁹⁹ EA ★

Bid #ESCNJ 17/18-31

Educational Services Commission of New Jersey

Athletic Equipment & Supplies

RACQUET SPORTS



RUNNETS

PORTABLE NET SYSTEM

- Portable net system for a variety of games and activities
- Ideal for beginning tennis, badminton & volleyball
- Height adjustable from 32" to 52"
- Comes complete with carrying case

1282450	10'L Model	\$114.99 EA ★
1282467	18'L Model	\$134.99 EA ★



QUICKSTART MINI AND MAXI NET SYSTEMS

- Portable net systems for a variety of activities and lead-up games, including tennis, badminton and beginner volleyball
- Nets are easy to set up and take down in 2 minutes or less without tools
- Constructed of durable oval metal tubing
- Mini Net adjusts from 30" - 52" high
- Maxi Net adjusts from 30" to 64" high
- Comes complete with carrying case
- Not intended to be left outside for extended periods of time



20025187	Mini Net - 10'L	\$139.99 EA
20021837	Maxi Net - 18'L	\$159.99 EA

Mini Net Mini Net with extensions



PICKLENET DELUXE

- Official net height and width (34"H x 22"W)
- Can be used on any flat surface and easily moved
- Powder-coated steel system with 4" locking wheels
- Center-strap design for consistent height
- Adjustment straps on net edge for optimal net tension
- Fast and easy assembly; includes carry bag

1390090	49 lbs	\$319.99 EA
----------------	--------	-------------

PICKLEBALL NET

- Official pickleball height (34") and width (22") net
- Portable, powder-coated steel frame net system
- Center-strap design for consistent height
- Adjustment straps on net edge for excellent net tension
- Fast and easy assembly, with nylon storage bag



1363633		\$179.99 EA
----------------	--	-------------

QUICKSTART ROLL-A-NET

- Adjusts from tennis height up to badminton height
- Weather-resistant polyester paint to help avoid rusting with outdoor use
- Easily wheels on and off the court with locking wheels
- Center support wheel with adjustable net tension
- Net rolls up easily and stores in nylon bag with wheels

1377091		\$299.99 EA
----------------	--	-------------



RACQUET CART

- Galvanized steel construction
- Holds up to 64 tennis rackets or 100 table tennis paddles
- Non-marring casters for easy transport



RACQUET CART

- Stores and transports up to 100 racquets and paddles of all types
- Transport all your badminton or tennis equipment in one trip
- Features a basket for storing tennis balls, shuttlecocks and other accessories



1690XXXX

NJ State Approved Co-op #65MCECCPS Metuchen/Garden State Appar Bid Term: 5/9/18 to 5/8/20: Extended to 5/8/21



Wilson
CHAMPIONSHIP TENNIS BALLS

• Can of 3 balls - 24 Cans/Case

MTWILCAN \$4.99 CAN



Penn
CHAMPIONSHIP TENNIS BALLS

• Can of 3 balls - 24 Cans/Case

MTPENCAN \$4.99 CAN

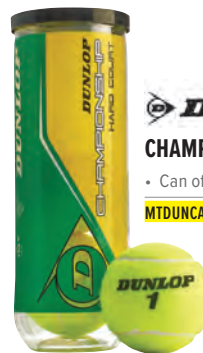

DUNLOP
CHAMPIONSHIP TENNIS BALLS

• Can of 3 balls - 24 Cans/Case

MTDUNCAN \$4.99 CAN



Wilson
TEAM PRACTICE TENNIS BALLS

• Can of 3 balls - 24 Cans/Case

MTWILBAL \$3.99 EA



Penn
PRACTICE/COACH TENNIS BALLS

• Can of 3 balls - 24 Cans/Case

MTPENBAL \$3.99 CAN



RolDri
PRESSURELESS TENNIS BALLS

• Perfect for practice or recreational tennis

1704XXXX \$11.99 DZN ★

WHAT IS 10 & UNDER TENNIS? (Formerly Quickstart Tennis)

10 & Under Tennis is a program designed to help kids 10 years old and under learn to play the game of tennis. A few changes have been made to encourage learning the game....The court sizes. The racquet sizes. The ball sizes. The scoring system. Also, the net height. 10 & Under is now part of the USTA Jr. Tennis league and can be a part of every development program. More kids will be able to enjoy this new format and have lots of fun playing with their friends.

AGE	COURT SIZE	RAQUET	BALL	NET HEIGHT	SCORING
8 yrs & under	36' x 18'	up to 23"	foam or very low compression	2' 9"	-Best 2 out of 3 games -Games to 7 points
10 yrs & under	60' x 21' singles 60' x 27' doubles	up to 25"	low compression	3'	-Best 2 out of 3 sets -Games to 7 points -4 Games = Set -3rd Set Tiebreaker to 7 points



QUICKSTART 36' FOAM BALLS

- Softball sized foam tennis ball
- Designed for 36-foot QuickStart Tennis Court
- Designed for durability and consistent bounce
- Available in Dozen or case of 12 Dozen

1376917 Dozen \$46.99 DZN
1376918 Case of 144 \$489.99 SET OF 144



QUICKSTART 60' BALLS

- Same size as normal tennis balls but bounce about 50% the speed of a regular tennis ball
- Specifically designed for 60-foot QuickStart Tennis court
- Comes in case pack of 24 cans (72 balls)

1376945 24 Cans/Case \$119.99 SET OF 72



QUICKSTART 36' BALL

- 20% larger than standard tennis balls
- Specifically designed for 36-foot QuickStart Tennis court
- Increases the success for beginning children
- Comes in a convenient color-coded 24 or 48-ball bucket

1392977 24 Ball Bucket \$64.99 SET
1392978 48 Ball Bucket \$109.99 SET



QUICKSTART 78' BALLS

- Same size as normal tennis balls, but bounce at about 75% the speed of a regular tennis ball
- They are proven to help players of all ages slow down full-court play for maximum improvement
- Comes in case pack of 24 cans (72 balls)

1376946 24 Cans/Case \$119.99 SET OF 72

MacGregor

RACQUET SPORTS

BEST SELLER



RECREATIONAL SERIES

- Graphite & aluminum fused head and shaft
- O-Beam frame design with PU grip
- Mid-size 95 square inch head
- Available in 4 3/8" or 4 1/2" grip size

1393401	27"L - 4 3/8" Grip (Orange/Black)	\$25⁹⁹ EA ★
1393402	27"L - 4 1/2" Grip (Green/Black)	\$25⁹⁹ EA ★



WIDE BODY SERIES

- Graphite & aluminum fused head and shaft
- O-Beam frame design with PU grip
- Over-size 110 square inch head
- Available in 4 1/4", 4 3/8" or 4 1/2" grip size

1393403	27"L - 4 1/4" Grip (Green/White)	\$28⁹⁹ EA ★
1393404	27"L - 4 3/8" Grip (Blue/White)	\$28⁹⁹ EA ★
1393405	27"L - 4 1/2" Grip (Red/White)	\$28⁹⁹ EA ★



YOUTH SERIES

- Graphite & aluminum fused head and shaft
- O-Beam frame design with PU grip
- Mid-size 95 square inch head
- Available in 21", 23" & 25" length

1393406	21"L - 4" Grip (Black/Yellow)	\$23⁹⁹ EA ★
1393407	23"L - 4" Grip (Black/Orange)	\$23⁹⁹ EA ★
1393408	25"L - 4" Grip (Black/Silver)	\$23⁹⁹ EA ★



Wilson ENERGY XL

- V-Matrix™ Technology for larger sweet spot
- 10.3 oz strung weight(291g)
- 4 3/8" grip size

1388070	27.5"L	\$29⁹⁹ EA
----------------	--------	-----------------------------



Wilson TOUR SLAM™

- Volcanic frame technology for power and stability
- 11.5 oz strung weight(326g)
- 4 3/8" grip size

1388071	27.25"L	\$34⁹⁹ EA
----------------	---------	-----------------------------



Wilson FEDERER

- Features Arc Technology for greater stability
- 10.4 oz strung weight(295g)
- 4 3/8" grip size

1388072	27.25"L	\$40⁹⁹ EA
----------------	---------	-----------------------------



TOURNA GRIP® RACQUET GRIPS

- Extremely durable and well cushioned for maximum comfort and performance
- Use with all tennis, badminton, squash and racquetball racquets
- Comes in a package of 3 rolls, 10 racquets per roll for a total of 30 grips

1065190		\$53⁹⁹ PACK OF 30
----------------	--	-------------------------------------



NEW! HEAD SPEED 25 JR.

- 107 square inch head that weighs only 7.4 oz.
- Junior racquet for ages 8 and up
- 3 7/8" synthetic grip

1399705



HEAD TOUR PRO

- Features an oversize durable aluminum alloy head and weighs only 9.7 oz.
- Perfect racquet for the recreational tennis player

1377079

27"L	\$29⁹⁹ EA
------	-----------------------------



HEAD TI RADICAL ELITE

- Features an oversize titanium technology head and weighs only 10.4 oz.
- Fused graphite for extra feel and power
- Extra long length for added reach

1377080

27"L	\$45⁹⁹ EA
------	-----------------------------

PORTABLE BADMINTON GAME STANDARDS

- 2 3/8" OD Flo-coated* galvanized standards
- 24"D steel base with rubber floor protector
- Roll-away wheels, no floor plates necessary
- Includes economy badminton net
- Blue only

STBMNSTD 160 lbs. \$499⁹⁹ PR ★

PROTECTIVE BASE PAD

- Vinyl covered bonded foam
- Easy to install with hook-and-loop attachments
- Blue only

1012385 \$109⁹⁹ EA ★



COMPETITION BADMINTON STANDARDS

- Galvanized steel with gray hammertone powder coated finish
- Stable T-base design
- Rubber floor protectors
- Includes collegiate badminton net

STBMNXXX 175 lbs. \$549⁹⁹ PR ★ **SeH**

Gold Medal BADMINTON NETS

CODE	MODEL	USE	NET	HEADBAND	CABLE	BOTTOM & SIDETAPES	PRICE
MACBMNET	PROFESSIONAL 21' x 2.5'	Competition	Weather treated knotless nylon	White HD vinyl	14" poly rope	Vinyl coated nylon	\$43 ⁹⁹ EA ★
SNBMNCOL	COLLEGIATE 21' x 2.5'	Intramurals	34" mesh nylon	Vinyl coated nylon	Braided nylon - 4mm	Double stitched nylon	\$30 ⁹⁹ EA ★
SNBMN128	ECONOMY 21' x 2.5'	Recreational	Knotted poly-fiber 3/4" mesh	PVC Vinyl 3mm braided nylon	Braided nylon - 3mm	Single stitched vinyl	\$20 ⁹⁹ EA ★



Carlton SHUTTLECOCKS

- Designed for slow speed/high altitude, medium speed/normal or fast speed/warm conditions
- Sold in tubes of 6
- Weight: 5 grams each

T800WHGR Slow/High Altitude \$14⁹⁹ TUBE
T800WHBL Medium/Normal \$14⁹⁹ TUBE
T800WHRD \$14⁹⁹ TUBE
T900WHBL F2 - Medium/Normal \$17⁹⁹ TUBE



MacGregor TOURNAMENT SHUTTLECOCKS

- Medium speed with nylon feathers and cork tip
- Sold in tubes of 6

1. **MSBIRDNY** White \$10⁹⁹ SET OF 6 ★
 2. **MSBIRDYL** Yellow \$10⁹⁹ SET OF 6 ★
ECONOMY SHUTTLECOCKS
 • White, plastic feathers with rubber tip
MSBIRDPL \$17⁹⁹ SET OF 6 ★
MSBIRDGP \$49⁹⁹ SET OF 144 ★



GAME CRAFT BADMINTON SET

- Includes: 4 nylon strung tempered steel racquets, 1"D steel poles, 2 ground sleeves, 2 shuttlecocks, 2 1/2'H x 20'L net

1651XXXXY \$30⁹⁹ SET ★

MacGregor

RACQUET SPORTS



CHAMP

- Graphite and aluminum fused head and shaft
- Nylon close string with PU grip
- Strung weight: 93 grams
- Length: 26"

1393409 \$19.99 EA ★



TOURNAMENT 110

- Graphite and aluminum fused head and shaft
- Nylon close string with PU grip
- Strung weight: 110 grams
- Length: 26"

1393410 \$15.99 EA ★



TWIN 200

- Graphite and aluminum fused head and twin shaft
- Nylon close string with PU grip
- Strung weight: 110 grams
- Length: 26"

1393411 \$15.99 EA ★



ECONOMY YOUTH

- Graphite and aluminum fused head and shaft
- Nylon close string with PU grip
- Strung weight: 130 grams
- Length: 25"

1393412 \$12.99 EA ★



Wilson MATCHPOINT

- Two piece aluminum frame and flared inside grommets for maximum durability
- Oversized 53 square inch sweet spot
- Strung weight: 120 grams
- Length: 26"

1310122 \$16.99 EA



ONE-PIECE BADMINTON RACQUET

- One-piece molded racquet
- Lightweight flexible design
- Weight: 130 grams

MSRAOZYI \$12.99 EA

carlton



MAXI BLADE 4.3

- Titanium alloy head with steel shaft
- Ideal racquet for recreational play
- Strung weight: 105 grams

20026541 \$22.99 EA



AEROBLADE 3000

- Isometric Titanium Alloy head
- Tempered Steel Shaft for power and durability
- Ideal racquet for recreational play
- Strung weight: 100 grams

1376932 \$18.99 EA



AEROBLADE 2000

- Tempered steel for durability
- Isometric shape head
- Ideal economy recreational racquet
- Strung weight: 120 grams

1376933 \$15.99 EA

NJ State Approved Co-op #65MCECCPS Metuchen/Garden State Apparel Bid Term: 5/9/18 - 5/8/20: Extended to 5/8/21



NEW!

HYPER TI

- Alloy construction
- Weight: 195g
- Head Size: 500 sq. cm
- String Pattern: 14 x 19

1399655 27" L \$27⁹⁹ EA

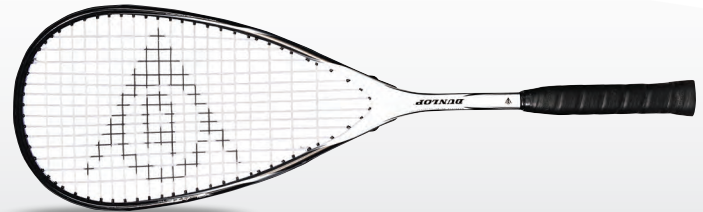

BLAZE PRO

- Graphite Alloy construction
- Weight: 180g
- Head Size: 500 sq. cm
- String Pattern: 14 x 20

1390099 27" L \$36⁹⁹ EA



PRO DOUBLE DOT SQUASH BALL

- Ball is best suited for advanced & serious players.
- The official ball of the WSF (World Squash Federation) and the PSA (Professional Squash Association).
- Low bounce



COMPETITION SQUASH BALL

- Ball provides great performance and great value for club and intermediate play
- Standard size with a 10% longer hang-time to that of the Dunlop Pro Squash Ball.

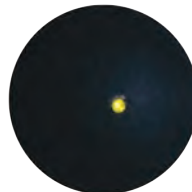

USHA 21⁺ HANDBALL

- Exclusively USHA endorsed
- 1 ball per can

1553XXXX \$10⁹⁹ CAN

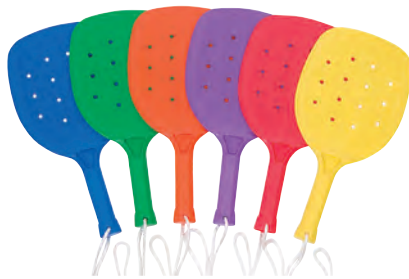

PLASTIC MOLDED PADDLES

- Tough one-piece molded paddles for elementary and junior high players
 - Junior size (elementary) measure 13 5/8" L x 6 1/2" W - weigh 7 oz.
 - Youth size (junior high) measure 16" L x 7 1/2" W - weigh 12 oz.
- Color Options: **Blue, Green, Orange, Purple, Red, Yellow.**

1197778 Junior Size - Specify Color \$10¹⁹ EA ★
1197839 Youth Size - Specify Color \$11¹⁹ EA ★



MacGregor PADDLEBALL RACQUET

- Features 7-ply laminated 9mm wood construction, 50 hole face, double-riveted wooden handle, leather grip and leather wrist strap
- 15 3/4" L x 8" W

MSPBRDLX \$16⁹⁹ EA ★



PICKLE-BALL[®] PADDLE

- Graphite surface with a composite, honeycomb core
- Great paddle with power, touch and durability
- Features a comfortable cushioned grip
- 15 1/2" L x 8 1/8" W with 4 1/4" thick grip
- Weighs 7oz. - 8oz. - Made in the USA

90 Day Limited Warranty
 Color Options: **Blue, Red.**

1384931 Specify Blue or Red \$84⁹⁹ EA



HEAD IMPULSE

- Ultra lightweight design with adjustable strap
- Anti-fog treated with shatterproof polycarbonate lenses

1238983



PROTECTIVE EYEWEAR

- Durable, lightweight plastic with adjustable strap
- One size fits all

1720XXXX \$10⁹⁹ EA ★



DELUXE EYE PROTECTORS

- High impact polycarbonate, scratch resistant lenses
- Durable cushioned nose piece
- Non fogging

1723XXXX



OVERGLASS PROTECTORS

- Durable, lightweight plastic
- Fits right over your own prescription glasses
- Protects eyes, nose and temples while

1721XXXX \$22⁹⁹ EA ★



ULTRA BLUE RACQUETBALL

- The World's #1 Selling Racquetball
- Ultra blue racquetball gives long, lively, and consistent play
- Microscopic texturization for extra bite

1555XXXX Can of 3 \$5.89 CAN



PRO GREEN RACQUETBALL

- The official ball of USA Racquetball makes the Pro Penn the most widely used ball in tournament play.
- Bright green color has a great on-court visibility.
- Consistent speed, playability and durability

1556XXXX Can of 3 \$6.99 CAN



HIGH DEFINITION RACQUETBALL

- Penn's new HD High Definition racquetball.
- Optimum on-court visibility
 - Faster, livelier and consistent playability
 - Lighter weight for a more comfortable feel
 - Increased durability

1557XXXX Can of 3 \$7.49 CAN



12-BALL CANISTER

- The world's #1 selling racquetball
- Ultra blue color offers added visibility
- Ideal for all levels of play

1238976 \$25.99 CAN



SCHOLASTIC

- Powder coated aluminum O-Beam frame
- Tear drop head with built-in bumper
- Open throat design
- Soft 4" PU grip
- Strung weight: 210 grams

1393414 22" L \$21.99 EA ★

COLLEGIATE

- Tear drop head with aluminum O-Beam frame
- Built-in bumper with open throat design
- Soft 4" PU grip
- Strung weight: 210 grams

1393413 22" L \$24.99 EA ★

HEAD

NEW!
MX FIRE

- Metallix alloy provides a stronger, lighter, stiffer and more powerful construction
- PowerZone String Pattern
- Head Size 106.5 sq. in. - Grip Size 3-5/8"
- Weight - 200 grams

1399707 22" L \$29.99 EA



NEW!
MX CYCLONE

- Metallix alloy provides a stronger, lighter, stiffer and more powerful construction
- Pyramid V PowerZone String Pattern
- Head Size 106.5 sq. in. - Grip Size 3-5/8"
- Weight - 190 grams

1399706 22" L \$39.99 EA

E-FORCE

REVOLT

- Thick, reinforced frame
- Extremely Durable
- Platinum 16 gauge string
- 22" LongString™ Technology
- Tri-Tear Head Shape
- 3-15/16" Grip Size



RACQUET SPORTS



POLE VAULT LANDING SYSTEMS

ATHLETICS

All Gill Pole Vault Landing Systems use high density foam which provides long pit life without a hard landing, solid vinyl casings for increased weatherability, and the highest quality hardware.

- G** **MADE IN AMERICA**
- G** **MEET OSHA FALL ARREST STANDARDS**
- G** **18oz VINYL COATED WOVEN POLYESTER**
- G** **PHTHALATES FREE**

ESSENTIALS™ POLE VAULT LANDING SYSTEM

- Meets NFHS requirements
- In place of standard top pad, the Essentials™ employs a skirted mesh top that holds the units together for a snug fit.
- Color: Royal Blue only
- 5 Year Limited Warranty**

GA653	Size: 19'9" x 20'2" x 26"	\$12,999 ⁹⁹ EA	
GA65302	Weather Cover	\$1,599 ⁹⁹ EA	

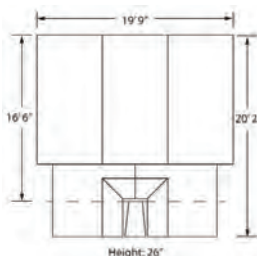

SCHOLASTIC I POLE VAULT LANDING SYSTEM

- Made of 18oz. vinyl-coated polyester fabric
- Meets High School specifications
- Includes 2" top pad

12 Year Limited Warranty

Color Options: **Black, Dk Green, Grey, Navy, Old Gold, Orange, Red, Royal, Yellow Gold, White.**

1375184	Size: 19'9" x 20'2" x 28"	\$15,499 ⁹⁹ EA	
1375194	Weather Cover	\$1,899 ⁹⁹ EA	

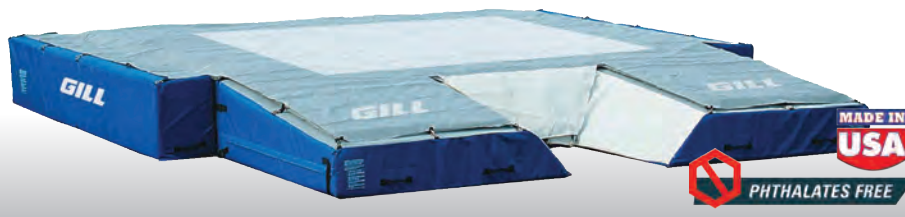
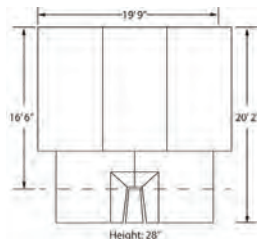

SCHOLASTIC II POLE VAULT LANDING SYSTEM

- Made of 18oz. vinyl-coated polyester fabric
- Meets High School specifications
- Includes 2" top pad

12 Year Limited Warranty

Color Options: **Black, Dk Green, Grey, Navy, Old Gold, Orange, Red, Royal, Yellow Gold, White.**

1375206	Size: 21'6" x 23'5" x 28"	\$18,499 ⁹⁹ EA	
1375216	Weather Cover	\$2,199 ⁹⁹ EA	

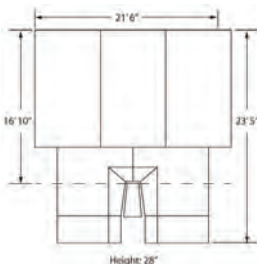

GILL VALUE PACKS
ATHLETICS
ESSENTIALS PACK

GAVP300

INCLUDES:

- Essentials Landing System
- Weather Cover
- Base Pads
- Essentials PV Standards
- Essentials PV Crossbar

\$15,999⁹⁹

SCHOLASTIC I PACK

GAVP305

INCLUDES:

- Scholastic I Landing System
- Weather Cover
- Base Pads
- Scholastic PV Standards
- Essentials PV Crossbar

\$18,999⁹⁹

SCHOLASTIC II PACK

GAVP310

INCLUDES:

- Scholastic II Landing System
- Weather Cover
- Base Pads
- Scholastic PV Standards
- Essentials PV Crossbar

\$20,999⁹⁹



ALL LANDING SYSTEMS REQUIRE SAFETY MAX-VAULT BOX INSERT. SEE PAGE 203

TOP PAD COLORS



VINYL COLORS



COMPETITION, 22'W X 22'L X 28"H (SHOWN WITH BASE PROTECTOR PADS)



COMPETITION POLE VAULT LANDING SYSTEM

- Exceeds all High School specifications
- 22'W x 22'L, Pit has 16' 6"D of landing area behind the vault box
- Includes 2" top pad
- Includes 10'W x 8'D coaches box

OPTIONAL ITEMS

• Base Protector Pads (Required)

Competition Pole Vault Landing Systems

GP2222X32	Size: 22'W x 22'L x 32"H	\$14,799 ⁹⁹	EA ★	
GP2222X28	Size: 22'W x 22'L x 28"H	\$14,299 ⁹⁹	EA ★	
GP2222X26	Size: 22'W x 22'L x 26"H	\$13,799 ⁹⁹	EA ★	

Weather Cover

GWC2222X32	32"	\$1,459 ⁹⁹	EA ★	
GWC2222X28	28"	\$1,389 ⁹⁹	EA ★	
GWC2222X26	26"	\$1,379 ⁹⁹	EA ★	

Base Protector Pads

STPADCTL32	32" W x 130" L	\$2,579 ⁹⁹	PR ★	
STPADCTL28	28" W x 130" L	\$2,499 ⁹⁹	PR ★	
STPADCTL26	26" W x 130" L	\$2,479 ⁹⁹	PR ★	

SCHOLASTIC, 20'W X 21'L X 28"H

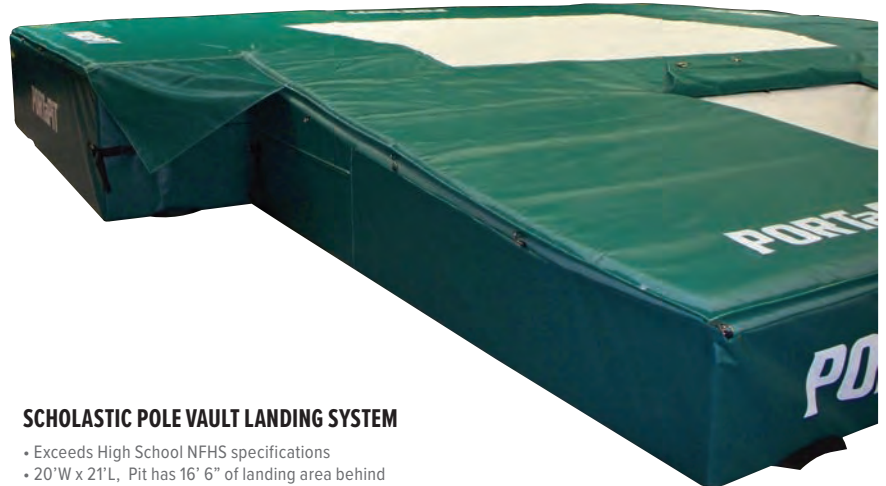

SCHOLASTIC POLE VAULT LANDING SYSTEM

- Exceeds High School NFHS specifications
- 20'W x 21'L, Pit has 16' 6" of landing area behind the vault box
- Includes 2" top pad
- Includes 10'W x 8'D Coaches Box
- Waffle system of deceleration

OPTIONAL ITEMS

• Base Protector Pads (Required)

Scholastic Pole Vault Landing Systems

GP2021X28	Size: 20'W x 21'L x 28"H	\$12,599 ⁹⁹	EA ★	
GP2021X26	Size: 20'W x 21'L x 26"H	\$11,999 ⁹⁹	EA ★	

Weather Cover

GWC2021X28	28"	\$1,299 ⁹⁹	EA ★	
GWC2021X26	26"	\$1,269 ⁹⁹	EA ★	

Base Protector Pads

STPADCTR28	28" W x 107" L	\$1,799 ⁹⁹	PAA ★	
STPADCTR26	26" W x 107" L	\$1,699 ⁹⁹	PR ★	



GRAPHICS FOR LANDING SYSTEMS

- Full color image of your mascot or your school name in the center of your top pad.
- Simply send camera-ready artwork along with your order and we will either mail or e-mail you a copy of the design for your signed approval.
- Please allow two to six weeks for delivery.

20028462 Maximum Size: 8' x 10' \$11⁹⁹ SQ.FT ★



ALL LANDING SYSTEMS REQUIRE SAFETY MAX+ VAULT BOX INSERT. SEE PAGE 203



HIGH JUMP LANDING SYSTEMS

ATHLETICS

All Gill Jump Landing Systems use high density foam which provides long pit life without a hard landing, solid vinyl casings for increased weatherability, and the highest quality hardware.

- G** **MADE IN AMERICA**
- G** **MEET OSHA FALL ARREST STANDARDS**
- G** **18oz VINYL COATED WOVEN POLYESTER**
- G** **PHTHALATES FREE**

ESSENTIALS HIGH JUMP LANDING SYSTEM

- Meets all high school rules requirements.
- In place of standard top pad, the Essentials' employs a skirted mesh top that holds the units together for a snug fit.
- (2) Base units: 8' x 8' x 24"
- Color: Royal blue only

5 Year Limited Warranty

GA640A	Size: 8' x 16' x 24"	\$4,999 ⁹⁹ EA	
GA640A02	Weather Cover	\$799 ⁹⁹ EA	

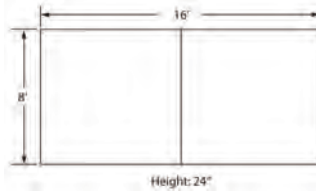

SCHOLASTIC I HIGH JUMP LANDING SYSTEM

- Made of 18oz. vinyl-coated polyester fabric
- Meets High School specifications
- Includes 2" top pad

12 Year Limited Warranty

Color Options: **Black, Dk Green, Grey, Navy, Old Gold, Orange, Red, Royal, Yellow Gold, White.**

1371587	Size: 16'6" x 8' x 26"	\$6,699 ⁹⁹ EA		
1371597	Weather Cover	\$999 ⁹⁹ EA		

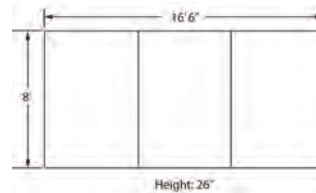

SCHOLASTIC II HIGH JUMP LANDING SYSTEM

- Made of 18oz. vinyl-coated polyester fabric
- Meets High School and NCAA specifications
- Includes 2" top pad

12 Year Limited Warranty

Color Options: **Black, Dk Green, Grey, Maroon, Navy, Old Gold, Orange, Purple, Red, Royal, Yellow Gold, White.**

1371562	Size: 16'6" x 10' x 26"	\$8,199 ⁹⁹ EA		
1371572	Weather Cover	\$1,199 ⁹⁹ EA		

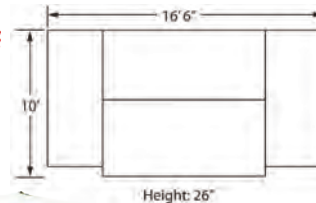

GILL VALUE PACKS
ATHLETICS

Value packs from Gill Athletics are a great way to fully equip your school with quality Gill equipment and save money!

ESSENTIALS PACK

GAVP405

INCLUDES:

- Essentials Landing System
- Weather Cover
- Essentials HJ Standards
- Essentials HJ Crossbar

\$5,999⁹⁹

SCHOLASTIC I PACK

GAVP400

INCLUDES:

- Scholastic I Landing System
- Weather Cover
- Scholastic HJ Standards
- Essentials HJ Crossbar

\$7,999⁹⁹

SCHOLASTIC II PACK

GAVP410

INCLUDES:

- Scholastic II Landing System
- Weather Cover
- Scholastic HJ Standards
- Essentials HJ Crossbar

\$9,799⁹⁹

TOP PAD COLORS



VINYL COLORS



24" and 28" HEIGHT OPTIONS

CODE	OVERALL SIZE	3 BASE UNITS	TOP PAD	WEIGHT
GP1218X28	12' x 18' x 28"	6' x 12' x 26"	12' x 18' x 2"	750-LBS
GP1218X24	12' x 18' x 24"	6' x 12' x 22"	12' x 18' x 2"	680-LBS

COMPETITION HIGH JUMP LANDING SYSTEM

- Made of 18 oz. coated polyester fabric
- Meets all High School and NCAA specifications
- Includes 2" top pad

5 Year Limited Warranty

GP1218X28	Size: 12' x 18' x 28"	\$7,599 ⁹⁹ EA ★
GWC1218H	Weather Cover	\$749 ⁹⁹ EA ★
GP1218X24	Size: 12' x 18' x 24"	\$6,799 ⁹⁹ EA ★
GWC1218M	Weather Cover	\$749 ⁹⁹ EA ★



24" and 28" HEIGHT OPTIONS

SCHOLASTIC HIGH JUMP LANDING SYSTEM

- Made of 18 oz. coated polyester fabric
- Meets all High School and NCAA specifications
- Includes 2" top pad

5 Year Limited Warranty

GP0816X28	Size: 8' x 16'6" x 28"	\$4,999 ⁹⁹ EA ★
GWC0816H	Weather Cover	\$529 ⁹⁹ EA ★
GP0816X24	Size: 8' x 16'6" x 24"	\$4,699 ⁹⁹ EA ★
GWC0816M	Weather Cover	\$529 ⁹⁹ EA ★

PORTaPit LANDING SYSTEMS AVAILABLE IN:

--	--	--	--	--	--	--	--	--	--	--	--

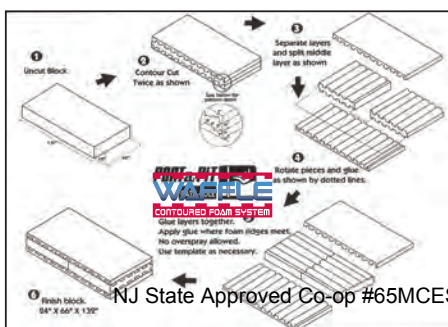

Why PORTaPit[®] is a Better Value

ALL VAULTING PITS & HIGH JUMP PITS FEATURE THE REVOLUTIONARY WAFFLE DESIGN AND INCLUDE A 5-YEAR LIMITED WARRANTY!



HEAVY DUTY WEATHER COVER

-PORTaPit®



COMPETITION

- Steel uprights and 18" base are finished with silver powder coat
- Adjusts from 2'-8' marked with English/Metric scale
- Meets NFHS and NCAA specifications

1378658 \$399⁹⁹ PR ★



ELITE

- Aluminum uppers paired with steel base for exceptional stability
- Low profile base is equipped with wheels for easy transport
- Height adjustments for 2' - 8'6" with English/Metric scale
- Meets NFHS and NCAA specifications

1378710 \$599⁹⁹ PR ★



ESSENTIALS

- All steel construction with black powder coat finish
- 18" square base with wheels
- Height scales read in English and Metric from 2' to 8'
- Meets High School and NCAA specifications

10 Year Limited Warranty
GA700 \$439⁹⁹ SET



COLLEGIATE

- Made of heavy gauge steel which bolts to a 18" square roll away base
- Riser is aircraft aluminum with cast aluminum bar rest
- Adjusts from 2' to 8'
- Meets High School, NCAA® and IAAF specifications

GA705 \$1,069⁹⁹ SET



GILL ATHLETICS WOOD DECK PIT CART

- Constructed of 3/4" MDO exterior plywood
- Cart deck measures 4' x 8'
- 12" pneumatic wheels for easy maneuverability
- Deck height is 16"

GA767 \$1,599⁹⁹ EA



MADE IN USA
PORTaPit® ELEMENTARY HIGH JUMP PIT

- Ideal for elementary physical education classes
 - Created and designed for the younger athlete
 - Meets our own rigorous safety standards
 - This pit does not require a top pad
- 5 Year Limited Warranty**

GBU24511 \$2,399⁹⁹ EA ★
GBU30511 \$2,199⁹⁹ EA ★

NJ State Approved Co-op #65MCE SC GPS Metuchen/Garden State Apparel Ltd Terms 5/9/18 - 5/8/20: Extended to 5/8/21

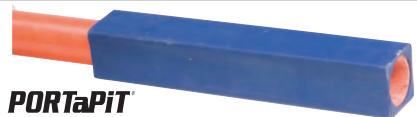

PORTaPit® PREMIER HJ CROSSBAR

- Pole is 13' 1 1/2"
 - Meets collegiate, international, and NFHS specification
- 2 Year Limited Warranty**

AFHJ1500 \$66⁹⁹ EA ★
AFHJ1503 \$176⁹⁹ SET ★

S&H= \$75⁰⁰ PER ORDER (Up to 3 Crossbars)



GILL ATHLETICS 3 PIECE CROSSBAR

- Utilizes durable thick-walled fiberglass material
- Crossbar that ships small parcel as opposed to truck
- Meets NFHS and NCAA specifications

GA532 \$154⁹⁹ EA



ESSENTIALS

- All steel tubing construction
- Height adjustment 6' to 16' reading both English and Metric
- Upright detaches for base rails for storage
- 75mm bar rest pins and 8 base anchors included
- Meets NFHS specifications

GA7100 \$1,349⁹⁹ EA



ALUMINUM

- All aluminum construction for superior resistance
- Wide stance base for improved stability
- Adjusts from 7' to 18'
- Marked for English and metric measurements
- Meets High School and NCAA specifications

GA7130 \$2,149⁹⁹ SET



ELITE

- Aluminum upper paired with steel base for exceptional stability
- Base adjusts 0"-32" on easy glide polyurethane skate wheels
- Detachable uprights adjust from 8'-20' with English/Metric scale
- Equipped with 75mm bar rest pins (55mm pins sold separately)
- Meets NFHS and NCAA specifications

1378720 \$1,299⁹⁹ PR ★



EASILY ATTACHES TO STANDARDS FOR EXTRA 3' LOWER SETTINGS

COMPETITION

- Steel uprights and base are finished with silver powder coat
- Base adjusts 0"-32" on easy glide polyurethane skate wheels
- Detachable upright adjusts from 7'-18' marked with English/Metric scale
- Equipped with 75mm bar rest pins (55mm pins sold separately)
- Meets NFHS and NCAA specifications

1378660 \$999⁹⁹ PR ★
 AFEXTEND Extenders \$99⁹⁹ PR ★
 1378679 55mm Bar Rest Pins (Set of 12) \$19⁹⁹ SET ★

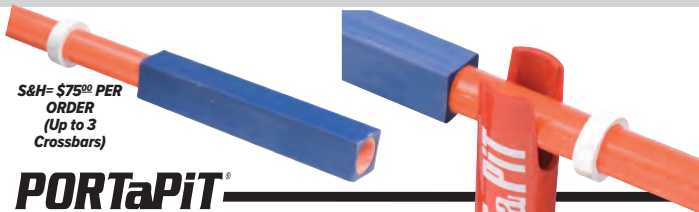

S&H = \$75⁰⁰ PER ORDER (Up to 3 Crossbars)

PORTaPiT[®] PREMIER PV CROSSBAR

- Pole is 14"10"L
- Meets Collegiate, International, and NFHS specifications
- Comes with Nofzinger feature
- 2 Year Limited Warranty

AFPV1500 \$66⁹⁹ EA ★
 AFPV1503 Set of 3 \$176⁹⁹ SET OF 3 ★

GADGET BAR LIFTER

- Ideal bar replacement tool
- Fits all regulation crossbars

1126310 \$27⁹⁹ EA ★

PORTaPiT[®]

POLE VAULT BOX COLLAR SYSTEM

- Cover is made with heavy duty vinyl
- Made of polyethylene foam filler to meet new ASTM F-2942-12 specifications
- Comes with four (4) in ground anchors
- Fits any pole vault landing system

1388862 \$499⁹⁹ EA ★



SEE PAGE 212 FOR VAULT BOX OPTIONS



SAFETY MAX VAULT BOX COLLAR

- Provides additional protection by padding exposed hard surfaces
- Fully compliant with ASTM Standard F2949
- Safety yellow color helps highlight open area for planting and vaulting
- SafetyMax will work with any style of pole vault landing system
- Vault Box is not included with the collar



ELASTIC CROSSBAR

- Elastic practice crossbar with black foam
- Fits both high jump and pole vault

AFR050BM \$29⁹⁹ EA



PORTaPit®

STARTING BLOCKS



COMPETITION

- All steel components
- Spring loaded plunger for pedal adjustment and secure locking
- Complete with spikes for all surface types

ASB2000S

~~\$~~89⁹⁹ EA ★

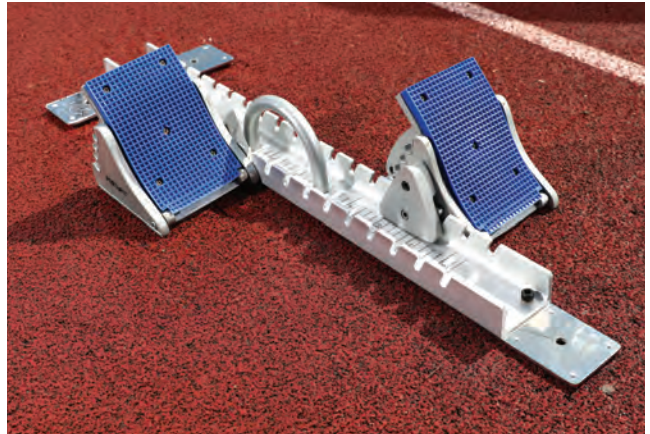

PREMIER

- Cast aluminum, 4-angle wide adjustable pedals
- Durable polished aluminum chrome rail
- Block measures: 12.5"W x 33"L
- Complete with spikes for all surface types

ASB4500X

~~\$~~179⁹⁹ EA ★

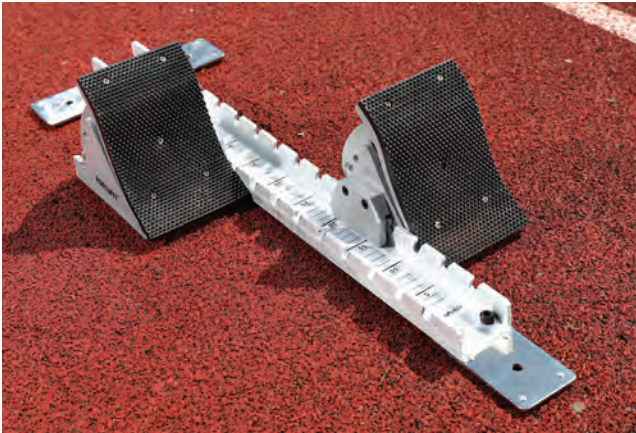

ELITE

- Cast aluminum, 4-angle wide adjustable pedals
- Durable aluminum rail
- Block measures: 12"W x 35"L
- Complete with spikes for all surface types

ASB3500X

~~\$~~159⁹⁹ EA ★

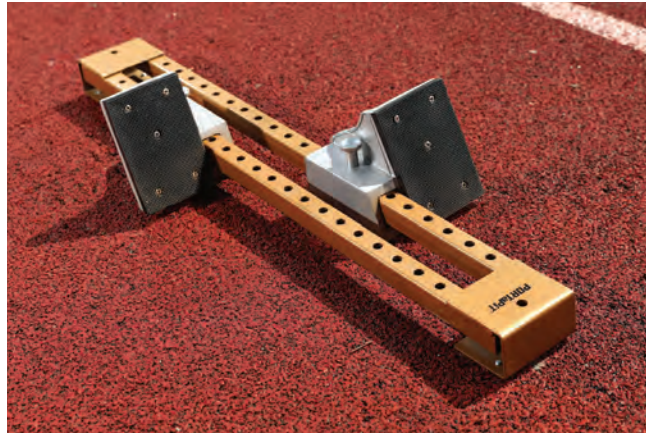

SCHOLASTIC

- Steel double rail with cast pedals and plunger adjustment
- Great for middle and high school programs
- Complete with spikes for all surface types

ASB1500X

~~\$~~79⁹⁹ EA ★



ULTIMATE

- All aluminum construction
- 5-angle adjustable pedals
- IAAF certified and comes with 15mm spikes
- Easy to grab

ASB5000X

~~\$~~199⁹⁹ EA ★

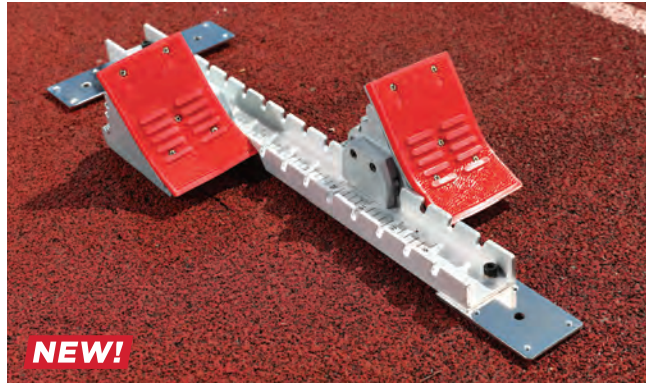

NEW!

ELITE II

- Cast aluminum, 4-angle adjustable pedals
- Durable aluminum rail
- Block measures: 11"W x 30"L

ASB3000

~~\$~~129⁹⁹ EA ★

Bid #ESCNJ 17/18-31

Educational Services Commission of New Jersey

Athletic Equipment & Supplies

TRACK SPIKE KIT

- Spike Kit in a molded container with a 3-way key wrench
- Includes 1,500 spikes: (200) 1/8" pyramid, (400) 1/4" pyramid, (100) 3/8" pyramid, (100) 1/2" pyramid, (400) 1/4" needle, (200) 3/16" needle, (100) 3/8" needle

1273427 \$169.99 EA



PYRAMID SPIKES

BAG OF 100



AASPKP18	1/8"	\$15.99	PACK OF 100
AASPKP14	1/4"	\$15.99	PACK OF 100
1098273	3/16"	\$15.99	PACK OF 100

NEEDLE SPIKES

BAG OF 100



AASPKN18	1/8"	\$15.99	PACK OF 100
AASPKN14	1/4"	\$15.99	PACK OF 100
1098280	3/16"	\$15.99	PACK OF 100

SPIKE WRENCH

SHSPIKWR \$7.99 EA



PORTaPiT[®] INDOOR STARTING BLOCKS

- Non-slip, poly-blocks make it easy to practice indoors during inclement weather
- Simply apply pressure to blocks with foot and blocks provide the athlete with non-slip starts indoors

6036XXXX \$54.99 PR ★



STARTING BLOCK CART

- All steel construction with quality blue enamel finish and easy rolling
- Holds 10 blocks and has storage for spikes and accessories.
- 10" x 2 3/4" wheels

20010511 \$349.99 EA ★

RELAY BATONS

- Lightweight anodized aluminum baton
- Features smooth rolled-in edges and non-slip ground finish
- Official size

Color Options: **Green, Red, Blue, Gold, Silver, Black, Purple.**

AALBAT Aluminum Baton \$3.99 EA ★

APLBATONPK \$2.99 EA ★



HURDLES



ELITE HIGH SCHOOL

- The standard for elite high school track programs
- All aluminum square tube construction with welded cross support
- Meets official high school pullover requirements at 30", 33", 36", 39" and 42"
- Meets high school specifications
- Ships assembled

GA402 Specify Color \$229⁹⁹ EA



HIGH SCHOOL

- Powder coated steel U-shaped single cross support design
- Weighted base and Lexan gateboard
- 41" hurdle adjustable to 30", 33", 36", 39" and 42"
- Meets high school specifications

GA403 Specify Color \$209⁹⁹ EA

TRAINERS



**PORTaPiT[®]
X-TRAINER**

- Ideal hurdle for plyometrics, speed, and agility.
- Adjusts from 6" to 42"
- Inexpensive style for beginners to use
- Hurdle folds flat for easy transport and storage

1274509 \$54⁹⁹ EA ★



**PORTaPiT[®]
JUNIOR TRAINING**

- Lightweight all anodized aluminum construction
- Includes PVC hurdle board and nylon breakaway gate with hook-and-loop grip
- Rocker design will automatically right itself
- Instant locking at 5 heights: 22", 24", 26", 28" and 30"
- Weight: 10 lbs.

AJEVXXX \$66⁹⁹ EA ★
AVELCROS \$5⁹⁹ EA ★
Nylon Breakaway Gates

HURDLE CARTS



FLIGHT HURDLE CART

- Sturdy steel construction with black powder coated finish
- Four wheel design provides superior moveability
- Designed for "L" shaped hurdles only
- Holds 8-10 hurdles

GA4630 \$299⁹⁹ EA ★



2-WHEEL HURDLE CART

- Steel construction with durable black powder coat finish
- Compatible with "L" shaped hurdles only
- Holds 8-10 hurdles

GA4210 \$329⁹⁹ EA ★



HURDLE TRANSPORT CART

- Steel construction with durable black powder coated finish
- Large swivel casters for easy transportation
- Compatible with both rocker and "L" shaped hurdles
- Holds 15-20 hurdles

GA4020 \$699⁹⁹ EA ★



PORTaPIT®

RISERS AVAILABLE IN:

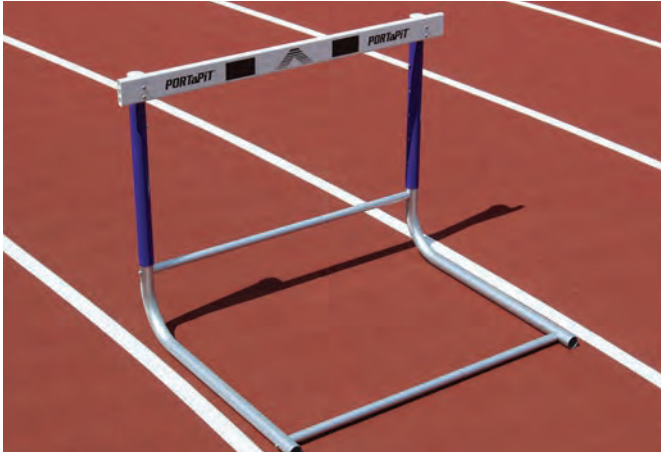

COMPETITION ROCKER

- Meets NFHS specifications
- Lightweight, high quality anodized aluminum alloy
- Impact absorbing PVC gateboard

GAHSRX

Specify Riser Color

\$176⁹⁹ EA ★



HIGH SCHOOL ALUMINUM

- Meets NFHS specifications
- Lightweight, high quality anodized aluminum alloy
- Impact absorbing PVC gateboard

GAAFURY

Specify Riser Color

\$122⁹⁹ EA ★

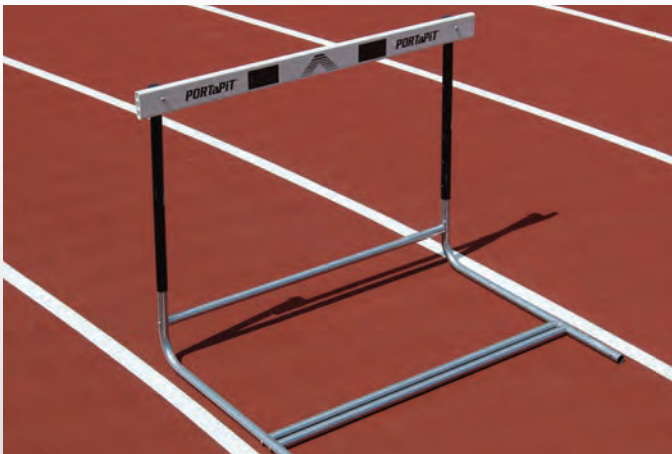

HIGH SCHOOL STEEL

- Meets NFHS specifications
- Strong, all steel construction
- Impact absorbing PVC gateboard

GAHSST

Specify Riser Color

\$107⁹⁹ EA ★



ADVANTAGE

- Meets NFHS and NCAA specifications
- Strong high quality mill finish aluminum
- Concealed EZ glide weights to meet official pullover standards

GAADVA

Specify Riser Color

\$224⁹⁹ EA ★



STANDARD HURDLE BOARD PRINTING

Standard printing on boards, 1-color with block lettering

GA945

59 Hurdles or Less/per order

\$45⁰⁰ PER ORDER

CUSTOM HURDLE BOARD PRINTING

Custom printing on boards, up to 4-colors with logo

GA946

59 Hurdles or Less/per order

\$70⁰⁰ PER ORDER

FREE OFFER!!

Buy 60 hurdles or more and we will place custom lettering on the hurdle board at no charge. Put your mascot or event title on your hurdles! No set up fee. Please supply your artwork.



ELITE

- Meets NFHS, NCAA and IAAF specifications
- Strong high quality mill finish aluminum

GAAFRLH

Specify Riser Color

\$254⁹⁹ EA ★

NJ State Approved Co. on #65MCE-SC-035. Metuchen/Garden State Apparel Bid Term: 5/9/18 - 5/8/20. Extended to 5/8/21

DISCS



HOLLOWOOD STAR

- Recommended for all levels
- Straight grained hard rock maple side plates
- High quality steel rim, up to 75% rim weight
- Meets High School, NCAA, and IAAF specifications

GA300	2K	\$359 ⁹⁹ EA
GA305	1.6K	\$339 ⁹⁹ EA
GA313	1K	\$309 ⁹⁹ EA



RED

- ABS plastic side plates
- High quality steel rim
- Up to 80% rim weight
- Meets High School, NCAA, and IAAF specifications

GA303	2K	\$129 ⁹⁹ EA
GA309	1.6K	\$109 ⁹⁹ EA
GA312	1K	\$89 ⁹⁹ EA



**PORTaPiT[®]
GOLD LO-SPIN DISCUS**

- Silver Medal winner at the 1996 Games in Atlanta
- Designed for beginner and intermediate throwers
- Constructed of High-impact ABS plastic side plates with a steel rim
- 75% rim weight
- Meets NFHS specifications

ADLSHSGD	1.6K	\$79 ⁹⁹ EA ★
ADLS1KGD	1K	\$74 ⁹⁹ EA ★



**PORTaPiT[®]
CHALLENGER DISCUS**

- Plastic plated discus
- Priced for general purposes practice or dual meet competition
- 73% rim weight
- Meets NFHS specifications

1101386	1.6K	\$49 ⁹⁹ EA ★
1101393	1K	\$47 ⁹⁹ EA ★



**PORTaPiT[®]
WOOD**

- Economy wood discus with steel rim
- Ideal for competition as well as practice
- 60-70% rim weight
- Meets NFHS specifications

1101409	2K	\$38 ⁹⁹ EA ★
1101416	1.6K	\$36 ⁹⁹ EA ★
1101423	1K	\$34 ⁹⁹ EA ★



**PORTaPiT[®]
POPULAR WOOD**

- Center weighted solid wood discus is for the less experienced thrower
- Suggested for distances of 160ft or less this
- Made of fine rock maple with a matched steel rim
- Meets NFHS specifications

AWODD1.6	1.6K	\$44 ⁹⁹ EA ★
AWODD1.0	1K	\$39 ⁹⁹ EA ★



**PORTaPiT[®]
BLACK RUBBER - PRACTICE**

- Affordable hard rubber discus
- Excellent for training at the high school or middle school level.

ARD1.6XX	1.6K	\$12 ⁹⁹ EA ★
ARD1.0XX	1K	\$11 ⁹⁹ EA ★

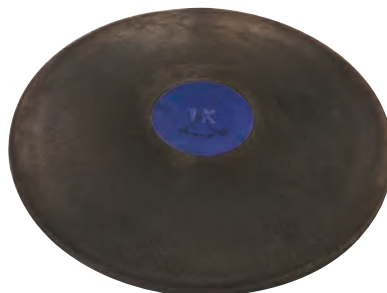

**PORTaPiT[®]
BLACK RUBBER - OFFICIAL**

- Molded to the official weight and specs
- Recommended for practice and official competition
- Meets NFHS specifications

1101430	2K	\$14 ⁹⁹ EA ★
1101447	1.6K	\$13 ⁹⁹ EA ★
1101454	1K	\$11 ⁹⁹ EA ★



**PORTaPiT[®]
BROWN INDOOR**

- Special non-marring brown rubber that reduces marks on gym floor
- Meets official weights and specifications
- 78% rim weight

ATFID1.6	1.6K	\$13 ⁹⁹ EA ★
ATFID1.0	1K	\$11 ⁹⁹ EA ★

Bid #ESCNJ 17/18-31

Educational Services Commission of New Jersey

Athletic Equipment & Supplies

PORTaPIT®

TRACK



BRASS

- Lathe turned to minimum diameter allowed in competition
- Machine finished for excellent grip and calibrated to exact weight
- Unsurpassed quality
- Meets all Collegiate, International & High School Federation specifications

ABSHOT12 115mm 12lbs \$152.99 EA ★

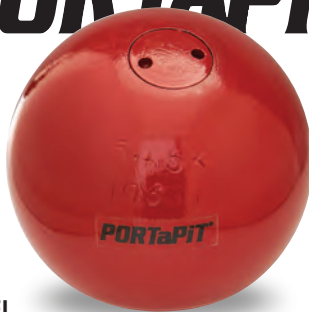

STEEL

- Solid steel shot for the advanced thrower
- Machine turned to different diameters
- Lathe turned and balanced for an overall best performance
- Polyurethane paint coated for smooth and durable finish
- Meets NFHS specifications

1101508 103mm 12 lbs \$99.99 EA ★

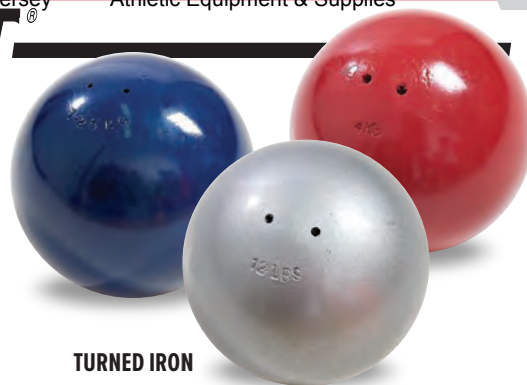

TURNED IRON

- Solid cast iron shot
- Machine turned to different diameters
- Balanced for high performance throws
- Meets NFHS specifications

AFSHOT16 16 lbs-Blue \$74.99 EA ★
AFSHOT12 12 lbs-Silver \$56.99 EA ★
AFSHOT4K 4K-Red \$51.99 EA ★



SHOT AND DISCUS CARRIER

- Water resistant polyester carrier holds two discus, two shots or one of each
- Comes with shoulder strap for easy transport

ASDCXXXX \$12.99 EA ★



SCHOLASTIC

- Cast iron weight shot
- Great for high school/middle school practice
- Priced to fit your budget

ARSHOT12 12 lbs \$23.99 EA ★
ARSHOT4K 4K \$22.99 EA ★
1101591 8 lbs \$19.99 EA ★
1101614 6 lbs \$17.99 EA ★



INDOOR

- High visibility red indoor shot has that outdoor shot feel
- Soft enough not to mark or damage the gym or indoor facility floor
- Meets all Collegiate, International & High School Federation specs

6048XXXX 4K \$44.99 EA ★
6082XXXX 12lb 5.44K \$54.99 EA ★



COMBO IMPLEMENT CART

- Implement Cart to hold shots, discus, and hammers
- Rolling wheels

GA9312 \$699.99 EA



FIELD DISTANCE MARKERS

- Markers used to measure competitor's throws
- Chalk may be used to write competitor's name and numbers
- Extremely durable

1101645 \$45.99 DZN ★



BSN SPORTS

GYM CHALK

- For weight-lifting or gymnastics
- Conveniently wrapped in 2 oz. blocks
- Eight blocks per 1 lb. package

PGE4360X \$16.99 LB ★

Gym Chalk
 Carbonate
 One Pound

BSN SPORTS

PORTaPiT®



COMPETITION 13' 6" DISCUS CAGE

- All aluminum high school discus cage with 6 permanent in-ground sleeves and 4" square posts.
- Comes complete with sleeve caps.
- Meets High School specification.
- Special pulley system allows easy daily removal of netting.
- 30" cantilever post for Offset netting provides for maximum protection.
- Net is 1-3/4" weather treated nylon with weighted bottom.
- Includes spectator warning signs.

4 Year Limited Warranty

AHSDCAGE		\$2,899⁹⁹ EA ★
SNHSDNET	Replacement Net-13' H x 54' L	\$499⁹⁹ EA ★



HIGH SCHOOL DISCUS CAGE

- Aluminum poles: 2 7/8" outside diameter with rolled offset for safety
- Steel poles: 2 1/2" square A513 with rolled offset for safety
- Net: 180 lb breaking strength
- Net height: 13' 6"
- Meets NFHS specifications

GA8010	6-Pole Cage-Aluminum	\$3,299⁹⁹ EA
GA8030	6-Pole Cage-Steel	\$3,199⁹⁹ EA
GAM2055	Cage Net	\$769⁹⁹ EA
GA80102	Barrier Netting for Alum Cage	\$449⁹⁹ EA
GA80302	Barrier Netting for Steel Cage	\$449⁹⁹ EA



PRO DOWN DISCUS CAGES

- Consists of six galvanized 2 3/8"OD, 12 gauge steel upright poles
- Five galvanized steel top rungs helps eliminate neg sag
- The knotless weather treated nylon net has a breaking strength of 180 lbs.
- Comes with ground sleeves, Net Height: 10' 6"

GA80401	Cage with Ground Sleeves	\$1,999⁹⁹ EA
GA80402	Cage with Plates	\$3,099⁹⁹ EA
GA80405	Replacement Net	\$1,199⁹⁹ EA



HIGH SCHOOL PORTABLE DISCUS CAGE

- Designed for set up or removal as needed
- Poles: (6) 6063-T6 aluminum net poles
- Net is #504 knotless nylon with 180 lb breaking strength
- Net height: 13' 6"
- Bases: A500 Grade B steel with wheels for transportability and weighted with 5 gallon jugs to be filled with sand or water

GA732220	Cage	\$7,999⁹⁹ EA
GAM2055	Cage Net	\$769⁹⁹ EA



SHOT CAGE

- Poles: (4) 6063-T6 aluminum or A513 steel
- Net is weather treated nylon 6 net with 180 lb breaking strength
- Net height: 13' 6"
- 18" hinged net arms secure net at front two poles with ground stakes used at back poles
- 20" deep ground sleeves

GA8050	Steel Cage	\$2,999⁹⁹ EA
GA805	Shot Cage	\$2,449⁹⁹ EA
GAM2054	Cage Net	\$749⁹⁹ EA

DISCUS/SHOTS CIRCLES



GILL ATHLETICS STEEL DISCUS CIRCLE

- Three sections of 1/4" x 1 1/2" flat powder coated steel
- Designed to be mounted on top of concrete surface
- Anchor bolts included
- Meets NFHS specifications

GA371 \$289⁹⁹ EA



SHOT/DISCUS CIRCLES

- Aluminum angled construction
- Made of 1" x 3/4" x 1/4 aluminum
- Comes in 4 sections with anchoring holes

1376585 Shot Circle-10 lbs \$199⁹⁹ EA
 1376586 Discus Circle-10 lbs \$209⁹⁹ EA



GILL ATHLETICS ALUMINUM CIRCLES

- Four sections of 1" x 3/4" extruded aluminum angle
- Designed to be cast into concrete
- Discus circle can also be mounted to surface
- Compatible with toeboards GA358, GA363
- Meets NFHS, NCAA and IAAF specifications



GA369 Shot/Hammer \$239⁹⁹ EA
 GA370 Discus \$239⁹⁹ EA



GILL ATHLETICS STEEL SHOT CIRCLE

- Four sections of 1/4" x 1 1/2" flat powder coated steel
- Designed to be mounted on top of concrete surface
- Anchor bolts included
- Compatible with toeboards GA359, GA364
- Meets NFHS specifications



GA373 \$259⁹⁹ EA

TOE BOARDS



SHOT TOE BOARD

- Polyethylene board shaped to meet official specs
- Super-strong and weather resistant
- Formed holes at each end for securing

1126143 Plastic Poly Board \$189⁹⁹ EA ★



GILL ATHLETICS SYNTHETIC SHOT TOEBOARD FOR DEPRESSED PAD

- Molded low density polyethylene designed for 3/4" depressed surface
- Compatible with circles GA369
- Meets NFHS, NCAA and IAAF specifications

GA358 \$349⁹⁹ EA



GILL ATHLETICS SYNTHETIC SHOT TOEBOARD FOR LEVEL PAD

- Molded low density polyethylene designed for surface mount shot circles
- Compatible with circles GA373
- Meets NFHS specifications

GA359 \$349⁹⁹ EA



GILL ATHLETICS ALUMINUM SHOT TOEBOARD FOR DEPRESSED PAD

- Cast aluminum designed for a 3/4" depressed surface
- Compatible with circles GA369
- Meets NFHS, NCAA and IAAF specifications (IAAF certified)

GA363 \$529⁹⁹ EA



GILL ATHLETICS ALUMINUM SHOT TOEBOARD FOR LEVEL PAD

- Cast aluminum designed for surface mount shot circles
- Compatible with circles GA373

GA364 \$529⁹⁹ EA

VAULT BOXES

TAKE OFF BOARDS



GILL
ATHLETICS

ALUMINUM VAULT BOX

- Welded aluminum construction
- Meets High School and NCAA specifications
- IAAF certified

GA502 \$519⁹⁹ EA **SeH**



STEEL VAULT BOX

- 12 gauge steel construction
- 105 degree angle on front
- Meets HS, Collegiate, and International Standards

ASTLVBOX \$199⁹⁹ EA

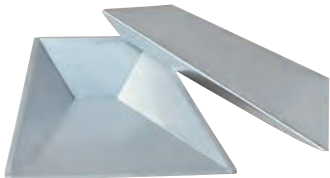

ALUMINUM VAULT BOX WITH LID

- Rust-resistant 1/8" aluminum
- 105 degree angle on front
- Meets HS, Collegiate, and International standards

AAALMVBOX \$569⁹⁹ EA



NEW!
GILL
ATHLETICS

SLIDING VAULT BOX

- Sliding vault box allows vaulters to perfect the run, plant, and take-off
- Pole carriage, run mechanics, tempo, and step placement are more effectively learned using this training tool
- Constructed of high impact thermoplastic, same size as regular vault box
- To be used as a training aid, not to be used as vault box in meets

GA2531 \$579⁹⁹ EA **SeH**



COLLEGIATE/HIGH SCHOOL TAKE OFF BOARD

- Made of laminated wood
- Sealed, primed, and finished with white enamel paint
- Meets High School and Collegiate specs

1200485 2.5"H x 8"W x 48"L \$199⁹⁹ EA

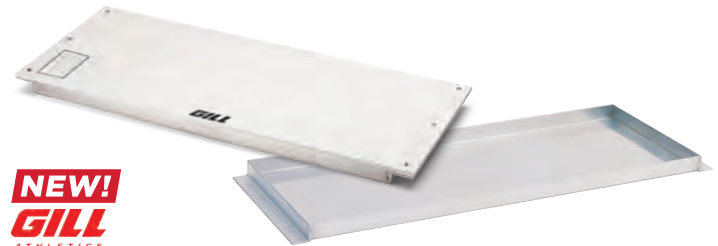

NEW!
GILL
ATHLETICS

HIGH SCHOOL TAKE-OFF BOARD SYSTEMS

- 19.5" Take-Off board system
- Complete system: Installation tray, aluminum base board, reversible take-off board
- Meets NFHS specifications

GA441T	Complete HS System-Wood	\$639 ⁹⁹ SET
GA44105	Replacement Take Off Board	\$139 ⁹⁹ EA
GA441	Take-Off Board w/ Base-Wood	\$289 ⁹⁹ EA
GA442	Replacement Installation Tray	\$449 ⁹⁹ EA



100 FT. PENNANT STREAMER

- Rope streamers with 18" nylon cloth pennants in a variety of colors: Blue, Green, Red, White and Yellow
- Use to dress up your field, crowd control or for cross-country events
- Sold in lengths of 100' (approx. 48 flags per 100')

1260XXXX Streamers \$17⁹⁹ EA ★

MEASURING WHEELS



FIBERGLASS MEASURING TAPES

- Durable, long-lasting, vinyl-coated fiberglass tapes in ABS shatter resistant case
- Closed reel tapes feature an easy to wind, flush-folding handle
- Open reel tapes feature easy to wind return, handle and shoulder strap
- Printed with inches/feet on one side and centimeters/meters on the other
- Includes end-loop for one-person measuring

1. MSTAP50X	50'-15M	\$15 ⁹⁹ EA ★
2. MSTAP100	100'-30M	\$19 ⁹⁹ EA ★
3. MSTAP165	165'-50M	\$26 ⁹⁹ EA ★
4. MSTAP200	200'-60M	\$39 ⁹⁹ EA ★
5. MSTAP330	330'-100M	\$47 ⁹⁹ EA ★

MEASURING WHEELS

- All steel construction
- Measures up to 100,000 in feet, inches and tenths or meters, centimeters and decimeters
- Wheel circumference = 4' English and 1 Meter Metric
- Features wheel brake - transport to another site without losing existing measurement



MSTRKMWM Metric Measurements \$244⁹⁹ EA



ECONOMY MEASURING WHEEL

- Lightweight and extremely durable
- Measures in English up to 10,000 feet

1378131 \$99⁹⁹ EA ★

LAP COUNTER WITH BELL

- Easy to read numbers mounted in an aluminum frame
- Each number goes from 0-9
- Sturdy, lightweight and easy to move

AFLCBXXX \$469⁹⁹ EA



PERFORMANCE INDICATOR-4 DIGIT

- Four digit indicator
- Aluminum construction with steel base
- Transport wheels

AFPIXXXX \$569⁹⁹ EA



TRACK/FIELD SCOREBOOK

- NFHSSA® High School Track/Field Scorebook
- Includes enough pages for full season of meets
- Spiral-bound

1372413 \$14⁹⁹ EA

NEW!

Robic TIMING CLIPBOARD

- Clipboard with stopwatch and calculator
- Stopwatch and calculator can be run simultaneously
- Solar or battery powered
- Dimensions: 14"H x 9"W



1188288 \$34⁹⁹ EA

NEW!

ULTRAK... ELECTRONIC STARTING PISTOL

- Three different starting tones: gun fire, beep and whistle
- High visibility strobe light flashes with starting sound
- Can simultaneously start Ultrak L10 Timer and is compatible with FinishLynx
- Portable amp can be used as a microphone or loud speaker
- Amp has a maximum 20 watt power output with volume control
- Amp includes rechargeable lithium battery with 8 hours of use when fully charged



1397631 Complete Set (Pistol, amp, headset, carry bag) \$299⁹⁹ SET

1397632 Pistol/bag Only \$229⁹⁹ SET



RACE CLOCKS

- Six digit race clocks with 9" tall digits
- Count up/count down capability in seconds or hundredths of seconds
- Powered by 120V AC or external 12V battery
- Tripod and small remote control included with all race clocks (end mounted controls for direct operation)

1384907	9" Digit Race Clock	\$2,899 ⁹⁹ EA
1384908	Carrying Case	\$629 ⁹⁹ EA
1384909	Double-Sided Race Clock	\$3,799 ⁹⁹ EA
1384910	12V Battery	\$76 ⁹⁹ EA



JUDGES STAND

- Measures 4'W x 9.5'D x 7'H
- Seats 10-people or 20-people can stand
- Handrail for top three levels
- 8"D wheels for transport.

AATRACKS \$1,099⁹⁹ EA



ROLLOUT RUNWAY

- Our 10mm rollout runway installs in seconds with no bonding necessary.
- Solve your runway problems and protect your track
- Available in 30", 36", 42" and 48" widths.
- Roll up after use for easy transportation and storage.

AFRUN10M \$4⁹⁹ SQ.FT



LANDING ZONE™ PIT COVERS

- Landing Zone ballasted pit protectors keeps sand in...even in high winds, but keeps cats and kids out.
- Steel chain edge hem all around keeps protector down in high winds.
- All units are made to the specific size ordered.
- Pit will not stay dry in the event of rain!
- Add 2' to each dimension so the protector extends over the pit and onto the track.
- Colors: Black, Dk Green, Maroon, Navy, Red, Royal, Orange, White, Yellow

1298024 Vinyl Polyester Material \$2⁹⁹ SQ.FT



ECONOMY STOPWATCH

- Single event watch
- 1/100 second precision with lap counter (1st 30 minutes)
- Beep, beep alarm with chime and snooze
- 12/24 hour display option
- Count up to 23 hrs, 59 min., 59 sec.
- Detachable lanyard

1266702 Black \$8⁹⁹ EA ★
1266696 6 Color Pack \$54⁹⁹ PACK OF 6 ★



106L STOPWATCH

- Single events and time outs
- Cumulative splits, 1-2 Fast Finish
- 1/100 second with lap
- Daily alarm and hourly chime

1269062 Black \$10⁹⁹ EA ★
1269079 8 Color Pack \$74⁹⁹ PACK OF 8 ★



K-350 STOPWATCH

- 100 Lap and split memory with 1/100 second precision
- Individual lap time, total time, fastest lap, average lap time calculation
- Two individual daily alarm
- Two row time, date, and day display

5 Year Limited Warranty

1376386 \$26⁹⁹ EA ★



K-250 STOPWATCH

- 30 laps and split memory with 1/100 second precision
- 2 line display
- Fastest lap and slowest lap calculation
- Countdown timer

5 Year Limited Warranty

1376385 \$19⁹⁹ EA ★



K-150 STOPWATCH

- 1/100 second precision with lap counter (for the first 30 minutes)
- Calendar and Time display(12/24 hr format)
- Daily alarm
- Hourly chime

5 Year Limited Warranty

1376384 \$17⁹⁹ EA ★



601X STOPWATCH

- Times single event and cumulative splits
- Large digits for easy viewing
- 1-2 fast finish, 30 minute range
- 5 year "no proof" warranty

12440191 \$18⁹⁹ EA



AX725 STOPWATCH

- 16 Dual split memory
- Dual split (lap & cum)
- 1 Button rapid split and reset
- 10 hour range
- Water resistant
- 5-year battery life

MSSTP725 \$26⁹⁹ EA

Robic



SC-505W STOPWATCH

- 12 Memory Chrono
- Time events up to 24 hours in 1/100 second resolution
- 12 Memory recall
- Automatic lap count to 199



SC-500-E STOPWATCH

- One-step timing for all events
- Start/stop/reset operation
- Water resistant to 30 meters
- Audible beep confirmation or silent operation
- Ideal for finish line volunteers or lane monitor timing



SC-877 TRAINING TIMER

- 180 Dual Memory recall and a total reading capacity of 1000 times
- Memory recall can be ascending or descending order
- Program up to 3 countdown timers to operate independently or simultaneously

MSSTP505	Black	\$28.99 EA
1240283	6 Color Pack	\$169.99 SET
1451079	Red	\$28.99 EA
1451080	Yellow	\$28.99 EA
1451081	Blue	\$28.99 EA

1378161

\$21.99 EA

1389753

\$53.99 EA

ULTRAK

460SET 16 MEMORY STOPWATCHES

- 16 lap or cum split recallable memory
- Recall and take splits during operation
- Lap counter to 99
- Water resistant
- Set includes six stopwatches (one each of blue, green, orange, purple, red and yellow)



5 Year Limited Warranty

1380590 Set of 6 \$139.99 SET

499 STOPWATCH & PRINTER

- Stopwatch system with a portable printer
- 500 lap dual memory that stores lap and cumulative times
- Events are kept in memory segmented by date and run number; all data can be printed out or printed after event
- Dual countdown timer and automatic split release



5 Year Limited Warranty

MSSTP499SP \$369.99 EA
MSSTPP25 EXTRA PRINTER PAPER ROLLS-Box of 25 \$54.99 BOX OF 25

360 STOPWATCH

- 30 dual splits recallable memory
- Lap/cumulative splits
- Recalls times forwards/backwards
- Measures to 10 hours, time and calendar, alarm
- Comes with lithium battery

1151824 \$28.99 EA

3 Year Limited Warranty

L10 8-LANE TIMER

Road Race (Cross Country) Mode

- 8,000 memory for individual finishers in single or multiple events
- Four digit bib numbers, four digit place counter
- Bib number entry at finish or add/edit after event
- Automatic print out during event
- Single and multiple start times, up to 99 waves in multiple start race

Track Race Mode

- 8 lap/split lane buttons
- Linkgate allows single wire to lane timer, eliminates tangled wires
- 8,000 dual split memory for single or multiple events
- Four digit bib numbers

Automatic printout of date, run number and record type



1151794 \$49.99 EA
1151800 Thermal Paper for L10-Box of 3 \$24.99 BOX OF 3



495 STOPWATCH

- 100 dual split recallable memory
- Takes splits from within recall mode
- Time, calendar and alarm
- Water resistant; lithium battery

5 Year Limited Warranty

1151827



NEW!

BTS STOPWATCH

- Bluetooth stopwatch with Smartphone app
- Compatible with both Apple and Android smartphones
- Multiple event/segment memory records and recalls
- User profile creation with data keeping and memory recall
- Stopwatch can measure up to 10 hours in 1/100 second
- Supports iOS 7.0 or above, supports bluetooth 4.0 or above

1397733 \$79.99 EA



340 STOPWATCH

- Display of cumulative splits
- Large numerical display
- Time, calendar, alarm
- Water resistant; lithium battery
- Comes with lithium battery

1151830 \$18.99 EA

TRACK

GAME BALLS



Wilson
I-COR HIGH PERFORMANCE

- Japanese full-grain leather cover
- i-COR construction
- Latex Power lining
- Indoor use only



1335682	White	\$67 ⁹⁹ EA
1384918	Red/White/Blue	\$67 ⁹⁹ EA



SPALDING
TF-VB5

- Select Japanese leather cover
- 2-ply soft cloth lining inside
- Floating butyl bladder
- Indoor use only



1375652		\$65 ⁹⁹ EA
---------	--	-----------------------



molten
NCAA
Super Touch

- Premium Japanese leather cover
- Uni-bladder cotton wrapped construction
- Official volleyball of the NCAA® Women's Championships

1273656		\$64 ⁹⁹ EA
---------	--	-----------------------



molten
Super Touch
Select Leather

- Premium Japanese leather cover
- Uni-bladder cotton wrapped construction
- NFHS approved



1376587	Royal/Silver/White	\$62 ⁹⁹ EA
1273663	White	\$62 ⁹⁹ EA



TACHIKARA
SV-5WSC "SENSI-TEC"® COMPOSITE

- All colors are NFHS approved



1072266	Specify Color	\$41 ⁹⁹ EA
---------	---------------	-----------------------



TACHIKARA
SV-5S "SENSI-TEC"® COMPOSITE

- Sensi-Tec™ micro-fiber composite leather cover
- Patented Loose Bladder Construction (LBC)™
- Hand finished panels and seams
- Indoor use only



TACSV5S	White	\$39 ⁹⁹ EA
---------	-------	-----------------------



TACHIKARA
SV-5W GOLD LEATHER

- U.S. Premium leather cover
- Patented Dual Bladder Construction (DBC)™ for a more responsive and controlled touch
- Impact reducing air layer buffers and evenly disperses force of digs, passes and spikes
- Indoor use only



TACSV5WX	White	\$64 ⁹⁹ EA
1050912	Red/White/Blue	\$64 ⁹⁹ EA



TACHIKARA
SV-5WM LEATHER

- Perfect value for practice in team white or team colors
- Full Grain Leather cover
- Indoor use only
- Color Options: Collegiate Blue/White/Silver, Scarlet/White/ Black, Scarlet/White/Royal, White.



1371299	Specify Color	\$39 ⁹⁹ EA
---------	---------------	-----------------------



Baden
PERFECTION®

- Top-Grade leather cover
- Total Feel Technology™
- Indoor use only



1301311	White	\$69 ⁹⁹ EA
1323108	Blue/White/Gray	\$69 ⁹⁹ EA
1376345	Red/White/Blue	\$69 ⁹⁹ EA



SPALDING
AAU LEATHER

- Select Japanese leather cover
- 2-ply soft cloth lining for improved structural integrity
- Floating butyl bladder
- Designed for Indoor play



UNDER ARMOUR
595

- Performance composite cover
- 100% butyl bladder, floating bladder construction
- Indoor match play



1393400		\$44 ⁹⁹ EA
---------	--	-----------------------



MIKASA SPORTS
VQ2000

- Microcell composite leather cover
- "Accu-Balance" true shape retention
- Indoor use only
- 2 Year Limited Warranty



VBVQ2000		\$44 ⁹⁹ EA
----------	--	-----------------------

INDOOR

MacGregor
X660 SOFT TOUCH

- Full grain cowhide leather cover
- Competition game ball
- True balance technology
- Indoor use only
- **2 Year Limited Warranty**

MCV660WH

\$39⁹⁹ EA ★



MARK 1 VOLLEYBALL

NFHS[®] APPROVED

- Japanese cordley composite leather cover
- Microfiber backing for soft touch feel
- Floating bladder
- Indoor use only

1235593

\$37⁹⁹ EA ★

TOURNAMENT TESTED!



MacGregor
X600 COMPOSITE

- HQ Composite leather cover
- Soft touch technology
- Floating bladder
- Indoor use only
- **2 Year Limited Warranty**

MCV600WH

\$28⁹⁹ EA ★



YMCA HERITAGE VOLLEYBALL

- Soft touch high quality composite leather cover
- Official size and weight

1384328

\$27⁹⁹ EA ★



MacGregor

X1000 GAME COMPOSITE

NFHS[®] APPROVED

- Soft composite leather cover
- Floating bladder construction
- Available in 7 colors
- Indoor/Outdoor use

Color Options: Black/White, Navy/White, Royal/White, Scarlet/White, Scarlet/White/Black, Scarlet/White/Royal, White.

MCV1000W

Specify Color \$33⁹⁹ EA ★



MacGregor
XL20 COMPOSITE

- Composite leather cover
- Exclusive shape retention bladder
- Indoor use only

2 Year Limited Warranty

Color Options: Navy/White, Royal/White, Scarlet/White, White.

MCVL20WH

Specify Color \$22⁹⁹ EA ★

Voit

SOFT TRAINING VOLLEYBALL

- Soft and light training volleyball
- Regulation size but lighter weight for beginners
- Indoor use only

1392604

Royal \$19⁹⁹ EA ★

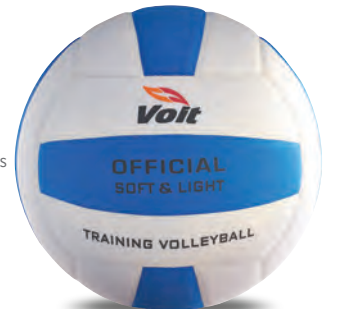

RUBBER



MacGregor
X300 RUBBER COVER

- Airtec Open Cell molded rubber cover allows for a thicker rubber without additional weight
- Smoother and softer feel with increased gripability
- Indoor/Outdoor use

1272772

\$11⁹⁹ EA ★



Voit
CV4 "SOFT SHOT" STINGLESS

- "Sting-free" Syn-Tec® rubber cover
- Special foam coating makes it durable and soft
- Indoor/Outdoor use

VCV4HXXX

\$14⁹⁹ EA ★



Voit
V5RWB RUBBER COVER

- Molded composition rubber cover
- Nylon wound bladder
- Indoor/Outdoor use

1272765

\$9⁹⁹ EA ★



Voit
V5 RUBBER COVER

- Molded composition rubber cover
- Nylon wound bladder
- Indoor/Outdoor use

VV5HXXXX

\$7⁹⁹ EA ★

TRAINING



- Sensi-Tec® microfibre composite cover
- Regulation size but lighter weight for younger players
- Helps develop novice players skills faster
- Indoor use only

20011575	White	\$37 ⁹⁹ EA
1050905	Scarlet/White/Royal	\$37 ⁹⁹ EA
1155549	Additional Colors	\$40 ⁹⁹ EA



ADDITIONAL COLOR OPTIONS

PRACTICE



SV-18S COMPOSITE

- Woven-fiber v100 composite
- Single Unit Construction (SUC®)
- Indoor use only

1233124

\$36⁹⁹ EA



Voit LIGHT SPIKE

- Double knit soft polyester fabric cover allows players to practice skills without discomfort
- 30% lighter than official volleyball
- Ideal trainer for developing fundamentals safely

1342536	\$13 ⁹⁹ EA ★
---------	-------------------------

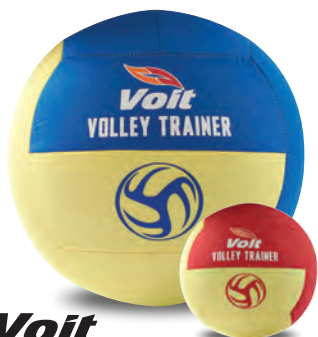

Voit BUDGET VOLLEY TRAINER®

- Sponge-like vinyl cover
- 18% larger and 12% lighter than an official volleyball
- Economical training ball

VVBBUDVT	Blue/Yellow	\$18 ⁹⁹ EA ★
1297911	Red/Yellow	\$18 ⁹⁹ EA ★



Voit ENDURO VOLLEY TRAINER®

- Non-sting synthetic cover
- 18% larger, 12% lighter than standard ball
- Great ball for developing quickness and control

VVBEVOLL	Yellow	\$24 ⁹⁹ EA ★
----------	--------	-------------------------



TACHIKARA TB-18 "THE SETTER"™

- Sensi-tec® micro-fiber composite cover
- Weighted ball builds hand/finger strength
- Weight: 15.7 - 17.5 oz.
- Indoor use only

1091991	\$47 ⁹⁹ EA
---------	-----------------------

CARTS



TACHIKARA HAMMOCK BALL CART

- Tubular galvanized steel frame
- Low profile design makes it easy to turn, reach & spike
- Collapsible unit that stores in carry bag (Included)
- Holds 24 balls
- 48"L x 22"W x 12"D x 40"H - 13 lbs.

Color Options: Black, Navy, Royal, Scarlet

1155389	Specify Color	\$154 ⁹⁹ EA
---------	---------------	------------------------



BSN SPORTS

E-Z FOLD CART

- Aluminum square frame
- Nylon top with mesh bottom
- Holds 20 basketballs or 30 volleyballs
- Non-marring swivel casters
- Folds to only 6" wide for easy storage

Bid Term: 5/9/18 to 5/8/20: Extended to 5/8/21



TACHIKARA

VB7500

- "Super Soft" composite leather cover
- Machine stitched reinforced seams
- Indoor/Outdoor use

1387791	Scarlet/Royal/White	\$34 ⁹⁹	EA
1245509	Gold/White/Blue	\$34 ⁹⁹	EA

SPALDING

AAU KOB

- Hand-stitched all-weather microfiber composite cover
- Official Size and Weight
- Designed for professional/competitive outdoor play

1398288	Red/White/Blue	\$45 ⁹⁹	EA
---------	----------------	--------------------	----

Wilson

SOFT PLAY

- Machine sewn with synthetic leather cover
- Excellent air and shape retention
- Indoor use only

1014167		\$15 ⁹⁹	EA
---------	--	--------------------	----



TACHIKARA

VX2

- Sof-Tec foam-backed panel volleyball
- Machine-stitched construction
- Butly bladder
- Ideal for camps, P.E. and recreational

1388863	White	\$19 ⁹⁹	EA
1388864	Royal/White/Yellow	\$19 ⁹⁹	EA

Voit

SANDSTORM II

- PU synthetic cover
- Machine sewn panel construction
- Indoor/Outdoor use

1297935		\$21 ⁹⁹	EA *
---------	--	--------------------	------

Voit

SANDSTORM

- Soft, synthetic leather cover
- Machine sewn panel construction
- Indoor/Outdoor use

1262650		\$15 ⁹⁹	EA *
---------	--	--------------------	------

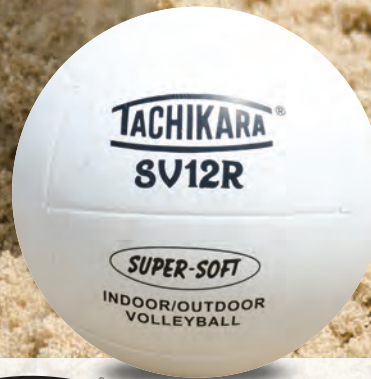

Voit
SMOOTH GRIP

- Smooth textured PU cover
- Machine sewn panel construction
- Indoor/Outdoor use

TACHIKARA

SV12R "SUPER-SOFT"

- "Super-Soft"™ rubber cover preferred by younger players
- Nylon-yarn winding provides extra durability
- Indoor/Outdoor use



ALUMINUM VOLLEYBALL SYSTEM



- Aluminum lightweight telescoping post with superior strength
- Net heights are indicated for men's, women, juniors on viewing window of pole, so pin adjustment can be set at correct height
- Complete system includes: Red powder coated anodized aluminum 3.5" posts, worm drive ratchet, pole pads (specify color), ground sleeves with floor plates, ultimate VB net, antennae, judges stand and judges stand safety padding (specify color)

PR5000TS	Complete System	\$2,999 ⁹⁹	SET	★	S&H
PR5000A	System w/o Ground Sleeves	\$2,799 ⁹⁹	SET	★	S&H
PR5000X	System w/o Judge's Stand & Padding	\$2,399 ⁹⁹	SET	★	S&H
PR5000B	System w/o Judge's Stand/Padding & Ground Sleeves	\$2,199 ⁹⁹	SET	★	S&H
PR5000C	Center Standard & Pole Padding Only	\$1,599 ⁹⁹	SET	★	S&H
PRFLRPLT35	3.5" Ground Sleeves/Floor Covers	\$219 ⁹⁹	SET		
PR1235661	Universal Volleyball Net-Kevlar Top	\$299 ⁹⁹	EA	★	

PAD COLOR OPTIONS



BSN SPORTS VOLLEYBALL SYSTEMS-AT-A-GLANCE

X INDICATES THE FEATURE IS INCLUDED WITH THE SYSTEM

CODE	PRICE	U/M	RATCHET	ANTENNA	POLE PADS	NET	JUDGES STAND	JUDGES STAND PAD	GROUND SLVS/ FLOOR PLATES
ALUMINUM 3.5" OD									
PR5000TS	\$2,999 ⁹⁹	SET	X	X	X	X	X	X	X
PR5000A	\$2,799 ⁹⁹	SET	X	X	X	X	X	X	
PR5000X	\$2,399 ⁹⁹	SET	X	X	X	X			X
PR5000B	\$2,199 ⁹⁹	SET	X	X	X	X			
HYBRID 3" OD									
PR4000TS	\$2,599 ⁹⁹	SET	X	X	X	X	X	X	X
PR4000A	\$2,399 ⁹⁹	SET	X	X	X	X	X	X	
PR4000X	\$1,999 ⁹⁹	SET	X	X	X	X			X
PR4000B	\$1,799 ⁹⁹	SET	X	X	X	X			
STEEL 3.5" OD									
PR3000TS	\$2,299 ⁹⁹	SET	X	X	X	X	X	X	X
PR3000A	\$2,099 ⁹⁹	SET	X	X	X	X	X	X	
PR3000X	\$1,899 ⁹⁹	SET	X	X	X	X			X
PR3000B	\$1,599 ⁹⁹	SET	X	X	X	X			



VOLLEYBALL

HYBRID VOLLEYBALL SYSTEM



- Heavy duty steel outer upright with aluminum inner upright
- Telescoping standard with pin-stop preset heights
- Flat black powder coated finish
- Complete system includes: Flat black steel outer/aluminum inner 3" posts, worm drive ratchet, pole pads(specify color), ground sleeves with floor plates, ultimate VB net, antennae, judges stand and judges stand safety padding(specify color)

PR4000TS	Complete System	\$2,599 ⁹⁹	SET	★	
PR4000A	System w/o Ground Sleeves	\$2,399 ⁹⁹	SET	★	
PR4000X	System w/o Judge's Stand & Padding	\$1,999 ⁹⁹	SET	★	
PR4000B	System w/o Judge's Stand/Padding & Ground Sleeves	\$1,799 ⁹⁹	SET	★	
PR4000C	Center Standard/Pole Padding Only	\$1,099 ⁹⁹	SET	★	
PR1235661	Universal Volleyball Net-Kevlar Top	\$299 ⁹⁹	EA	★	
PRFLRPLT30	3" Ground Sleeves/Floor Covers	\$219 ⁹⁹	SET		
PR00827300	Sleeve Adapter-Converts 3.5" to 3"	\$139 ⁹⁹	EA		

PAD COLOR OPTIONS



STEEL VOLLEYBALL SYSTEM



- Heavy duty galvanized steel stationary uprights
- Chrome powder coated black gloss collars slide up/down for height adjustment
- Multi-sport system can be used for volleyball, tennis, or badminton
- Complete system includes: Flat grey galvanized steel 3.5" posts, worm drive ratchet, pole pads(specify color), ground sleeves with floor plates, ultimate VB net, antennae, judges stand and judges stand safety padding(specify color)

PR3000TS	Complete System	\$2,299 ⁹⁹	SET	★	
PR3000A	System w/o Ground Sleeves	\$2,099 ⁹⁹	SET	★	
PR3000X	System w/o Judge's Stand & Padding	\$1,899 ⁹⁹	SET	★	
PR3000B	System w/o Judges Stand/Padding or Ground Sleeves	\$1,599 ⁹⁹	SET	★	
PR3000C	Center Standard/Pole Padding Only	\$1,099 ⁹⁹	SET	★	
PRFLRPLT35	3.5" Ground Sleeves/Floor Covers	\$219 ⁹⁹	SET		
		\$299 ⁹⁹	EA	★	



FOLDING JUDGE'S STAND

- Free standing steel, portable judge's stand to use on any sleeved volleyball system
- Black powder coated finish with a grey vinyl padded platform
- Unit folds down enabling entire stand to be flat for storage
- Non-marking casters provide easy transport to any location

PR669100 \$429⁹⁹ EA ★



JUDGE'S STAND PADDING

- 1 3/8" thick polyethylene tube foam
 - 15oz. vinyl covering, available in 14 colors
 - Player protection from impact, easy to attach
- Color Options: **Black, Dk Green, Grey, Kelly, Light Blue, Maroon, Navy, Orange, Purple, Red, Royal, Tan, White, Yellow Gold.**

JUDGE'S STAND SOLD SEPARATELY.

PRJUDPAD Specify Color \$369⁹⁹ EA



EQUIPMENT NOT INCLUDED

VOLLEYBALL EQUIPMENT CART

- Constructed 1.5" 14-gauge powder coated steel tubing
- Storage basket is 8"D x 20"W x 5"L
- Transport and store up to 6 poles with other court accessories (balls, nets, pole pads, etc.)
- Includes 4 non-marring swivel casters
- 60"L x 32"W x 42"H

1197372 60 lbs. \$399⁹⁹ EA ★



STANDARD PADS

- 15oz vinyl cover, 1 3/8" thick polyethylene filler
- Hook/Loop attachments
- Pads are cut and hinged to fold neatly around uprights and ratchets to provide a clean look

PRSTAPAD End Pole Pads-Specify Color \$499⁹⁹ PR ★
 PRCTRPAD Center Pole Pad-Specify Color \$329⁹⁹ EA ★

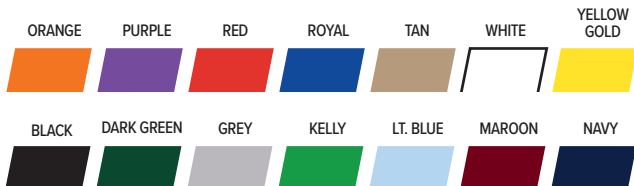

\$200 UPCHARGE POLE PAD GRAPHICS
\$150 UPCHARGE CENTER STANDARD PAD GRAPHICS
ON ALL PADS



POWR-RIB II INTERNATIONAL VB PKG

- Constructed of high strength, lightweight aluminum, easy for installation
- Standards are compatible with 3.5" diameter floor sleeves
- Package includes: Standards, protective pads, competition net 37'6" kevlar top cable net, antennas, net chain, judges stand, judges stand padding.

1376589 Specify Pad Color \$3,599⁹⁹ SET

POWR-LINE INTERNATIONAL VB PKG

- Telescopic extruded aluminum 3.5" posts design features a unique reinforcing rib pattern for superior strength
- Heavy duty pressure lock T-handle which allows for infinite settings
- Package includes: Standards, protective pads, competition net 42'6" kevlar top cable net, antennas, net chain, judges stand, judges stand padding

PR01981 Specify Pad Color \$4,199⁹⁹ EA



POWR-RIB II® ALUMINUM STANDARDS

- Posts are lightweight aluminum one piece design
- Features built-in channel with collar slides for height adjustment using a pressure lock T-handle with positive locking feature
- Includes visual labels for official men's, women's and junior height settings and Powr-Winch® net tensioning mechanism with positive disc brake release

P01971	3.5" Poles	\$1,599 ⁹⁹ PR
P01973	3" Poles	\$1,699 ⁹⁹ PR
PR1235661	Universal Volleyball Net-Kevlar Top	\$299 ⁹⁹ EA ★
PR02296100	POWR-Line Net Antennae	\$159 ⁹⁹ EA
PR02297000	POWR-Line Boundary Markers	\$69 ⁹⁹ PR



POWR-CARBON STANDARDS

- Powr-Carbon standard provides the lightest weight of any standard at 20lbs ea
- Features are 3.5" OD carbon sleeve, carbon inner upright, high gloss protective coating, tethered steel pin, lightweight pulley wheel, worm-drive net winch

PR2099	3.5" Poles	\$4,599 ⁹⁹ PR
PR1235661	Universal Volleyball Net-Kevlar Top	\$299 ⁹⁹ EA ★
PR02296100	POWR-Line Net Antennae	\$159 ⁹⁹ EA
PR02297000	POWR-Line Boundary Markers	\$69 ⁹⁹ PR

BLACK	DARK GREEN	GREY	KELLY	LT. BLUE	MAROON	NAVY	ORANGE	PURPLE	RED	ROYAL	TAN	WHITE	YELLOW GOLD
<p>NJ State Approved Co-op #65MCESCCPS Metuchen/Garden State AppareBid Term: 5/9/18 - 5/8/20: Extended to 5/8/21</p>													

SPALDING

ELITE ALUMINUM SYSTEM

The Elite Aluminum System is lightweight, durable and easy to set up. Meets all USAV, NCAA, NFHS and FIVB specifications. 10-year limited warranty on uprights.

- High strength uprights made of 3" OD extruded aluminum
- Adjustable height worm gear winch which eliminates backlash and gets net tight during play
- Nylon leader strap allows for safety and easy net attachment
- System includes: Winch end upright, center upright, 1M Aramid Fiber Net, antennae package, boundary tape, upright pads

10 Year Limited Warranty

1155334 \$3,699⁹⁹ SET

Upright Package

- Includes: winch end upright, center upright, antennae package and net boundary tape only

1139068 \$2,599⁹⁹ SET

Elite Aluminum Volleyball System

1M Kevlar Net for the Elite Aluminum Volleyball System

1143478 1M Aramid Fiber Net \$639⁹⁹ EA

Floor Plates/Sleeves

- Cover plate consists of chromed steel 6-3/4" (17cm) O.D. outer ring and hinged steel cap.
- Heavy-duty steel sleeve receives a 3" (76mm) O.D. upright and is 9-3/32" (23cm) long.

1139075 \$369⁹⁹ PR



SLIDE MULTI-SPORT SYSTEM

American Athletic's recreational volleyball equipment is built with value, ease-of-use and functionality in mind.

- High strength uprights made of 3" OD aluminum with sliding adjustments, continuous height adjustments.
- Nylon leader strap allows for safety and easy net attachment
- Adjusts for any height for use in volleyball, badminton, tennis
- Easily converts to two-court system
- System includes: Slide winch end upright, slide center upright, 36" Quick Set net, antennae package, boundary tape, upright pads.

5 Year Limited Warranty

1157642 \$2,999⁹⁹ SET

Upright Package

- Includes: slide winch upright and slide center upright only

1157659 \$1,999⁹⁹ SET

36" Quick Set Net

1157666 \$469⁹⁹ EA



MATCHPOINT ALUMINUM SYSTEM

- Maximum versatility, maximum value, heavy wall 3.5" aluminum extruded posts with powder coated finish
- Height adjust channel system with easy to read height indicators on both poles. Height variable from 42" to 96" for all levels of competition volleyball play, plus tennis, badminton, pickleball and other net games
- System includes: Poles, Kevlar top rope net, tensioning winch, antennae, pole pads (specify color) and 2 ground sleeves with brass floor plates

10 Year Limited Warranty

1263206 \$3,199⁹⁹ SET

Complete System Without Ground Sleeves

Complete Matchpoint System with 3.5" aluminum posts, net tensioning winch, Kevlar top rope net, antennae and pole pads (specify color)

1263213 \$2,599⁹⁹ SET



CENTERLINE ELITE ALUMINUM SYSTEM

- Centerline aluminum systems are designed to provide the bowstring tight net tension insisted on by top programs without extra weight
- Centerline system height adjustment is made easy with Auto Track spring assisted telescoping piston design. Height variable from 72" to 96" with easy-to-read height adjustment indicators
- The powder coated standards and winch are covered by a limited lifetime warranty
- System includes: 3" aluminum telescoping poles, net tensioning winch, Kevlar top rope net, Centerline antennae, two 1 1/2" thick x 72"H pole pads (specify color), cable covers and 2 ground sleeves with brass floor plates
- Call for assistance if your existing sockets
- Centerline Clear View padded official's stand sold separately

VB100065 \$3,849⁹⁹ SET

Complete System Without Ground Sleeves

Complete Centerline Aluminum System with 3" aluminum telescoping and winch, Kevlar top rope net, Centerline antennae and pole pads (specify color)

VB100065W0 \$3,499⁹⁹ SET



FREE PAD LETTERING!



ACCESSORIES		
VB125065	Kevlar Top Rope Net	\$449 ⁹⁹ EA
VB50P65	Centerline Pole Padding - Specify Color	\$629 ⁹⁹ PR
1071580	Screen Printing-up to 10 block letters-Per location	\$179 ⁹⁹ EA
VB7365	Centerline Clear View Judges Stand w/ Grey padding only	\$999 ⁹⁹ EA
VB2365	3" Floor sockets with Brass Floor Plates	\$299 ⁹⁹ EA
VB15065	Centerline Antennae	\$199 ⁹⁹ EA



Bid #ESCNJ 17/18-31

Gold Medal

ATHLETIC PRODUCTS

Educational Services Commission of New Jersey

Athletic Equipment & Supplies

VOLLEYBALL

NETS	USES	SIZE/BODY	HEADBAND	BOTTOM	CABLE	PRICE/CODE
	ULTIMATE VOLLEYBALL NET Telescopic Aluminum System AAI Systems	32' x 1m, 3.0mm braided knotted nylon	2" HD white polyester	11/4" HD white polyester side pockets; fiberglass dowels w/ 3 intergrated D-Rings white nylon webbing tension straps	34' Aramid fiber top Nylon rope bottom	\$299 ⁹⁹ EA ★ 1235661
	MASTER VOLLEYBALL NET Senoh & most Power VB systems	32' x 1m, 3.5mm braided knotless HTPP	18 oz coated vinyl top	18 oz vinyl w/ fiberglass dowels, 14 oz coated vinyl bottom	45' Aramid fiber top Nylon rope bottom	\$169 ⁹⁹ EA ★ SNMCMAS2
	PRO POWER VOLLEYBALL NET VX2000 System PPS Steel System	32' x 1m, 3.5mm braided knotless nylon	14 oz laminate vinyl top/bottom	14 oz laminate w/ fiberglass dowels	34' PVC coated steel top cable w/ 3" leader cable includes net tension straps	\$169 ⁹⁹ EA ★ SNINTLVB
	PRO POWER 2 VOLLEYBALL NET Systems w/ Double Ratchets	32' x 3', 2.5 mm polyethylene twisted knotted	2" HD 14 oz vinyl top/bottom	Steel dowels w/ synthetic leather cover 14 oz vinyl	40' L 1/8" thick coated steel top and bottom	\$86 ⁹⁹ EA ★ SNVBSP32Y
	SPORT VOLLEYBALL NET HS Physical Education ST240PWR	32' x 3', 2mm polyethylene twisted knotted	1.5" HD 14 oz vinyl top w/ 1.5" bottom	10 oz vinyl coated tape	40' L 1/8" thick coated steel top w/ vinyl coated tape bottom	\$59 ⁹⁹ EA ★ SNVBSC32Y
	RECREATIONAL VOLLEYBALL NET Jr High Phys Ed ST240S/P ST240C/S	25', 27', 30', 32' x 3' Specify length 2mm polyethylene twisted knotted	1.5" HD 10 oz vinyl top	10 oz vinyl coated tape	1/4" thick rope top	\$39 ⁹⁹ EA ★ SNVBR
	MULTI-COLOR ECONOMY NETS Recreational Play	32' x 3' 2 tone polyethylene 2mm twisted knotted	1.5" HD 10 oz vinyl top	10 oz vinyl coated tape	40' L 5/32" thick polyester rope top	\$31 ⁹⁹ EA ★ 1048612 Yellow/Blk
	ECONOMY VOLLEYBALL NET Elementary Physical Education	32' x 3', 1.75mm polyethylene twisted knotted	1.5" HD 10 oz vinyl top	10 oz vinyl coated tape	40' L 5/32" thick polyester rope top	\$27 ⁹⁹ EA ★ SNVBECO2Y

VB NET STORAGE SYSTEM

Net storage system for 3 nets

1238822	3 Nets	\$249 ⁹⁹ EA ★
1238815	2 Nets	\$299 ⁹⁹ EA ★
1238808	1 Net	\$269 ⁹⁹ EA ★

porter WALL STORAGE RACK

- Secures 2 volleyball poles in place
- Holds pole up to 3.3" diameter

 PR825 \$149⁹⁹ EA

FLOOR MARKING TAPE

- Use on any smooth floor surface

 Color Options:
Black, Blue, Green, Gold, Orange, Purple, Red, White.

FTAP16	1" x 60 Yd.	\$5 ⁹⁹ EA ★
FTAP26	2" x 60 Yd.	\$9 ⁹⁹ EA ★

FLOOR TAPE APPLICATOR
NEW

- Sturdy steel applicator
- Ideal for laying 1" or 2" single sided tape
- Use for straight or curved lines

TAPEMAC \$49⁹⁹ EA ★

NJ State Approved Co-op #65MCESCCPS Metuchen/Garden State AppareBid Term: 5/9/18 - 5/8/20: Extended to 5/8/21



LINESMAN FLAGS

- Set of 4 linesman flags with case
- Deluxe aluminum handles with soft grips
- Flag Size: 12" x 12"

1376640 \$39⁹⁹ SET



OFFICIAL WALLYBALL® GAME KIT

Transform unused racquetball courts into an exciting team action court

- Two teams of up to 4 players per team
 - Rules and skills are similar to volleyball
 - Wallyball® offers more contact than traditional volleyball
- Includes: ball, net, net tightener clamp, storage bag, and hardware and instructions for installation

6500KXXX \$177⁹⁹ CT

COURT HARDWARE

- Includes all hardware to hang one net: anchors, bolts and bushings

6504KXXX \$59⁹⁹ SET



NET CLAMP

- Net tension clamp for lightweight nets with nylon top ropes

6004KXXX \$14⁹⁹ EA



WALL SUCTION CUPS

- Rubber suction cups for net attachment on glass walls

1033670 \$97⁹⁹ EA

WALLYBALL® NET

- Regulation net with black nylon netting with blue and gold trim
- Net tightener included

6502KXXX \$134⁹⁹ EA

OFFICIAL WALLYBALL® BALL

- The official bright blue ball of Wallyball®
- Specially developed velvety and durable synthetic cover

6503KXXX \$18⁹⁹ EA ★



VOLLEYBALL PAL

- Ideal for single player practice serving/tosses or arm swing techniques without chasing the ball
- Consists of adjustable waist strap and a neoprene pouch that holds the ball with elastic connecting cord
- Smooth action of cord guides back to player everytime

1238785 \$29⁹⁹ EA



VOLLEYBALL TARGET CHALLENGER NET

- Adjustable pole height (to 12") and 30" target ring for multi-sport use
- Sturdy net collects balls for easy retrieval
- Includes 22 lb weight for stability and 2 wheels for portability
- Ideal for passing, setting, or shooting
- Pictured with Tandem Colossal Cart

1274424 \$369⁹⁹ EA

COLOSSAL VOLLEYBALL CART

- Nylon basket includes side pockets for storage
- Holds 40 volleyballs
- Black only

1274417 38"H x 42"W x 32"D \$199⁹⁹ EA



SPIKE TRAINER

- Holds the volleyball securely in place while the hitter develops form and hitting technique
- Developed by coaches and is economical, lightweight, and durable
- Perfect for use at camps, clinics, and practices at all levels

98669XX \$149⁹⁹ EA



PASS RITE TRAINING TOOL

- Durable elastic bands prevent excessive upward arm movement
- Attaches to passer's wrists and ankles, designed to minimize ball contact interference
- Adjustable to fit

1238792 \$37⁹⁹ EA



BUNGEE BLOCKER

- The ultimate blocking tool!
- Constructed of lightweight aluminum and bungee straps
- Game-like simulation in practice

1303346 \$99⁹⁹ EA

PRACTICE MAKES PERFECT! SETTING, PASSING, SPIKING... WHATEVER YOU NEED!



VOLLEYBALL TUTOR

- Can automatically feed up to six volleyballs at intervals ranging from six to twenty seconds
 - Propels volleyballs up to 40' at adjustable angles and speeds
 - Compact design and built-in carry handle for easy storage and portability
 - Requires AC power outlet
- Power Source: **AC, Battery.**

MSVTUTOR 37"L x 25"W x 16"H - 25 lbs. \$1,699⁹⁹ EA

Remote Control for Volleyball Tutor

- Foot operated (Cable connected) remote controls the ball feed from as far away as 40'

MSVTREMO Remote Control-Can Not Be Ordered Separately \$119⁹⁹ EA



Bid #ESCNJ 17/18-31

Educational Services Commission of New Jersey

Athletic Equipment & Supplies

VOLLEYBALL



Mizuno®
LR-6 KNEE PAD

- 50% Polyester with 22% Rayon and 28% Elastic.
 - Dynamotion Fit for easy movement
 - 6" sleeve length
 - Low-rise, no-fold design. Complete knee protection.
- Color Options: **Black, White**
Size: **SML, MED, LRG.**

MZ480105 S-L \$26⁹⁹ PR



MacGregor
VOLLEYBALL KNEE PADS

- 9" elastic knee pad with new design for added knee flexibility
 - Soft but protective poly/cotton/spandex for added comfort
- Color Options: **Black, White.**

I310177 Specify Color \$17⁹⁹ PR ★



VORTEX HYBRID SHORT

- Combining the top-rated features of our best-selling Flat Front and Vortex shorts. Lined, flatlock gusset and wide waistband. 92% Polyester with 8% Spandex. Inseam: 3.5".
- Color Options: **Black, Navy**
Size: **XSM, SML, MED, LRG, XLG.**

MZ440561 XS-XL \$23⁹⁹ EA



NET SETTER CHAIN

- Hang from net to measure the correct height of the volleyball net
- 4 pre-set official net heights for Mens, Womens, Co-ed and Junior play

I238778 \$13⁹⁹ EA



Sport Write!
DRY-ERASE BOARDS

- Large format enables entire team to see play
- 2 writing surfaces
- Great pen clip with premium dry erase marker

I383513 12 1/2" H x 16 1/2" W - 2lbs. \$29⁹⁹ EA



VOLLEYBALL SCOREBOOK

- Includes: 24 matches, team roster and simplified instructions.
- NOW INCLUDES RALLY SCORING!!

1111XXXX \$7⁹⁹ EA



VOLLEYBALL CABLE PADDING

- Heavy duty vinyl covered foam padding is split and slips over the top and bottom net cables
- Each pad is 24" long
- Set includes 4 pads

VBCPAD White Only \$58⁹⁹ SET



VOLLEYBALL NET TENSION STRAPS

- 2" velcro net straps that help secure volleyball net to standards
- Set includes 6 straps

VBTNS \$26⁹⁹ SET

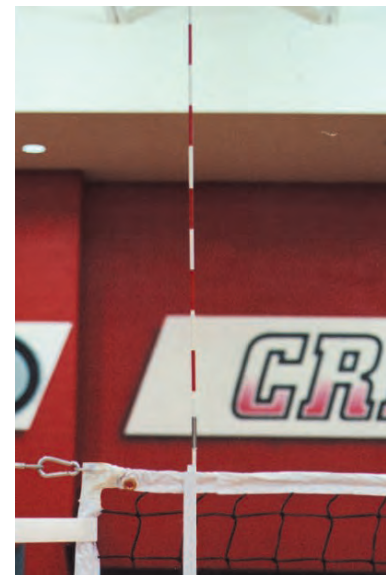

VOLLEYBALL ANTENNA

- White antenna holder is 1" wide complete with velcro strips that secure system to net.
- The antenna slips easily into a pocket for correct

VBANT \$53⁹⁹ PR ★

ALUMAGOAL®

POWER STANDARDS

(FLOOR PLATE REQUIRED)

1. POWER PLAY GAME STANDARD

- 24" heavy wall steel base, with non-marring rubber floor protectors, non-marring wheels, and blue powder coated finish
- 2-3/8" heavy wall galvanized steel uprights with pre-set heights to play men's and women's volleyball, badminton, and tennis
- Includes: 2 safety padded guy wires, 2 floor plate anchors with hand bolts, 2 pulleys and a safety precision worm gear winch
- Designed for competitive play
- Recommended net - SNVBC32Y
- Requires floor anchoring.

ST240PWR 110 lbs. - Pair **\$699⁹⁹** PR ★

2. POWER PLAY CENTER STANDARD

- Use with Power Play Game Standards (ST240PWR) for side by side court play
- Same Specifications as the ST240PWR
- Includes winch

ST240PCS 63 lbs. **\$419⁹⁹** EA ★



WORM GEAR STRAP WINCH

- Powder coated housing with stainless steel cover
- Low profile handle does not require removal
- Tension strap eliminates cable kinking
- Universal bolt pattern, designed to use with Power Play Game Standard

ZWORMGEARX **\$144⁹⁹** EA ★

HEAVYWEIGHT STANDARDS

(RECOMMENDED FOR PE)

3. 24" MULTI-GAME STANDARD

- 24" heavy wall steel base, with non-marring rubber floor protectors, non-marring wheels, and blue powder coated finish
- 2-3/8" heavy wall galvanized steel uprights with pre-set heights to play men's and women's volleyball, badminton, and tennis
- Designed for recreational play
- Recommended net - SNVBC32
- Weighted base does not require floor anchoring

ST240S/P 360 lbs. - Pair **\$799⁹⁹** PR ★

24" MULTI-GAME CENTER STANDARD

- Use with Multi-Game Standards (ST240S/P) for side-by-side court play
- Same specifications as ST240S/P

ST240C/S 180 lbs. **\$479⁹⁹** EA ★

4. 30" MULTI-GAME STANDARD

- Heavy weighted base does not require floor anchor
- 30" heavy wall steel base with non-marring rubber floor protectors, non-marring wheels, and blue powder-coated finish
- Pole is 10' high, made of heavy wall galvanized tubing.

VBBASE30 500 lbs. - Pair **\$999⁹⁹** PR ★

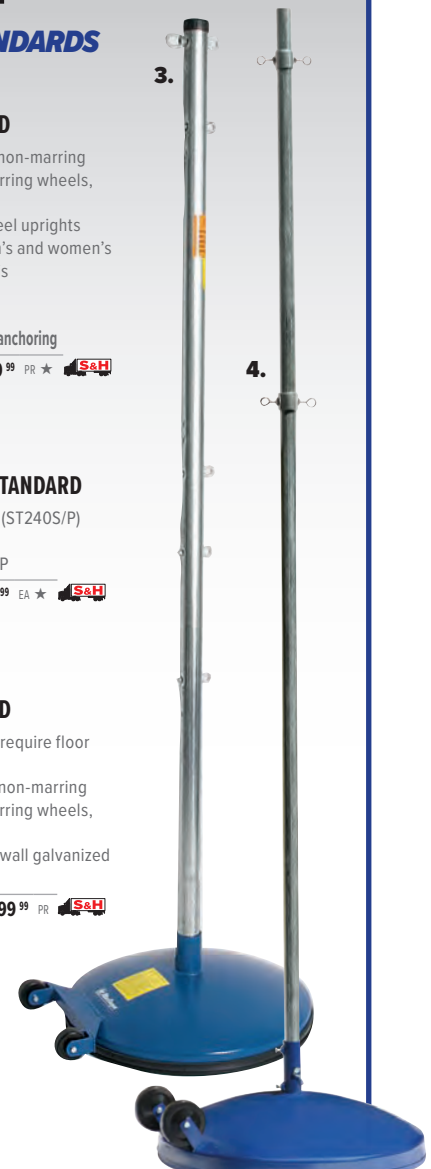

STANDARD POLE PAD

- Fits poles 3" O.D. or smaller
- 6"H with 2" thick vinyl covered foam and hook and loop fasteners
- Not intended for in-ground outdoor volleyball poles

1012415 Royal Blue Only **\$224⁹⁹** PR ★

CENTER POLE PAD

- Pad for the Power Play Game Standard

MSVBPADC Royal Blue Only **\$199⁹⁹** EA



PROTECTIVE BASE PAD

- Vinyl covered bonded foam
- Easy to install with hook-and-loop attachments
- Blue only

1193572 24" Diameter **\$109⁹⁹** EA ★



MULTI-USE STANDARDS

- 24" diameter heavy wall steel base with non-mar rubber rim and 10"H base stem, Pole height: 8'
- 1 3/4" O.D. steel upright with 2 single ring slides for net attachment
- Available in 3 sizes
- Designed for indoor or outdoor use
- Color Options: **Black, Blue, Green, Red, White, Yellow.**

1309294 130 lbs. **\$429⁹⁹** EA

1309355 180 lbs. **\$479⁹⁹** EA

1309416 220 lbs. **\$524⁹⁹** EA

Bid #ESCNJ 17/18-31

Educational Services Commission of New Jersey

Athletic Equipment & Supplies

INDOOR TABLETOP SCOREBOARD

- Dimensions: 16"H x 24"W x 10"D - 13 lbs.
- LED clock digits: 4.75" , LED score digits: 4.25"
- Scores basketball, volleyball and wrestling and can function as a metronome, stopwatch, clock with alarm and program timer
- Included wireless remote (100' range) allows operator to change score and start/stop the clock
- 4 user-programmable frequency settings for operating multiple units independently in the same area
- Includes digital periods, bonus, team fouls and possession indicators
- Indoor use only
- Optional assembled stand measures 43"H x 28"W x 28"D

SK2229R	Indoor Tabletop Scoreboard	\$499 ⁹⁹ EA ★
OPTIONS		
1293784	Wheeled Stand	\$99 ⁹⁹ EA ★
1240597	Extra Loud Horn	\$63 ⁹⁹ EA ★
1142266	Carry Bag	\$74 ⁹⁹ EA ★
1201789	Replacement Remote	\$53 ⁹⁹ EA ★



BUILT IN CONTROL PANEL



MANUAL SCOREKEEPER WITH ADJUSTABLE STAND

- 7" numbers printed on vinyl
- Scores up to 99 for each team
- Two erasable team panels
- PVC stand measures 38"H with a 15" x 15" base
- Converts from floor model to 12"H tabletop unit

1162448 \$51⁹⁹ EA ★



MANUAL TABLETOP DOUBLE SIDED SCOREBOARD

- 6" numbers for scoring
- 2.5" numbers to score games (0-5 for each side)
- Scores up to 30 for each team
- Double-sided, see the score from front and back
- Folds up for easy transport and storage

MSMLTSCR 7"H x 15"W \$58⁹⁹ EA ★

PORTABLE MANUAL SCOREKEEPER

- 6" score digits
- 2.5" Period/Games digit up to 5
- Scores game up to 99 for each side
- No assembly required
- Lays flat for storage

1196177 11"H x 23"W \$49⁹⁹ EA ★



MESH BALL CARRIER

- Comes with shoulder strap, vinyl bottom and mesh top fabric

1235654 22"H x 28"W \$33⁹⁹ EA ★



VOLLEYBALL CARRY BAG

- 9" x 50" black polyester with shoulder strap and strong metal zipper
- Holds 6 volleyballs
- Available in Black or Navy

MSVBA6T \$29⁹⁹ EA ★



E-Z FOLD CART

- Aluminum square frame
- Nylon top with mesh bottom
- Holds 20 basketballs or 30 volleyballs
- Non-marring swivel casters
- Folds to only 6" wide for easy storage



MSVFCM1 \$129⁹⁹ EA ★

OUTDOOR VOLLEYBALL PACKAGES

- 10'H x 2 3/8" O.D. galvanized steel pole inserts 2' into ground sleeves or can be permanently installed in concrete
- Pre-Drilled for volleyball, badminton and tennis
- All weather treated net secures through eye bolts

VBPK1	Steel Top Cable Net - PVC Ground Sleeves/No Cap	\$429 ⁹⁹	SET	★	
VBPK2	Steel Top Cable Net/Steel Ground Sleeves/With Cap	\$544 ⁹⁹	SET	★	
VBPK3	Rope Top Cable Net/PVC Ground Sleeves/No Cap	\$399 ⁹⁹	SET	★	
VBPK4	Rope Top Cable Net/Steel Ground Sleeves/With Cap	\$509 ⁹⁹	SET	★	

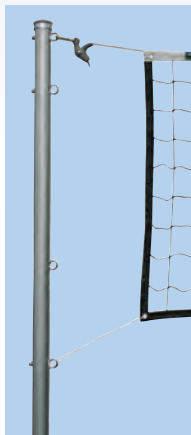

PVC WITH NO CAP



GALVANIZED STEEL WITH WRENCH CAP

ROPE CABLE NET SYSTEM (SHOWN ON LEFT) UTILIZES GALVANIZED STEEL ROPE CLEATS FOR EASY NET ATTACHMENT.



ALL PACKS INCLUDE 6 FREE SOFT SHOT VOLLEYBALLS!

STEEL CABLE NET SYSTEM (SHOWN ON RIGHT) INCLUDES HEAVY DUTY STEEL RATCHET WITH REMOVABLE HANDLE.

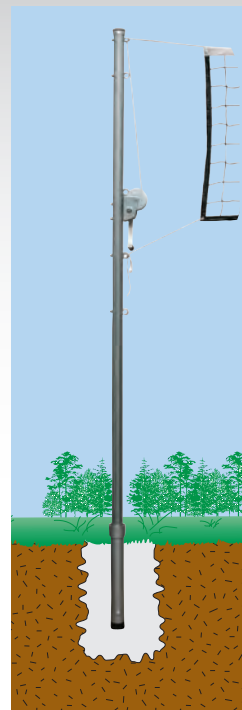

MONGOOSE WIRELESS VOLLEYBALL SYSTEM

Mongoose System is perfect for sand or grass volleyball. Sets up in 5 minutes. The net easily tensions to provide a competition quality play environment. Set includes:

- 2 adjustable high-strength anodized black aluminum posts
- 2 steel in-ground plates
- 2 sand wedge adapters
- 2 blue protective pole pads
- Regulation size net, court boundary line marker, blue nylon carrying bag, and instructions

Lifetime Warranty

1138214	Wireless System	\$469 ⁹⁹	SET
1138221	Indoor Floor Adapter Plates	\$144 ⁹⁹	PR
1138863	Sleeve Adapter	\$164 ⁹⁹	PR



SPECTRUM 2000 VOLLEYBALL SYSTEM

- Quick set up and completely portable
- Aluminum standards have push button locks for easy height adjustment
- Set includes: 1 3/4" telescopic 2-piece aluminum poles, 3' x 32' sleeve net, 1/4" pull-down guyline system, 10" steel stakes, pre-measured boundary w/corner anchors, winder and storage bag

15 Year Limited No State Approved Co-op #65MCESSCPS Metuchen/Garden State Apparel Bid Term: 5/9/18 - 5/8/20: Extended to 5/8/21

60790XXX

\$349⁹⁹ SET



NEW

SPECTRUM 179 VOLLEYBALL SYSTEM

- Excellent mid-range set for all levels of play
- 1 5/8" telescopic, aircraft aluminum poles(3pc)
- Offers height adjustments for men, women, and coed play
- 5/16" double guyline set, 8" steel ground stakes

1399350

\$149⁹⁹ SET

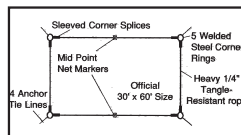

MARK YOUR COURT WHEREVER YOU PLAY!

VOLLEYBALL BOUNDARY MARKERS

- 1/4" heavy-duty polypropylene rope with mid-point net markers, splice protector corner sleeves, nickel-plated corner rings
- Official 30' x 60' court size
- Includes storage winder

90355YLX

Yellow Only

\$61⁹⁹ EA ★



SCHOOL NAMES OR LOGO'S AVAILABLE FOR AN ADDITIONAL CHARGE.



LIGHTWEIGHT WRESTLING MATS

- Constructed of our tough 24oz. non-slip vinyl and premium grade lightweight foam
- Quick and easy setup, breakdown, and storage
- Fast and easy to move, comes in 1 5/8" or 2" thickness
- Antimicrobial-treated vinyl surface
- Exceeds ASTM F1081/F355 impact protection standards
- 5-year limited warranty, ships in 4-6 weeks
- Choose from 9 mat colors: Royal, Navy, Red, Black, Grey, Dk Green, Maroon, Gold, Purple

5 Year Limited Warranty

1393094	36' x 36' x 1 5/8" (6-6' x 36' sections)	\$5,599 ⁹⁹ EA	
1393095	42' x 38' x 1 5/8" (7-6' x 38' sections)	\$6,999 ⁹⁹ EA	
1393096	42' x 40' x 1 5/8" (7-6' x 40' sections)	\$7,299 ⁹⁹ EA	
1393097	42' x 42' x 1 5/8" (7-6' x 42' sections)	\$7,599 ⁹⁹ EA	
1393101	36' x 36' x 2" (6-6' x 36' sections)	\$6,399 ⁹⁹ EA	
1393102	42' x 38' x 2" (7-6' x 38' sections)	\$7,999 ⁹⁹ EA	
1393103	42' x 40' x 2" (7-6' x 40' sections)	\$8,399 ⁹⁹ EA	
1393104	42' x 42' x 2" (7-6' x 42' sections)	\$8,799 ⁹⁹ EA	



LIGHTWEIGHT WRESTLING MAT-SINGLE ROLLS

- Constructed of our tough 24oz. non-slip vinyl and premium grade lightweight foam
- Antimicrobial-treated vinyl surface
- Exceeds ASTM F1081/F355 impact protection standards
- Incredibly fast and easy to set up, breakdown, store and move
- 5-year limited warranty
- Choose from 9 mat colors: Royal, Navy, Red, Black, Grey, Dk Green, Maroon, Gold, Purple

5 Year Limited Warranty

1393245	Single Roll-6' x 36' x 1 5/8"	\$949 ⁹⁹ EA	
1393246	Single Roll-6' x 38' x 1 5/8"	\$999 ⁹⁹ EA	
1393247	Single Roll-6' x 40' x 1 5/8"	\$1,039 ⁹⁹ EA	
1393248	Single Roll-6' x 42' x 1 5/8"	\$1,089 ⁹⁹ EA	





INDOOR TABLETOP SCOREBOARD

- Dimensions: 16"H x 24"W x 10"D - 13 lbs.
- LED clock digits: 4.75", LED score digits: 4.25"
- Scores basketball, volleyball and wrestling and can function as a metronome, stopwatch, clock with alarm and program timer
- Included wireless remote (100' range) allows operator to change score and start/stop the clock
- 4 user-programmable frequency settings for operating multiple units independently in the same area
- Includes digital periods, bonus, team fouls and possession indicators
- Indoor use only
- Optional assembled stand measures 43"H x 28"W x 28"D

SK2229R Indoor Tabletop Scoreboard \$499⁹⁹ EA ★



WRESTLING MAT TRANSPORTER

- Made from 1 3/4" galvanized steel tube with heavy duty casters
- Requires one person to move heavy mats from place-to-place.

6425XXXX 32" x 26" x 11" \$219⁹⁹ EA



BODY FAT/HYDRATION & SCALE

- Measures weight, body fat and water percentage
- 4% - 45% body fat and 37.8% - 66% body water ranges
- 8-person memory
- 330 lbs. maximum capacity
- Adult and child modes
- Requires 9V alkaline battery

1375488 \$52⁹⁹ EA



ANKLE BANDS

Made from soft vinyl that wraps around and fastens with Velcro®. Easy to put on, take off. Washable and will not shrink or stretch out.

1406285 4 bands per set-2-Red/2 Green \$10⁹⁹ EA



MATT-KLEEN® ALL PURPOSE DISINFECTANT CLEANER

- Helps stop the spread of skin diseases and infections
- Ideal for wrestling and gymnastic mats, training tables and shower floors
- Highly concentrated; 2 oz. makes one full gallon

1092479 Gallon \$79⁹⁹ EA



PREDICAMENT WRESTLING SCOREBOOK

- 14" x 10" size with untearable front/back red poly covers
- 48 wrestler stat pages
- Records stats up to 64 matches
- Team tournament and dual meet summary forms

1303629 \$24⁹⁹ EA ★



WRESTLING SCOREBOOK

• Includes NCAA and international wrestling sheets, dual meets, 17 weight classes, tournaments, season summaries, and more.

1420392 \$8⁴⁹ EA



GORILLA GRIP® MAT TAPE

- Specifically designed adhesive that gives powerful grip to your mat
- Leaves no gummy residue
- Reuseable many times, each roll individually wrapped
- 8 mils thick, Color: Transparent

1406240 3" x 84" \$18⁹⁹ ROLL
1406245 4" x 84" \$18⁹⁹ ROLL



MAT TAPE

- Easy to use and remove
- Will not stretch out
- Secures overlaps

6406XXXX 4" x 84" \$15⁹⁹ ROLL ★





TORNADO F5 HEADGEAR

- It's 43% lighter, remarkably cooler and includes a greater audible sound technology.
- Incorporates our Power Tab strapping system for a better, faster fit.
- Combats bacterial build-up.

Color Options: **Black, Dark Green, Maroon, Royal.**

1420147

One Size Fits All

\$39.99 EA



SIGNATURE® E58 HEADGEAR

"Cliff Keen Signature™" 4-strap FOAM headgear. Lightweight, comfortable fit, fully adjustable. Can be adjusted to youth sizes. SP94 chin strap pad included.

Color Options: **Black, Dark Green, Light Gold, Maroon, Navy, Orange, Purple, Royal, Scarlet, Silver Grey, Vegas Gold, White.**

1242508

One Size Fits All

\$37.99 EA



NEW!



FUSION HEADGEAR

- 3-strap design provides for a soft and comfortable fit
- Protective closed cell foam
- Sleek-profiled ear cups, provides enough room and protection for your ears to fit comfortably

Color Options: **Black/Black, Black/Cardinal, Black/Gold, Black/Orange, Black/Scarlet, White/Black, White/Dk Green, White/Maroon, White/Navy, White/Royal, White/Scarlet.**

1399739

One Size Fits All

\$41.99 EA



TORNADO YF5 YOUTH HEADGEAR

- Fits youth head 18-21.5" circumference at the eyebrows
 - Cool, lightweight, and comfortable to wear
- Color Options: **Black/Black/Black, Translucent/Black/Black, Translucent/Royal/Royal, Translucent/Scarlet/Black.**

1395234

Youth Size

\$36.99 EA



IMPACT BK64 KNEE PAD

- Patented ergonomic construction and anatomical compression-molded "bubble" which provides high-impact protection
- Excellent fit and machine washable
- All knee pads sold individually

Color Options: **Black, Navy, Scarlet, White/Charcoal.**

1395249

Adult-One Size Fits Most

\$14.99 EA



WRAPTOR 2.0 KNEE PAD

This sleek knee pad brings added comfort and function with stretch mesh panels on the back, ensuring a comfortable fit and increased performance on the mat. All knee pads are sold individually.

Size: **XSM, SML, MED, LRG, XLG, 2XL.**

1392963

XS-2XL

\$19.99 EA





OLYMPIC STYLE BARS

- All bars are made of high-tensile chrome-molybdenum steel
- All bars have bronze bushings for smooth sleeve rotation and no end screws
- 1101247 features special center knurling, made especially for power lifters
- Weights should always be removed from bar when not in use
- All bars carry a 10 year limited warranty

1. 1101247	86" Zinc Plated - 1500 lb. Capacity	\$279 ⁹⁹ EA ★
2. 1101248	86" Black Oxide - 1500 lb. Capacity	\$299 ⁹⁹ EA ★
3. 1101249	86" Black Zinc with Chrome Sleeves - 1000 lb. Capacity	\$229 ⁹⁹ EA ★
4. CHC0B760	60" Chrome Plated - 700 lb. Capacity	\$169 ⁹⁹ EA ★
5. 1101250	72" Aluminum Technique Bar - 200 lb. Capacity	\$189 ⁹⁹ EA ★
6. CHC0CBXX	Olympic 47" EZ Curl Bar	\$114 ⁹⁹ EA ★
7. CHSNPXXX	Bar Wrap Pad	\$16 ⁹⁹ EA ★

WEIGHT LIFTING CHAINS

- Helps zero-out momentum near lockout for a more effective lift
- Each link provides consistent and accumulated resistance as it's lifted
- Each chain is 60"L with black powder coated bar collars

1326383	1/2" - 22 lb.	\$159 ⁹⁹ PR
1326390	5/8" - 32 lb.	\$179 ⁹⁹ PR
1326406	3/4" - 52 lb.	\$229 ⁹⁹ PR

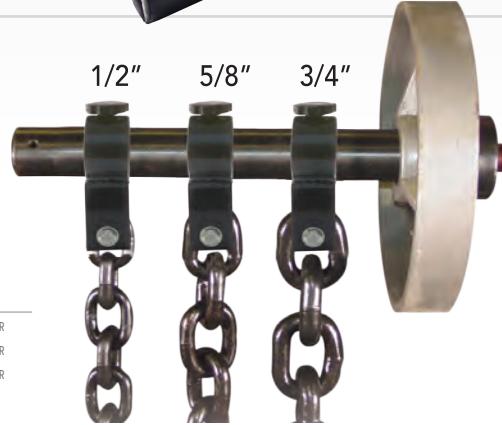

STRENGTH BANDS

PowerMax

- Bands add resistance to lifting exercises without increasing weight, can also be used for assisted pull-ups and dips
- All bands are 41"L and 3/16" thick; width varies with level of resistance
- Made of super strong seamless latex rubber for lasting durability

PMTA17110	XXLight (5-35 lbs.) Red	\$14 ⁹⁹ EA
PMTA17160	X Light (10 - 50 lbs.) Orange	\$27 ⁹⁹ EA
PMTA17170	Light (25 - 80 lbs.) Purple	\$36 ⁹⁹ EA
PMTA17120	Medium (50-120 lbs.) Blue	\$39 ⁹⁹ EA
PMTA17130	Heavy (60-150 lbs.) Green	\$48 ⁹⁹ EA
PMTA17140	XHeavy (70-175 lbs.) Black	\$68 ⁹⁹ EA
PMTA17150	XXHeavy (80-200 lbs.) Yellow	\$84 ⁹⁹ EA



OLYMPIC TRAP/HIP BAR

- Unique design facilitates an optimal power position, placing the load on the hips and alleviating stress on the back
- Dual high/low handle design with 26mm grip diameter
- For use with Olympic-style plates
- 57"L x 25"W x 6"H - 52 lbs.

1395606 \$289⁹⁹ EA



REACTOR

LAND MINE TRAINER

- Made of heavy-duty 11 gauge black powder coated steel
- Perform dynamic movements and exercises simply by inserting any Olympic-size bar (not included) into the 10" pivoting sleeve
- 5" lower tube inserts into any standard Olympic plate to create an anchor/base

1377173 \$84⁹⁹ EA



CHAMPION BARBELL

OLYMPIC-STYLE TRICEP BOMBER

- Constructed of 1" chrome stock
- For use with Olympic-style plates
- Includes wrenchless collars
- Weight plates sold separately

CHTRICOL \$139⁹⁹ EA ★



CHAMPION BARBELL CHROME SPRING COLLAR

- For use with Olympic bars

1015911 \$12⁹⁹ PR ★

LOCK-JAW COLLAR

- Solid nylon injection molded frame and injection molded pads
- Single-action cam lock securely clamps the collar to the bar
- For use with Olympic bars



1379947 Black Only \$38⁹⁹ PR

LOCK-JAW PRO COLLAR

- The larger lever and SPRING LOADED SNAP LATCH ensures easy installation and removal of the collar
- The exceptional clamping force keeps the weights secured
- The PRO is for serious lifters, high-impact workouts, and anytime bumper plates are used on a bar



1395572 Black Only \$42⁹⁹ PR



CHAMPION BARBELL

VERTICAL OLYMPIC BAR HOLDER

- Holds 8 Olympic style bars securely in a minimal amount of space
- Horns have nylon sleeves to protect bars
- 16" diameter x 3/4" solid steel base with black powder coated finish

20028055 42 lbs. \$154⁹⁹ EA ★



CHAMPION BARBELL

WRIST ROLLER

- Improves wrist, forearm and grip strength
- For use with standard (1" hole diameter) or Olympic (2" hole diameter) plates
- Weight plate sold separately

CHCWRXXX \$29⁹⁹ EA ★

Bid #ESCNJ 17/18-31



OLYMPIC GRIP PLATES

• All plates have a durable, grey hammertone, acrylic finish

1272475	2.5 lb.	\$4 ⁹⁹ EA ★	1272512	35 lb.	\$49 ⁹⁹ EA ★
1272482	5 lb.	\$8 ⁹⁹ EA ★	1272529	45 lb.	\$65 ⁹⁹ EA ★
1272499	10 lb.	\$15 ⁹⁹ EA ★	1272536	100 lb.	\$149 ⁹⁹ EA ★ S&H
1272505	25 lb.	\$38 ⁹⁹ EA ★			



RUBBER COATED OLYMPIC GRIP PLATE

• Will not crack, chip, flake, peel, rust or tear like painted cast iron plates
 • Prevents damage to floors, upholstery and will not dent or scratch equipment
 • Reduces weight room noise
 • Set includes: 1000 lb. capacity Olympic bar, 2 each 45 lb, 35 lb, 25 lb, 10 lb, 2.5 lb, 4 each 5 lb rubber coated grip plates and a pair of 2" Muscle Clamps (Black)

1272550	2.5 lb.	\$7 ⁹⁹ EA ★	1272581	25 lb.	\$54 ⁹⁹ EA ★
1272567	5 lb.	\$13 ⁹⁹ EA ★	1272598	35 lb.	\$76 ⁹⁹ EA ★
1272574	10 lb.	\$24 ⁹⁹ EA ★	1272604	45 lb.	\$99 ⁹⁹ EA ★

300 lb. set with 1000 lb. Capacity Bar

1256574	\$789 ⁹⁹ SET ★ S&H
----------------	--

CHAMPION BARBELL. PLATE HOLDERS

OLYMPIC PLATE HOLDER

• 6 post Olympic plate holder with durable textured, silver powder coated finish
 • 3'H x 18"W x 3'D - 32 lbs.



01810000	\$129 ⁹⁹ EA ★
-----------------	--------------------------

OLYMPIC BAR AND PLATE HOLDER

• 6 plate posts with protective end caps
 • 6 bar holders with nylon sleeves to protect bars
 • Silver powder coated finish
 • 44"H x 20"W x 29"L - 55 lbs.



1366837	\$199 ⁹⁹ EA ★
----------------	--------------------------

OLYMPIC VERTICAL PLATE HOLDER

• 6 post Olympic plate holder with protective sleeves and rubber bump stops
 • Durable textured, silver powder coated finish
 • 4'H x 18"W x 18"D - 72 lbs.



1076097	\$179 ⁹⁹ EA ★
----------------	--------------------------



ROLLING BUMPER PLATE STAND

• Rugged casters allow for easy transport
 • Stores up to 10 - 45 lb. bumper plates
 • Removable center post for easy load and unload
 • Laser cut 1/4" steel base

PMWE528



BLACK RUBBER BUMPER PLATES

• Designed to impact the ground without creating damage to the floor
 • 100% virgin rubber with solid steel insert
 • For use with Olympic-style bars
 • Sold in pairs

1388429	10 lb.	\$99 ⁹⁹ PR
1375514	15 lb.	\$119 ⁹⁹ PR
1388430	25 lb.	\$129 ⁹⁹ PR
1388431	35 lb.	\$189 ⁹⁹ PR
1388432	45 lb.	\$229 ⁹⁹ PR



COLORED RUBBER BUMPER PLATES

• Designed to impact the ground without creating damage to the floor
 • 100% virgin rubber with solid steel insert
 • For use with Olympic-style bars
 • Sold in pairs

1375513	10 lb. - Green	\$159 ⁹⁹ PR
1375515	25 lb. - Yellow	\$269 ⁹⁹ PR
1375516	35 lb. - Blue	\$249 ⁹⁹ PR
1375517	45 lb. - Red	\$399 ⁹⁹ PR

OLYMPIC WEIGHT SETS

All sets include:
 • 28.5mm (1.12") diameter grip x 2.2m (86.6") long Olympic bar made to AAU/IWF specifications with 50mm (1.96") diameter sleeves
 • Bronze bushings for smooth sleeve rotation
 • Olympic grip plates with grey hammertone, acrylic finish
 • One pair of chrome spring collars

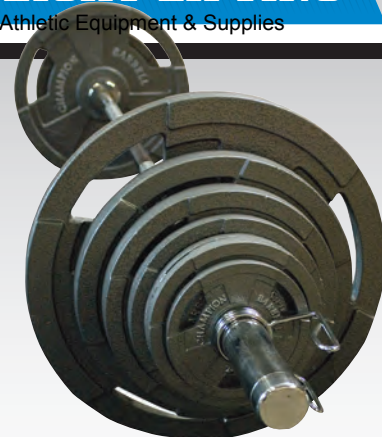

Economy 300 Lb. Weight Set

• Includes 700 lb. capacity chrome bar and spring collars
 • 14 Olympic grip plates - 2/45's, 2/35's, 2/25's, 2/10's, 4/5's, 2/2.5's

1035636	\$469 ⁹⁹ SET ★ S&H
----------------	--

300 LB. Standard Weight Set

• Includes 1000 lb. capacity black zinc bar with chrome sleeves and spring collars
 • 14 Olympic grip plates - 2/45's, 2/35's, 2/25's, 2/10's, 4/5's, 2/2.5's

WSSETS310	\$549 ⁹⁹ SET ★ S&H
------------------	--

300 Lb. Deluxe Weight Set

• Includes 1500 lb. capacity black oxide bar and spring collars
 • 14 Olympic grip plates - 2/45's, 2/35's, 2/25's, 2/10's, 4/5's, 2/2.5's

CHCOS310	\$649 ⁹⁹ SET ★ S&H
-----------------	--

400 Lb. Olympic Set

• Includes 1500 lb. capacity black oxide bar and spring collars
 • 18 Olympic grip plates - 4/45's, 2/35's, 2/25's, 2/10's, 6/5's, 2/2.5's

CHCOS400	\$749 ⁹⁹ SET ★ S&H
-----------------	--

500 Lb. Olympic Weight Set

• Includes 1500 lb. capacity black oxide bar and spring collars
 • 22 Olympic grip plates - 6/45's, 2/35's, 2/25's, 2/10's, 8/5's, 2/2.5's

CHCOS500	\$859 ⁹⁹ SET ★ S&H
-----------------	--

WEIGHT LIFTING



10CM WIDE OFFICIAL WEIGHT BELT

- Two prong buckle
- Natural finish, high quality cowhide
- Lifting belt without taper
- Specify size: S (27-36"), M (31-40"), L (35-44"), XL (39-48"), XXL (43-52")

CHOLB	S-L	\$55 ⁹⁹	EA ★
CHOLBXLX	XL	\$61 ⁹⁹	EA ★
CHOLBXXL	XXL	\$65 ⁹⁹	EA ★



6" WIDE TAPERED TRAINING BELT

- Single prong buckle
- Natural finish, high quality cowhide
- Does not meet competition regulations
- Specify size: S (27-36"), M (31-40"), L (35-44"), XL (39-48"), XXL (43-52")

CHCTB	S-L	\$49 ⁹⁹	EA ★
CHCTBXLX	XL	\$55 ⁹⁹	EA ★
CHCTBXXL	XXL	\$59 ⁹⁹	EA ★

4" WIDE TAPERED REGULATION BELT

- Single prong buckle
- Natural finish, high quality cowhide
- Specify size: S (27-36"), M (31-40"), L (35-44"), XL (39-48"), XXL (43-52")

CHCLB	S-L	\$39 ⁹⁹	EA ★
CHCLBXLX	XL	\$45 ⁹⁹	EA ★
CHCLBXXL	XXL	\$49 ⁹⁹	EA ★



NYLON LIFTING BELT

- Nylon belt with patented One-way Velcro® closure
- Patented downward angle fits the natural shape of your back
- Specify Color: Black, Green, Navy, Red, Royal or Purple
- Specify Size: XS (24"-28"), S (27"-32"), M (31"-36"), L (35"-41"), XL (40"-45"), XXL (44"-50")

CH2004XX	4 3/4"	\$54 ⁹⁹	EA
CH2006XX	6"	\$64 ⁹⁹	EA



NEW!



ULTIMATE WRIST SUPPORTS

- Non-stretch to ensure maximum support
- 1/4" thick and 2 1/2" wide neoprene padding for extreme comfort
- 2" extra wide outside strap for added support
- 2" wide rugged steel buckle for a secure fit
- Black only

1395581	\$22 ⁹⁹	PR
----------------	--------------------	----



WALL-MOUNTED BELT RACK

- All steel wall-mounted unit features five 10" long pegs for storage
- 25" long unit attaches to wall to save space
- Mounting hardware not included

MSWMJRACBM	\$44 ⁹⁹	EA ★
-------------------	--------------------	------



BSN SPORTS

GYM CHALK

- For weight-lifting or gymnastics
- Conveniently wrapped in 2 oz. blocks
- Eight blocks per 1 lb. package

PGE4360X	\$16 ⁹⁹	LB ★
-----------------	--------------------	------



NEW!



PLATINUM LIFTING GLOVES

- Made of durable Amara synthetic leather
- Patented FINS on fingers for easy removal
- Washable non-bleeding material
- Durable non-slip padded palm and thumb with 3/4 finger length

1395598	Specify Size: XS - 2XL	\$34 ⁹⁹	PR
----------------	------------------------	--------------------	----



LIFTING STRAPS

- Removes pressure from hands to allow for greater lifting ability
- High quality 1 1/2" heavy cotton web construction
- One size fits all

1273731	\$10 ⁹⁹	PR
----------------	--------------------	----



SOLID HEX DUMBBELLS

- Solid cast iron with durable, grey hammertone, acrylic finish
- Straight handles with deep set knurling for functional performance
- Now sold as each, not pairs

1152051	3 lb.	\$4 ⁹⁹	EA ★	1152063	60 lb.	\$79 ⁹⁹	EA ★
1152052	5 lb.	\$7 ⁹⁹	EA ★	1152064	65 lb.	\$86 ⁹⁹	EA ★
1152053	10 lb.	\$13 ⁹⁹	EA ★	1152065	70 lb.	\$92 ⁹⁹	EA ★
1152054	15 lb.	\$20 ⁹⁹	EA ★	1152066	75 lb.	\$97 ⁹⁹	EA ★
1152055	20 lb.	\$27 ⁹⁹	EA ★	1152067	80 lb.	\$102 ⁹⁹	EA ★
1152056	25 lb.	\$34 ⁹⁹	EA ★	1152068	85 lb.	\$110 ⁹⁹	EA ★ S&H
1152057	30 lb.	\$41 ⁹⁹	EA ★	1152069	90 lb.	\$118 ⁹⁹	EA ★ S&H
1152058	35 lb.	\$47 ⁹⁹	EA ★	1152070	95 lb.	\$125 ⁹⁹	EA ★ S&H
1152059	40 lb.	\$53 ⁹⁹	EA ★	1152071	100 lb.	\$137 ⁹⁹	EA ★ S&H
1152060	45 lb.	\$60 ⁹⁹	EA ★	1390919	5-50 lb. Set	\$599 ⁹⁹	SET ★ S&H
1152061	50 lb.	\$64 ⁹⁹	EA ★	1390921	55-100 lb. Set	\$1,749 ⁹⁹	SET ★ S&H
1152062	55 lb.	\$71 ⁹⁹	EA ★				



RUBBER ENCASED SOLID HEX DUMBBELLS

- Permanently attached cast iron heads are encased in maintenance free virgin rubber
- Ergonomically designed solid steel handle for comfort and safety
- Handles are knurled and chrome plated; will not peel or chip

1347753	3 lb.	\$11 ⁹⁹	EA ★	1347883	60 lb.	\$110 ⁹⁹	EA ★
1347760	5 lb.	\$15 ⁹⁹	EA ★	1347890	65 lb.	\$115 ⁹⁹	EA ★
1347777	10 lb.	\$24 ⁹⁹	EA ★	1347906	70 lb.	\$130 ⁹⁹	EA ★
1347784	15 lb.	\$32 ⁹⁹	EA ★	1347913	75 lb.	\$135 ⁹⁹	EA ★
1347791	20 lb.	\$39 ⁹⁹	EA ★	1347920	80 lb.	\$145 ⁹⁹	EA ★
1347807	25 lb.	\$46 ⁹⁹	EA ★	1347937	85 lb.	\$155 ⁹⁹	EA ★ S&H
1347814	30 lb.	\$52 ⁹⁹	EA ★	1347944	90 lb.	\$165 ⁹⁹	EA ★ S&H
1347821	35 lb.	\$63 ⁹⁹	EA ★	1347951	95 lb.	\$170 ⁹⁹	EA ★ S&H
1347838	40 lb.	\$75 ⁹⁹	EA ★	1347968	100 lb.	\$180 ⁹⁹	EA ★ S&H
1347845	45 lb.	\$78 ⁹⁹	EA ★	1390922	5-50 lb. Set	\$799 ⁹⁹	SET ★ S&H
1347869	50 lb.	\$90 ⁹⁹	EA ★	1390920	55-100 lb. Set	\$1,949 ⁹⁹	SET ★ S&H
1347876	55 lb.	\$100 ⁹⁹	EA ★				

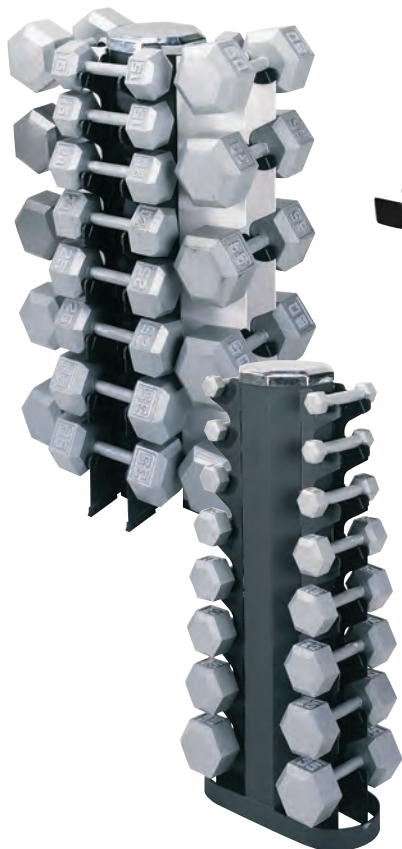

CHAMPION BARBELL UPRIGHT DUMBBELL STORAGE RACKS

- Space saving design with maximum storage capacity
- Accommodates most styles of dumbbells
- 42" High with 9" X 19" base
- Dumbbells not included

1137563	4-Sided - Holds 13 Pair	\$289 ⁹⁹	EA ★
1137574			



CHAMPION BARBELL ADJUSTABLE DUMBBELL RACKS

- Cradle width is adjustable during assembly to accommodate an inside handle length between 4 1/2" and 5 3/8"
- Cradles are black UHMW polyethylene
- 2" x 3" 11-gauge steel frame construction with silver powder coated finish
- Dumbbells not included



POWER SYSTEMS DELUXE VINYL DUMBBELLS

- Cast iron core coated with durable, thick, easy to clean vinyl
- Will not damage gym floors
- Multiple colors, perfect for gym, classroom and home use
- Set includes rack and 44 pairs of dumbbells: 10 - 1lb, 14 - 2lb, 20 - 3lb, 16 - 5lb, 14 - 8lb, 14 - 10lb.

1395582	1 lb. - Pink	\$2 ⁹⁹	EA
1395583	2 lb. - Yellow	\$3 ⁹⁹	EA
1395584	3 lb. - Purple	\$4 ⁹⁹	EA
1395585	4 lb. - Light Yellow	\$5 ⁹⁹	EA
1395586	5 lb. - Green	\$8 ⁹⁹	EA
1395587	6 lb. - Blue	\$9 ⁹⁹	EA
1395588	7 lb. - Orange	\$10 ⁹⁹	EA
1395589	8 lb. - Dark Blue	\$11 ⁹⁹	EA
1395590	9 lb. - Gray	\$12 ⁹⁹	EA
1395591	10 lb. - Black	\$14 ⁹⁹	EA
1395592	12 lb. - Aqua	\$18 ⁹⁹	EA
1395593	15 lb. - Red	\$21 ⁹⁹	EA
1395602	Rack with Casters Only	\$399 ⁹⁹	EA S&H



WHEELED ADJUSTABLE WEIGHT BENCH

- 7 adjustments from 10 degrees decline to 80 degrees incline
- 5 seat height adjustments
- Constructed of 2" x 3" heavy wall steel tubing
- Pads are 2.5" high density foam with Black marine grade vinyl
- 20"H x 23"W x 54"D - 100 lbs.

815102 No Spotter's Platform
813702 With Spotter's Platform

\$499⁹⁹ EA ★ S&H
\$549⁹⁹ EA ★ S&H



MULTI-BENCH

- Adjusts to decline, flat or incline positions
- Constructed of 2" x 3" heavy wall steel tubing
- Pads constructed of 2.5" high density foam with Black marine grade vinyl
- Padded leg support for added stability
- 20.5"H x 26"W x 62.5"D - 68 lbs.

601102 \$299⁹⁹ EA ★ S&H



ADJUSTABLE CURL BENCH

- Constructed of 2" x 3" heavy wall steel tubing
- Fully adjustable arm pad to accommodate different sized users
- Pads are 2.5" high density foam covered in Black marine grade vinyl
- 32.5"H x 28"W x 41"D - 63 lbs.

600200 \$259⁹⁹ EA ★



FLAT BENCH

- Great for dumbbell flies, rows, pullovers and tricep extensions
- Constructed of 2" x 3" heavy wall steel tubing
- Pads are 2.5" high density foam with Black marine grade vinyl
- Includes wheels for mobility
- 19.5"H x 21"W x 51.5"D - 50 lbs.

600902 \$199⁹⁹ EA ★



ADJUSTABLE INCLINE BENCH WITH SPOTTERS PLATFORM

- Constructed of 2" square heavy wall steel tubing
- Ideal for developing deltoids and upper pectorals
- Pad is 10"W x 42"L and adjusts from 36° to 56° and is constructed of 2.5" high density foam with 40 oz. Black marine grade vinyl
- Includes spotter's platform
- 45"H x 48"W x 48"D - 100 lbs.

812702 \$499⁹⁹ EA ★ S&H



FIELD HOUSE COMPETITION BENCH

- Constructed of 3" x 3" and 2" x 3" heavy wall steel tubing for maximum stability with heavy weights
- Pad is constructed of 2.5" high-density foam with 40 oz. Black marine grade vinyl
- Equipped with lower safety bar rests

814402 \$449⁹⁹ EA ★ S&H



STANDARD BENCH PRESS

- Constructed of 1.5" square heavy wall steel tubing
- Pad is constructed of 2.5" high density foam covered in 40 oz. Black marine grade vinyl
- Equipped with lower safety bar rests

814002 \$299⁹⁹ EA ★ S&H



J-Hook Bar Catch



Resistance Band Attachments

POWER RACKS

- Constructed of 3" x 3" and 2" x 3" heavy wall silver powder coated steel tubing
- 10 weight storage horns with protective wear sleeves and rubber bump stops
- Easily adjustable J-Hook bar catches and safeties with UHMW polyethylene bar guards
- Includes a multi-grip pull up bar and multiple resistance band attachments
- Double Half Rack includes 2 bar storage holders
- Full Power Rack: 96"H x 48"W x 80"D - 460 lbs.
- Double Half Rack: 96"H x 48"W x 91"D - 606 lbs.
- Half Rack: 96"H x 48"W x 57"D - 368 lbs.
- Power lift platform is 8' x 8' with a steel frame and 3/4" rubber top
- A 1 1/2" plywood sub floor consisting of 4 sheets of 3/4" plywood provides a solid non-skid, noise absorbing surface (Plywood is not included with the platform.)
- Weight bars, weight plates and accessories sold separately.

FULL POWER RACK

813900

\$1,499⁹⁹ EA ★



Bar Storage Sleeve



J-Hook Bar Catch



Resistance Band Attachments

HALF POWER RACK

813800

816500

817100

Half Rack and Platform

Half Rack Only - Full Mount

Power Lift Platform Only

\$1,699⁹⁹ EA ★

\$1,199⁹⁹ EA ★

\$649⁹⁹ EA ★



SMITH MACHINE

- Constructed of 2" X 3" heavy wall steel tubing
- 7'L - 700 lb capacity bar rotates on precision roller bearings
- Bar uses precision linear bearings to glide friction free on 1" solid case hardened rods
- Solid steel peg and hook safety catch system with separate adjustable safety stops spaced every 7 inches
- Includes 8 weight storage horns
- 84"H x 71.5"W x 68"D - 310 lbs.

815802

\$1,899⁹⁹ EA ★



THUNDER THRUSTER

- Constructed of 2" x 3" heavy wall tubing
- A must for explosive strength and power training
- Uni-lateral motion allows for equal strength development
- Independent arms are equipped with rubber bump stops for quiet operation
- Precision flange bearings for frictionless smooth motion
- Includes 4 weight storage horns with protective sleeves and rubber bump stops
- 83"H x 50"W x 67"D - 360 lbs.

814300

\$1,049⁹⁹ EA ★



POWER RACK

- Constructed of 2" x 3" heavy wall steel tubing
- Adjustable 1" solid rod safety bars
- Includes pull up bar
- 24" Lifting area between uprights
- 92"H x 48"W x 42"D - 245 lbs.

810900

\$599⁹⁹ EA ★



STEP SQUAT RACK

- Heavy-duty rack offers safety while doing quarter, half or full squats
- Constructed of 2" square heavy wall steel tubing
- Lowest tier is 28" increasing incrementally to the top tier at 60"
- Includes four weight storage horns
- 60"H x 48"W x 65"D - 165 lbs.

816300

\$549⁹⁹ EA ★



FIELD HOUSE LEG PRESS

- Constructed of 2" x 3" heavy wall steel tubing
- Pads are constructed of 2.5" high density foam with Black marine grade vinyl
- Delivers a full range of motion with smooth precision pillow block bearings
- Heavy duty rubber bump stops for quiet operation
- Includes 2 weight storage horns with protective sleeves
- 1200 lb. weight capacity
- 59"H x 32"W x 84"L - 480 lbs.

POWER RAM SLED HACK-MACHINE/LEG PRESS

- This three-way ram sled develops all muscle groups from the lower back and down, including hips, thighs and calves
- 4 start-stop locations to accommodate various height users
- The 85 lb. carriage glides smoothly at a 45 degree angle on 4 precision linear bearings
- Constructed of 2" x 3" heavy wall steel tubing
- Pads are constructed of 2.5" high density foam with Black marine grade vinyl
- Adjustable backrest/footrest to ensure proper angle for exercises
- Equipped with safety catches that can be engaged by user from any position
- 51"H x 32.5"W x 90"D - 400 lbs.

814202

\$1,599⁹⁹ EA ★

816702

\$1,799⁹⁹ EA ★



GLUTE/HAM MACHINE

- Constructed of 2" x 3" heavy wall steel tubing
- Pads are constructed of 2.5" high density foam with Black marine grade vinyl
- Strengthens lower back, hamstrings and core
- Foot pads adjust vertically and horizontally to fit all size users
- Equipped with knee pads to aid with mounting and dismounting
- Includes rear handle used for reverse hyper extensions
- 42"H x 34"W

LEG EXTENSION/CURL MACHINE

- Constructed of 2" heavy wall steel tubing
- Pads are constructed of 2.5" high density foam with Black marine grade vinyl
- Ideal for complete leg conditioning and strengthening of knee, thighs and hamstrings
- Features special split pad that allows for the proper isolation of the muscles
- Can be used for leg extension exercises in the sit-up position and leg curls in the prone position

814102

\$599⁹⁹ EA ★

813102

\$499⁹⁹ EA ★

Bid #ESCNJ 17/18-31

Educational Services Commission of New Jersey

Athletic Equipment & Supplies



PLATE LOADED NECK MACHINE

- Constructed of 2" heavy wall steel tubing
- 4 way machine (front/back, left/right) works all the neck muscles
- Arm pivots on precision flange bearings to provide smooth action
- Removable pin is used to restrict direction of head movement
- Fully adjustable seat height
- Includes 2 weight storage horns
- 56"H x 26"W x 48"D - 110 lbs.

813602

\$379⁹⁹ EA ★ **S&H**



PLATE LOADED INCLINE ROWER

- Constructed of 2" square heavy wall steel tubing
- Olympic plate loaded rower designed to develop the rhomboids, trapezius, anterior deltoids and biceps
- Comfortable chest pad covered with durable Black marine grade vinyl
- Swivel handle bar for proper support and angle while doing heavy lifting and strength training
- 48"H x 27"W x 80"L - 135 lbs.

813002

\$399⁹⁹ EA ★ **S&H**



PLATE-LOADED LAT PULLDOWN/LOW ROW COMBO

- Constructed of 2" square heavy wall steel tubing
- Includes rowing attachment, 20" bar and 48" lat bar
- Equipped with height adjustable seat and knee rollers
- Pad is constructed of 2.5" high-density foam with 40 oz. Black marine grade vinyl
- 86"H x 30"W x 65"L - 185 lbs.

814902

NJ State Approved Co-op #551 CESCPCS Metuchen/Garden State Apparel Bid Term: 5/9/18 - 5/8/20: Extended to 5/8/21



CABLE ATTACHMENTS

1. CHLBPROX	30" Pro-Style Lat Bar	\$39 ⁹⁹ EA ★	6. CHLBTRXX	Nylon Tricep Rope	\$29 ⁹⁹ EA ★
2. CHLB481X	48" x 1" Lat Bar	\$49 ⁹⁹ EA ★	7. CHLBVPRS	V Shaped Press Down Bar	\$19 ⁹⁹ EA ★
3. CHLBHNDL	Single Chrome Handle	\$12 ⁹⁹ EA ★	8. CHLBMLTI	Revolving Multi-Exercise Bar	\$34 ⁹⁹ EA ★
4. CHLBV20X	Multi Purpose V-Bar	\$29 ⁹⁹ EA ★	9. 1101256	Ab Crunch Strap	\$39 ⁹⁹ EA ★
5. CHLB20RT	20" Rotating Straight Bar	\$25 ⁹⁹ EA ★	10. 1101263	Nylon Ankle Strap	\$18 ⁹⁹ EA ★

11. **1382829**

Deluxe Cable Attachment Package (1 each of all of the above)

\$249⁹⁹ SET ★

SAVE 15%
NOW \$59⁹⁹

CABLE ATTACHMENT PACKAGE

PACKAGE INCLUDES 1 OF EACH

- 20" rotating straight bar
- Tricep lat rope
- "V" shaped press down bar

1051377

\$59⁹⁹ pack ★





CHIN & DIP STATION

- Constructed of 2" square heavy wall steel tubing
- Multi-grip pull up bar combined with heavy duty dip bar supports with built in step ups
- All welded end caps with tabs for bolting to floor
- 90"H x 26"W x 64"D - 150 lbs.

814800 \$389⁹⁹ EA ★



AB EXERCISER, DIP & SIT UP BOARD COMBO

- Constructed of 2" square heavy wall steel tubing
- Use for bent knee raises, straight leg lifts or dips
- Built with 75 degree angle to target abdominal muscles
- Pads are 2.5" high density foam with 40 oz. Black marine grade vinyl
- All welded end caps with tabs for bolting to floor
- 67"H x 25"W x 64"D

814502 Ab/Dip Only \$389⁹⁹ EA ★
814602 Combo \$649⁹⁹ EA ★

BACK & ABDOMINAL EXERCISE BENCH

- Constructed of 2" square heavy wall steel tubing
- Combines hyper extension and Roman chair exercises for the abdomen and lower back
- Adjustable design to accommodate user height
- Pads are 2.5" high density foam with 40 oz. Black marine grade vinyl
- 29.5"H x 36"W x 49.5"D - 93 lbs.

816502 \$349⁹⁹ EA ★



ADJUSTABLE SIT UP BOARD

- Constructed of 2" x 3" heavy wall steel tubing
- 6 spring loaded pin positions from 0° - 30° incline
- 16"W x 44"L board is 2.5" high density foam with 40 oz. Black marine grade vinyl
- Ankle and knee supports are fully padded for comfort
- 45"H x 22.5"W x 66.5"L - 63 lbs.

813302 \$279⁹⁹ EA ★



CHIN/DIP/AB STATION

- Constructed of 2" square heavy wall steel tubing
- Multi-grip pull up bar on one side and dip bar and knee raise grips on the other side allows two athletes to exercise simultaneously
- Pads are constructed of 2.5" high-density foam with 40 oz. Black marine grade vinyl
- All welded end caps with tabs for bolting to floor
- 90"H x 26"W x 64"D - 180 lbs.

814702 \$499⁹⁹ EA ★

HEAVY DUTY LEATHER DIP BELT

- Constructed of heavy-duty leather and steel chain
- Belt is 29"L and chain is 24"L
- Weight plate not included

CHDBXXXX \$59⁹⁹ EA ★





MULTIFIT SYSTEM

- Perform 11 different exercises in 7 workout stations
- Constructed of 2" square heavy wall steel tubing with a silver powder coated finish (lifetime warranty on welds)
- Built in steps for Chin, Dip & Knee Raise
- Pads are 2.5" high density foam with 40 oz. Black marine grade vinyl

815002 \$1,399⁹⁹ EA ★



THE ULTIMATE WORKOUT SYSTEM!

VARIABLE CONFIGURATIONS TO FIT YOUR SPACE

EXERCISE AREA: 11' L X 5'7" D X 7'6" H WEIGHT: 300LBS



SIT UPS



DIP STATION



LAT/PULL UP



ABDOMINAL KNEE RAISES



45° BACK EXTENSION



PUSH UPS



PLYO BOX JUMPS



SQUATS



CABLE CROSSOVER MACHINE

- Used for chest pulls, press downs, lateral raises, curls, leg kick exercises and pull ups
- Fully adjustable pulley blocks
- Includes (2) 150 lb. weight stacks, ankle straps and handles
- 84"H x 144"W x 41"D - 603 lbs.

811302 \$2,299⁹⁹ EA ★



FRAME & VINYL COLOR OPTOINS



SPECIFY FRAME & VINYL COLOR WHEN ORDERING



WEIGHT LIFTING

ALLOW 6-8 WEEKS FOR DELIVERY.



LEG CURL



LEG EXTENSION



LAT PULL DOWN



LOW ROW



CHEST PRESS



INCLINE PRESS



ARM CURL



TRICEP PRESS DOWN

SELECTORIZED MULTI-STATION

- Frame constructed of 2" x 2" and 2" x 3" 11-gauge high-grade powder coated steel
- Pads constructed of 100% Naugahyde and premium density polyethylene foam, that is sewn and top-stitched
- Each 200 lb. weight stack glides smoothly on 2 - 1" solid case hardened steel rods
- Cables are 3/16" aviation grade stainless steel coated in black nylon to 1/4" thickness
- The 4 basic stations include (1) Combo lat pull down/low row (2) Combo tricep extension/bicep curl and upright row (3) Combo leg extension/curl (4) Combo bench/shoulder/incline press
- Requires an area of 14'W x 14'L x 8.6'H
- CAUTION: Before ordering, determine that your floor is strong enough to support the 1,500 lb. weight of the assembled unit

NJ State Approved Co-op #65MCESCCPS Metuchen/Garden State Apparatus Term: 5/9/18 - 5/8/20: Extended to 5/8/21

SAVE 15%
NOW \$59⁹⁹



CHAMPION BARBELL® CABLE ATTACHMENT PACKAGE

SEE CABLE ATTACHMENTS ON PAGE 242.

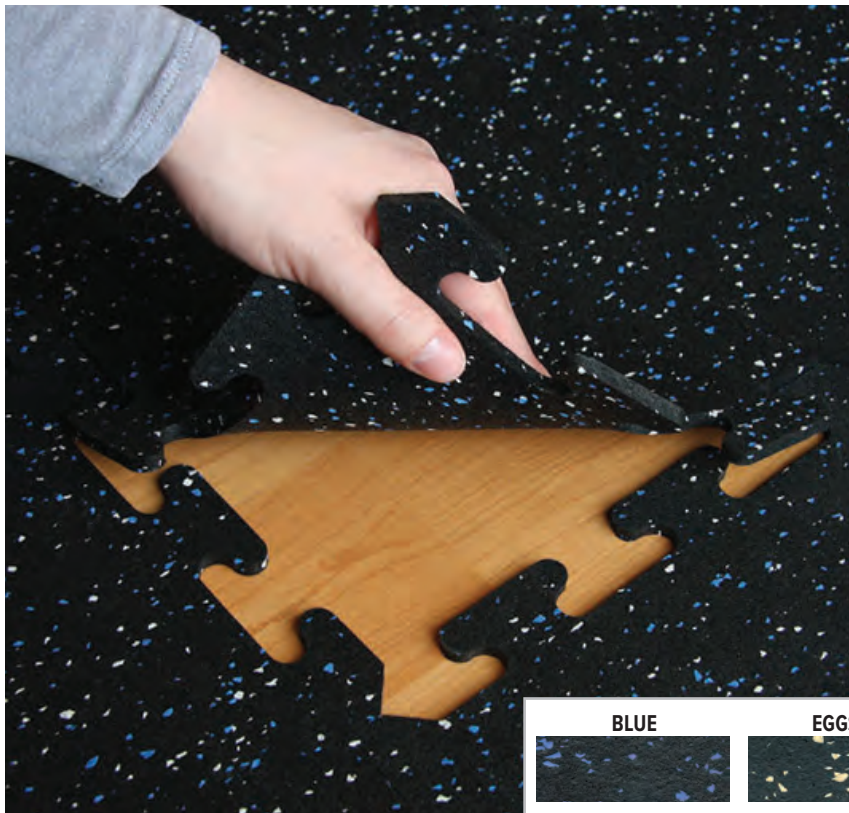

INTERLOCKING TILES - 24"

- Flexible & durable recycled material
- Slip & impact resistant for maximum protection
- No adhesive required
- 9MM (3/8")
- Minimum order 50 pieces

1369628 Specify Color \$20⁹⁹ EA

INTERLOCKING TILES - 36"

- Flexible & durable recycled material
- Slip & impact resistant for maximum protection
- No adhesive required
- 9MM (3/8")
- Minimum order 25 pieces

1369632 Specify Color \$50⁹⁹ EA

INTERLOCKING TILES - 48"

- Flexible & durable recycled material
- Slip & impact resistant for maximum protection
- No adhesive required
- 9MM (3/8")
- Minimum order 25 pieces

1369636 Specify Color \$80⁹⁹ EA

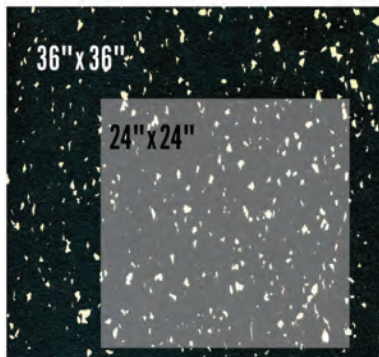
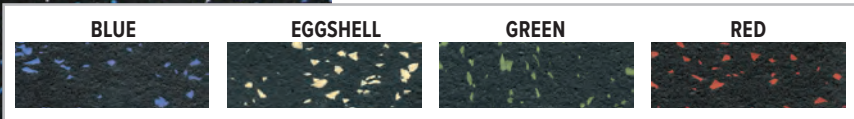

SQUARETILES - 24"

Easy to install. Flexible and durable recycled material. 9MM (3/8 in.). Minimum order 50 pieces.

1369640 Specify Color \$20⁹⁹ EA

SQUARETILES - 36"

- Easy to install
- Flexible & durable recycled material
- 9MM (3/8")
- Minimum order 25 pieces

1369644 Specify Color \$50⁹⁹ EA

INTERLOCKING TILES

- Impact-resistant
- Excellent shock and sound absorbing properties
- Works great for demanding athletic and institutional applications
- 24" x 24" x 8MM (5/16")
- 4 tiles per box/set
- Minimum order 10 boxes

1369649 Black \$80⁹⁹ SET

ROLLED FLOORING

- Made with recycled materials
- Easy installation with fewer seams
- Ideal for use in demanding athletic, commercial, industrial and institutional applications
- 4'W x 25'L x 9MM (3/8") roll
- Adhesive required
- Minimum order 2 rolls

1369648 Black \$339⁹⁹ EA



ZIP-TILE INTERLOCKING FLOORING

- Interlocking 3/8" thick tiles are easy to handle and install
- Tiles are 28.5" x 28.5" with no corner or edge pieces required; simply cut tiles to fit any room
- Unique tab design holds the tiles together, eliminating the need for adhesives or tape
- Easy to clean and maintain
- Made in the USA out of 88% recycled rubber content

2 Year Limited Warranty

1300154 Black \$20⁹⁹ EA
1300161 Specify Flec Color \$25⁹⁹ EA

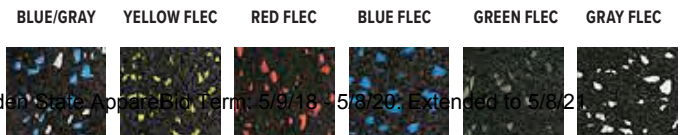



ULTIMATE RB
AN ACCELLA COMPANY
ATHLETIC FLOORING MATS

- A cost effective alternative to other types of expensive flooring
- Protect floor from damage caused by the impact from dropping barbells
- Has cushioning features that protect free weight area floors from dings, scuffs, and other damage
- Available in 1/2" and 3/4" thicknesses and in 3'W x 4'L or 4'W x 6'L sizes
- Uses environmentally friendly recycling technologies; manufactured completely in the USA
- Black only

CHMAT1/2	3'W x 4'L x 1/2"	\$46 ⁹⁹ EA	
CHMAT3/4	3'W x 4'L x 3/4"	\$55 ⁹⁹ EA	
CHMTF1/2	4'W x 6'L x 1/2"	\$93 ⁹⁹ EA	S&H
CHMTF3/4	4'W x 6'L x 3/4"	\$99 ⁹⁹ EA	S&H

FLOORING/MAT CLEANER

- Highly concentrated, phosphate-free formula designed to work with all of RB Rubber flooring systems
- Provides an economical, effective cleaning and deodorizing system for rubber, urethane and other inanimate hard surfaces and synthetic floors in areas that are normally hard to keep fresh smelling such as gyms, schools, clubs and indoor recreation facilities

20015536	\$39 ⁹⁹ GAL
----------	------------------------



CX-941 POLYURETHANE ADHESIVE FOR ROLLOUT RUBBER FLOORING

- CX-941 is a polyurethane-based, structural, trowel grade industrial adhesive
- Elastomer properties enable it to move with rubber as it expands and contracts
- Patented formula is VOC compliant, non-flammable, and contains no solvents or water
- Formulated for indoor and outdoor applications on concrete, asphalt, rubber, cork, plywood, particle or chip board, cement, gypsum and over radiant heat flooring
- Will fully bond in just over two hours
- Provides 60-65 square feet of coverage per gallon



1008319	2 Gallon Pail	\$169 ⁹⁹ EA	
1008326	5 Gallon Pail	\$369 ⁹⁹ EA	

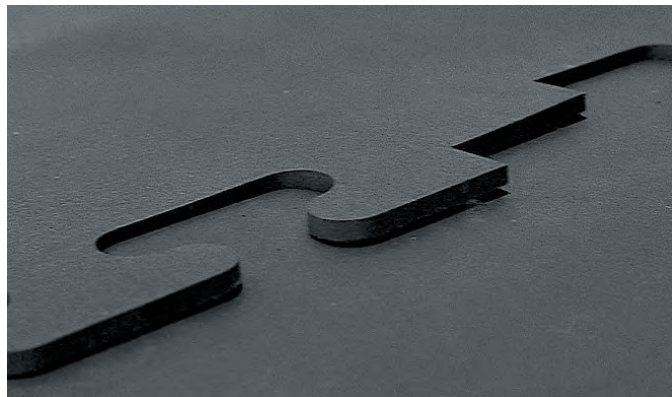

BLUE/GRAY YELLOW FLEC RED FLEC BLUE FLEC GREEN FLEC GRAY FLEC

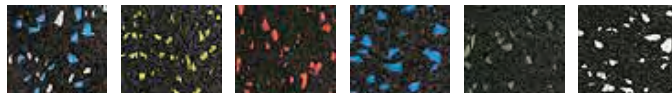

ULTIMATE RB
AN ACCELLA COMPANY

MEGA-LOCK & FLEC-LOCK INTERLOCKING WEIGHT ROOM FLOORING

- Pieces are 30" x 30" x 1/2" thick
- Precision cut, seamless appearance, interlocking mat that is large enough to not require adhesive, but still small enough to be manageable
- Constructed of premium recycled rubber and/or colored EPDM rubber pieces
- Highly resilient, anti-fatigue qualities found naturally in rubber are enhanced by a space age polymer binder used during manufacturing
- Flec-Lock mats contain 10% EPDM color flecs

20015530	Mega-Lock Black - Center	\$30 ⁹⁹ EA
20015532	Mega-Lock Black - Edge	\$30 ⁹⁹ EA
20015531	Mega-Lock Black - Corner	\$30 ⁹⁹ EA
20015533	Flec-Lock Colors - Center	\$32 ⁹⁹ EA
20015535	Flec-Lock Colors - Edge	\$32 ⁹⁹ EA
20015534	Flec-Lock Colors - Corner	\$32 ⁹⁹ EA



NOW AVAILABLE IN FLEC COLORS!

BLUE/GRAY YELLOW FLEC RED FLEC BLUE FLEC GREEN FLEC GRAY FLEC

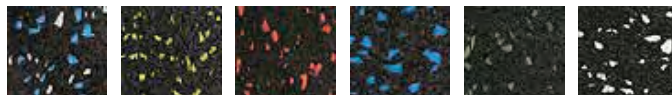

ULTIMATE RB
AN ACCELLA COMPANY

SPORT ROLL FLOORING

- 100% recycled rubber rolls specially designed and manufactured for durability
- Serve as an effective buffer against acoustical vibration
- Suitable for both interior, exterior applications - ideal for surfacing areas that require resilience, sound absorption, spike resistance and traction
- Rolls are 3/8" thick and 4' wide and available in 25', 50' and 75' lengths
- Flec rolls contain 17% EPDM color flecs
- Adhesives are necessary for rolled flooring; Failure to use recommended adhesives may void warranty

1008500	4'W x 25'L x 3/8" - Black	\$289 ⁹⁹ EA	S&H
1377217	4'W x 25'L x 3/8" - Specify Color	\$359 ⁹⁹ EA	S&H
1008388	4'W x 50'L x 3/8" - Black	\$579 ⁹⁹ EA	S&H
1379866	4'W x 50'L x 3/8" - Specify Color	\$699 ⁹⁹ EA	S&H
1379873	4'W x 75'L x 3/8" - Specify Color	\$1,049 ⁹⁹ EA	S&H

Bid #ESCNJ 17/18-31

Educational Services Commission of New Jersey

Athletic Equipment & Supplies



XT685 LIGHT COMMERCIAL TREADMILL

- Requires 110 volt power supply
- Includes: 9" blue backlit LCD, Heart Rate % profile, Muscle Activation Profile, Integrated Speakers with Audio Jack, Swivel Fan, Water Bottle or Cargo Compartment and an Integrated Reading Rack
- 10 operation modes: Manual, Hill, Fat Burn, Cardio, Strength, Interval, Fusion, Calorie, 2 Heart Rate, 2 User
- Contact and telemetric heart rate monitor (wireless chest strap included)
- 0 - 15% grade incline and 0.5 - 12 mph speed
- 3.75 hp DC drive motor
- 56" H x 32" W x 78" L - 273 lbs.
- 425 lbs. maximum user weight

5 Year Limited Warranty

1388453

\$2,299⁹⁹ EA



CT1 FULL COMMERCIAL TREADMILL

- Requires 220 volt power supply
- Leeson Vector drive 5 hp motor
- Speed: 0.5 to 12 mph
- Run belt: 22" x 62" with 3" Rollers
- 7 programmed workout settings: constant load, weight loss, interval, CV workout, Heart rate control, Fat burn, Rolling hills, each has 8 class selections that alter total resistance and can be graphically seen in the "Workout Profile display" plus 1 manual program
- Workout data: time, heart rate, watts, distance, speed, rpm, METS, workout level, calories
- Heart rate: contact grips and wireless
- 60" H x 35" W x 82" L - 385 lbs.
- 450 lbs. maximum user weight

3 Year Limited Warranty

1270938

\$6,499⁹⁹ EA



CRW800 ROWER

- Requires 120 volt power supply
- 5.5" Blue Backlit LCD with adjustable console angle and arm to accommodate different users
- Quickly adjusts between 16 air and magnetic resistance levels without removing your hands from the handle bar
- Padded ergonomic handle with wireless remote resistance control with low battery indicator
- Commercial grade handle strap is smooth and quiet
- 38" H x 18" W x 94" L - 96 lbs.
- 450 lbs. maximum user weight

5 Year Limited Warranty

1390989



\$1,299⁹⁹ EA

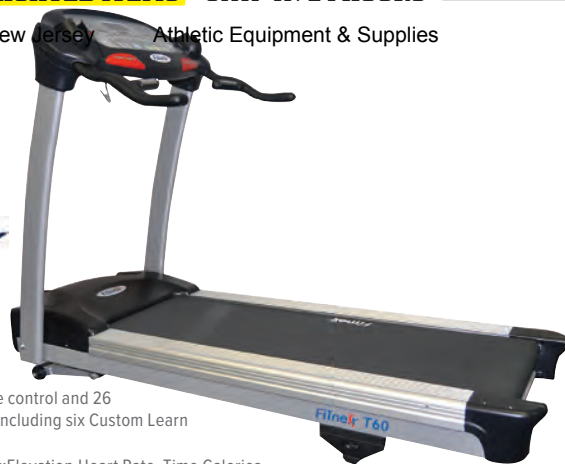

T60 LIGHT COMMERCIAL TREADMILL

- Requires 110 volt power supply
- Includes heart rate control and 26 built-in programs including six Custom Learn programs
- Console Feedback: Elevation, Heart Rate, Time, Calories, Speed, Distance
- Speed: 0.5 - 10MPH
- 58" H x 31" W x 82" L - 256 lbs.
- 350 lbs. maximum user weight

1205886

1248210

\$2,599⁹⁹ EA

\$48⁹⁹ EA



HRM Chest Strap



CT800 LIGHT COMMERCIAL TREADMILL

- Requires 110 volt power supply
- Large blue-LED matrix with 4 Separate LED information windows, a 20-character LED message center, LED heart rate bar and an integrated reading rack
- 9 operation modes: Manual, Interval, 5k, Hill, Fat Burn, Cardio, Fit Test, 2-Hour and Custom
- Contact and telemetric heart rate monitor
- 0 - 15% grade incline and 0.5 - 12 mph speed
- 4.0 hp DC drive motor
- 57" H x 35" W x 84" L - 230 lbs.
- 450 lbs. maximum user weight

5 Year Limited Warranty

1364697

\$3,199⁹⁹ EA



FOAM EQUIPMENT MAT

- Constructed of 1/4" heavy duty closed cell foam
- Economical way to provide added protection to floors
- Aids in reducing noise and is rolled easily for storage
- Pebbled top surface adds non-slip traction for user and equipment

200153X4

20015356

3' x 4' Bike Mat

3' x 4' Treadmill Mat

\$39⁹⁹ EA

\$49⁹⁹ EA





CE-SG FULL COMMERCIAL ELLIPTICAL

- Self-generating power
- 7 built-in programs with 24 levels of resistance, each has 8 class selections that alter the total resistance
- 20" stride with low impact oversized pedals and multi-grip handlebars
- Feedback includes: time, work level, watts, distance, speed, MET's, heart rate and calories burned
- Display: Matrix + LED
- Torque: 250 Watts
- 67"H x 21"W x 73"L - 220 lbs.
- 400 lbs. maximum user weight

3 Year Limited Warranty

1390948

\$3,499⁹⁹ EA



E70 LIGHT COMMERCIAL ELLIPTICAL

- Self-generating power
- 8 built-in programs with 16 levels of resistance
- Feedback includes: time, work level, watts, distance, speed, METs, heart rate and calories burned
- Display: Matrix + LED
- Torque: 250 Watts
- 67"H x 21"W x 73"L - 220 lbs.
- 400 lbs. maximum user weight

1205916

1248210

HRM Chest Strap

\$2,599⁹⁹ EA

\$48⁹⁹ EA



STEPMILL 3

- Requires 110 volt power supply
- Revolving staircase with six, 6"H x 17"W x 9"D steps
- Backlit LCD console display provides easy to read digital and graphical data
- Informative feedback includes: Elapsed time, speed level, calories burned, heart rate, floors
- Step range of 26 to 162 per minute
- Contact and telemetric hear rate monitor
- 73"H x 29"W x 46"L - 227 lbs.
- 300 lbs. maximum user weight

2 Year Limited Warranty

1388450

\$3,899⁹⁹ EA



CE800 ELLIPTICAL

- Large blue-LED matrix with 4 Separate LED information windows, a 20-character LED message center, LED heart rate bar and an integrated reading rack
- 10 operation modes: Manual, Hill, Fat Burn, Cardio, Strength, Interval, Custom, Fit Test, 2 Heart Rate
- Contact and telemetric heart rate monitor
- 40 resistance levels
- Integrated generator and 30 lb. flywheel system
- Oversized foot pedals with 2-degree inversion
- 67"H x 28"W x 78"L - 240 lbs.
- 450 lbs. maximum user weight

5 Year Limited Warranty

1364698

\$2,699⁹⁹ EA



CS800 STEPPER

- This stepper combines the familiar dependent stepping action with an arched step-rail design and impressive 16" maximum step height for an effective lower body workout
- The bright LED screen displays all pertinent information during the workout and a summary of accumulated data scrolls when you have finished
- A turbo cooling fan is standard and this may just be the reason individuals extend their workout by a few minutes
- 20 levels of resistance satisfy the needs of beginners or advanced exercisers
- 63"H x 32"W x 55"L - 175 lbs.
- 450 lbs. maximum user weight

5 Year Limited Warranty

1395527

\$1,599⁹⁹ EA



E GLIDE ELLIPTICAL

- Patent-pending direct drive system
- Large foot pedals with slip-resistant design and sweat drain
- Heavy gauge steel frame
- Easy-to-use console with micro-tension resistance
- Telemetric heart rate
- 66"H x 24"W x 69"L - 230 lbs.
- 450 lbs. maximum user weight

1362077

\$2,499⁹⁹ EA



Bid #ESC NJ 17/18-31

Educational Services Commission of New Jersey

Athletic Equipment & Supplies



Shown with Optional Infotainment Console



CR800 RECUMBENT BIKE

- Extra smooth ride comes from the perfect gearing and the integrated generator/flywheel system
- Console offers multiple programs
- 2 degrees of inversion at the padded foot pedals places the user in a comfortable, anatomically correct position
- 30 lb. flywheel combined with the weight of each crank arm produces the ideal amount of inertia
- 40 levels of resistance to satisfy the needs of beginners or advanced exercisers
- 51"H x 30"W x 57"L - 145 lbs.
- 450 lbs. maximum user weight

5 Year Limited Warranty

1364699

\$1,999⁹⁹ EA



R70 LIGHT COMMERCIAL RECUMBENT BIKE

- For professional light commercial use
- Self-generating power
- 8 built-in programs with 16 levels of resistance
- Feedback includes: time, work level, watts, distance, speed, METs, heart rate and calories
- Display: Matrix + LED
- Torque: 250 Watts
- 45"H x 21"W x 64"L - 165 lbs.
- 400 lbs. maximum user weight

1205909

\$2,149⁹⁹ EA



1248210

HRM Chest Strap

\$48⁹⁹ EA



PR10 COMMERCIAL RECUMBENT BIKE

- 7 Programmed workout settings: Constant load, Weight loss, Interval, CV Workout, Heart Rate Control, Fat Burn, Rolling Hills. Each program has 8 "class" selections that alter the total resistance and can be graphically seen in the "Workout Profile Display"
- Workout Data includes: Time, Heart Rate, Watts, Calories, Distance, METs, Workout Level Speed and RPM.
- 53"H x 29"W x 53"L - 154 lbs.
- 400 lbs. maximum user weight

3 Year Limited Warranty

1205879

\$2,499⁹⁹ EA

1248210

HRM Chest Strap

\$48⁹⁹ EA



Shown with Optional Infotainment Console



CU800 UPRIGHT BIKE

- Large blue-LED matrix display with 4 Separate information windows, a 20-character message center, heart rate bar and an integrated reading rack
- Generator powered console means there is no need for electricity
- Contact and telemetric heart rate monitor
- 40 resistance levels
- Dual spring seat with fore/aft adjustment for extra comfort
- Integrated generator and 30 lb. flywheel system
- 53"H x 21"W x 42"L - 115 lbs.
- 450 lbs. maximum user weight

5 Year Limited Warranty

1386461

\$1,699⁹⁹ EA



B70 LIGHT COMMERCIAL UPRIGHT BIKE

- Built for professional light commercial use
- Self-generating power
- 8 built-in programs with 16 levels of resistance
- Feedback includes time, work level, watts, distance, speed, METs, heart rate and calories
- Display: Matrix + LED
- Torque: 250 Watts
- 53"H x 21"W x 42"L - 117 lbs.
- 400 lbs. maximum user weight

1205909

\$1,699⁹⁹ EA



1248210

HRM Chest Strap

\$48⁹⁹ EA



PB10 COMMERCIAL UPRIGHT BIKE

- 7 Programmed workout settings: Constant Load, Weight Loss, Interval, CV Workout, Heart Rate Control, Fat Burn and Rolling Hills. Each with 8 "class" selections that alter the total resistance and can be graphically seen in the "Workout Profile Display"
- Workout data includes: Time, Heart Rate, Watts, Calories, Distance, METs, Workout Level, Speed and RPM. Data can be viewed in either Alphanumeric or Dot Matrix display
- 60"H x 27"W x 51"L - 139 lbs.
- 400 lbs. maximum user weight

3 Year Limited Warranty

1205862

\$2,299⁹⁹ EA

1248210

HRM Chest Strap

\$48⁹⁹ EA



FitnEX
VELOCITY EXERCISE BIKE

- Heavy-duty adjustable spring/shock rider suspension for greater comfort
- Comfort gel saddle with mid-section cutaway for reduced seating pressure
- Ultra-smooth, quiet Poly-V Drive Belt system needs no-maintenance & can be tensioned without removing drive cover
- 47 lb. stainless flywheel in pillow-block bearing for super-fluid spinning
- Nonskid rubber feet can be adjusted for uneven surfaces
- Ergonomic triathlon-style handle bar offers multiple hand positions
- 55"H x 25"W x 44"L - 129 lbs.
- 300 lbs. maximum user weight

1205855 \$1,099⁹⁹ EA **S&H**



SCHWINN FITNESS
IC PRO20 BIKE

- Professional exercise bike designed for intensive use in institutions and gymnasiums
- Zinc galvanized steel frame with black satin powder coated finish
- Chain drive with forged steel crank and ISIS oversized bottom bracket
- 38 lb. flywheel weight
- Includes transport wheels for easy portability
- 44"H x 22.5"W x 50"L - 130 lbs.
- 350 lbs. maximum user weight

2 Year Limited Warranty
1388448 \$1,369⁹⁹ EA **S&H**



FitnEX
MOMENTUM EXERCISE BIKE

- Professional exercise bike designed for intensive use in institutions and gymnasiums
- 44 lb. flywheel weight
- Sleek look with protective flywheel cover
- Safe pinlocking seat
- Includes transport wheels for easy portability
- 55"H x 20"W x 43"L - 120 lbs.
- 275 lbs. maximum user weight

1272246 \$799⁹⁹ EA **S&H**

CARDIO



StairMaster
AIR FIT BIKE

- Robust full commercial steel frame with black hammertone finish
- Display measurements include: RPM's, Time, Speed, Distance, Heart Rate and Calories
- Dual action arms simultaneously works the upper body
- Adjustable seat accommodates users of different body sizes
- Includes transport wheels for easy mobility
- 58"H x 29"W x 51"L - 123 lbs.
- 350 lbs. maximum user weight

2 Year Limited Manufacturer Approved Co-op #65MCESC CPS Metuchen/Garden State Apparel Bid Term: 5/9/18 - 5/8/20: Extended to 5/8/20
1388449 \$2,399⁹⁹ EA **S&H**



MARCY
AIR-1 EXERCISE FAN BIKE

- Dual action arms simultaneously works the upper body
- Easy to use computer scans functions, tracks speed, time, distance and calories
- Fan flows air past the body providing a cool comfortable feeling
- Adjustable seat accommodates users of different body sizes
- Includes transport wheels for easy mobility
- 47.5"H x 25"W x 45"L - 82 lbs.

1375529 \$499⁹⁹ EA



SPIRIT COMMERCIAL
CIC800 CYCLE TRAINER

- This indoor cycle excels in three critical areas - durability, comfort and performance
- 37 lb. perimeter weighted, high inertia flywheel
- Magnetic resistance with rotary knob, micro adjustment
- Industrial grade Hutchinson Poly-V Belt and ISIS oversized bottom bracket
- 42"H x 21"W x 40"L - 126 lbs.
- 350 lbs. maximum user weight

1395518 \$1,299⁹⁹ EA **S&H**



KETTLEBELLS

- Combine strength training, muscle coordination and aerobic exercise all in one product
- Helps develop muscle tone, strength and flexibility while promoting fat loss
- Can be used for both upper and lower body workouts

1266733	10 lb.	\$22⁹⁹ EA ★	1266801	45 lb.	\$99⁹⁹ EA ★
1266740	15 lb.	\$33⁹⁹ EA ★	1277470	50 lb.	\$129⁹⁹ EA
1266757	20 lb.	\$46⁹⁹ EA ★	1277487	60 lb.	\$149⁹⁹ EA
1266764	25 lb.	\$56⁹⁹ EA ★	1277494	70 lb.	\$169⁹⁹ EA
1266771	30 lb.	\$67⁹⁹ EA ★	1277500	80 lb.	\$189⁹⁹ EA
1266788	35 lb.	\$79⁹⁹ EA ★	1277517	90 lb.	\$209⁹⁹ EA
1266795	40 lb.	\$89⁹⁹ EA ★	1277524	100 lb.	\$229⁹⁹ EA



8" RUBBER KETTLEBELLS

- All sizes (weights) are 8" diameter
- Combine strength training & muscle coordination training
- Develop muscle tone, strength and flexibility while promoting fat loss
- Effective for both upper and lower body work-outs

1361735	6 lb. - Light Blue	\$55⁹⁹ EA ★	1361780	16 lb. - Green	\$89⁹⁹ EA ★
1361742	8 lb. - Red	\$58⁹⁹ EA ★	1361797	18 lb. - Purple	\$96⁹⁹ EA ★
1361759	10 lb. - Yellow	\$65⁹⁹ EA ★	1361803	20 lb. - Light Blue	\$106⁹⁹ EA ★
1361766	12 lb. - Royal Blue	\$72⁹⁹ EA ★	1361810	25 lb. - Red	\$114⁹⁹ EA ★
1361773	14 lb. - Orange	\$81⁹⁹ EA ★	1361827	30 lb. - Yellow	\$124⁹⁹ EA ★



VINYL COATED KETTLEBELLS

- Vinyl coated to protect flooring and reduce noise

1266818	10 lb. - Light Blue	\$27⁹⁹ EA ★
1266825	15 lb. - Red	\$41⁹⁹ EA ★
1267280	20 lb. - Yellow	\$52⁹⁹ EA ★
1267297	25 lb. - Royal	\$67⁹⁹ EA ★
1267303	30 lb. - Orange	\$79⁹⁹ EA ★
1267310	35 lb. - Kelly Green	\$94⁹⁹ EA ★
1267327	40 lb. - Purple	\$109⁹⁹ EA ★
1267334	45 lb. - Black	\$118⁹⁹ EA ★

XD™ KEVLAR® SAND DISCS

- Reinforced with DuPont™ Kevlar® fiber, this extremely durable soft sand disk keeps its shape due to its heavy duty construction
- Can be used the same as you would a kettlebell or medicine ball workout but the shifting sand increases core stability and grip strength
- The soft weight and cover prevents damage to the floor and is safer for the user

1395607	5 lb.	\$29⁹⁹ EA
1395608	10 lb.	\$39⁹⁹ EA
1395609	15 lb.	\$49⁹⁹ EA
1395610	20 lb.	\$59⁹⁹ EA
1395611	25 lb.	\$69⁹⁹ EA
1395612	30 lb.	\$79⁹⁹ EA
1395613	35 lb.	\$89⁹⁹ EA
1395614	40 lb.	\$99⁹⁹ EA
1395615	45 lb.	\$109⁹⁹ EA
1395616	50 lb.	\$119⁹⁹ EA



KETTLEBELL STORAGE RACK

- Holds any size kettlebell on 3 shelves
- Back lip on each shelf prevents fall through

1342611	26"H x 45"W x 23"D	\$299⁹⁹ EA ★
----------------	--------------------	--------------------------------



REACTOR

by CHAMPION BARBELL

RUBBER MEDICINE BALLS

- Durable textured rubber cover makes them easy to grip
- Air filled with limited bounce
- Color coded sizes for easy identification
- Not designed for use in slamming exercises

1266283	2.2 lb. - Light Blue	\$26 ⁹⁹ EA ★
1266290	4.4 lb. - Red	\$33 ⁹⁹ EA ★
1266306	6.6 lb. - Yellow	\$41 ⁹⁹ EA ★
1266313	8.8 lb. - Royal	\$50 ⁹⁹ EA ★
1266320	11 lb. - Orange	\$58 ⁹⁹ EA ★
1266337	13.2 lb. - Green	\$64 ⁹⁹ EA ★
1266344	15.4 lb. - Purple	\$78 ⁹⁹ EA ★
1364666	20 lb. - Gold	\$119 ⁹⁹ EA ★
1364664	25 lb. - Maroon	\$128 ⁹⁹ EA ★
1364665	30 lb. - Dark Green	\$149 ⁹⁹ EA ★



REACTOR

by CHAMPION BARBELL

MEDICINE BALLS

- Traditional design, sizes and weights
- Synthetic leather cover
- Color coded sizes for easy identification
- Not designed for use in slamming exercises

1266238	4-6 lb. - Red	\$19 ⁹⁹ EA ★	1266276	15-16 lb. - Green	\$38 ⁹⁹ EA ★
1266245	6-7 lb. - Yellow	\$24 ⁹⁹ EA ★	1377213	17-18 lb. - Purple	\$40 ⁹⁹ EA ★
1266252	9-10 lb. - Blue	\$29 ⁹⁹ EA ★	1377214	19-20 lb. - Yellow	\$43 ⁹⁹ EA ★
1266269	11-12 lb. - Orange	\$31 ⁹⁹ EA ★			



PowerMax

V2 MEDICINE BALLS

- Features an 18 oz. impact absorbing, moisture resistant, flexible polyurethane shell that is textured for grip
- The hand-sewn casing design and expert construction ensure that the implement remains dimensionally stable and balanced for the life of the ball
- All weights are 14" in diameter

PMTA1361	4 lb.	\$84 ⁹⁹ EA
PMTA1362	6 lb.	\$94 ⁹⁹ EA
PMTA1363	8 lb.	\$99 ⁹⁹ EA
PMTA1364	10 lb.	\$104 ⁹⁹ EA
PMTA1365	12 lb.	\$109 ⁹⁹ EA
PMTA1366	14 lb.	\$114 ⁹⁹ EA
PMTA1367	16 lb.	\$119 ⁹⁹ EA
PMTA1368	18 lb.	\$124 ⁹⁹ EA
PMTA1369	20 lb.	\$134 ⁹⁹ EA



XD™ KEVLAR® MEDICINE BALL

- These medicine balls are indestructible and you can drop, pass, throw and slam them with confidence
- The cover material contains Dupont™ Kevlar® brand fiber and features a special texture for maximum grip and control
- Sewn in logo and weight identifiers won't wear off like printed labels
- Specifically designed for limited bounce

1388454	10" - 4 lb.	\$89 ⁹⁹ EA
1388455	10" - 6 lb.	\$94 ⁹⁹ EA
1388456	10" - 8 lb.	\$99 ⁹⁹ EA
1388457	10" - 10 lb.	\$104 ⁹⁹ EA
1388458	10" - 12 lb.	\$109 ⁹⁹ EA
1388459	14" - 14 lb.	\$119 ⁹⁹ EA
1388460	14" - 16 lb.	\$124 ⁹⁹ EA
1388461	14" - 18 lb.	\$129 ⁹⁹ EA
1388462	14" - 20 lb.	\$134 ⁹⁹ EA
1388463	14" - 25 lb.	\$144 ⁹⁹ EA
1388464	14" - 30 lb.	\$144 ⁹⁹ EA



REACTOR

by CHAMPION BARBELL

SMASH BALLS

- Specifically designed to smash and slam without bouncing or rolling
- Durable textured cover to withstand the most demanding slam workouts
- Latex free PVC cover will not split or crack
- Sand filled center shifts with exercise movements to engage core and stabilizer muscles
- Ball diameter varies from 7" to 10" depending on weight

1375501	6 lb. - 7" Dia.	\$32 ⁹⁹ EA ★
1375502	8 lb. - 7" Dia.	\$36 ⁹⁹ EA ★
1375503	10 lb. - 7" Dia.	\$41 ⁹⁹ EA ★
1375504	15 lb. - 9" Dia.	\$51 ⁹⁹ EA ★
1375505	20 lb. - 9" Dia.	\$56 ⁹⁹ EA ★
1375506	25 lb. - 9" Dia.	\$61 ⁹⁹ EA ★
1375507	30 lb. - 10" Dia.	\$71 ⁹⁹ EA ★
1375508	35 lb. - 10" Dia.	\$71 ⁹⁹ EA ★

Bid #ESCNJ 17/18-31

Educational Services Commission of New Jersey

Athletic Equipment & Supplies



REACTOR
CHAMPION BARBELL
WORK OUT BAR

- 48" long weighted steel bars
- Rubber coated foam covers bars for easy grip while exercising
- Great for incorporating into squats, lunges, dead lifts, bicep curls and dead rows
- Color coded sizes for easy identification

1266467	4 lb.	\$26 ⁹⁹ EA ★
1266474	6 lb.	\$32 ⁹⁹ EA ★
1266481	9 lb.	\$35 ⁹⁹ EA ★
1266498	12 lb.	\$40 ⁹⁹ EA ★
1266504	15 lb.	\$45 ⁹⁹ EA ★
1266511	18 lb.	\$50 ⁹⁹ EA ★



REACTOR
CHAMPION BARBELL
WORKOUT BAR STORAGE RACK

- 16-gauge powder coated rectangular tube and cold rolled steel construction
- Some assembly required
- Holds up to 35 bars depending on size

1205572	41.5" H x 24.25" W x 20" D	\$169 ⁹⁹ EA ★
---------	----------------------------	--------------------------



REACTOR
CHAMPION BARBELL
WORK OUT BAR CART

- Rigid tubular steel design easily stores large quantities of weighted work out bars
- Black powder coated finish
- 6 tiers on each side
- Heavy-duty casters with locking feature on 2

1367751	48" H x 34" W x 25" D	\$224 ⁹⁹ EA ★
---------	-----------------------	--------------------------



REACTOR
CHAMPION BARBELL
AEROBAR

- Rather than lifting static weight, user resists the force of moving weight
- Provides up to 250 muscle contractions per minute
- Great for general fitness, sport-specific training, rehab, strength and aerobic conditioning
- Heavy-duty composite material with comfort grip handle and padded rubber base

1369601	48" L	\$29 ⁹⁹ EA ★
---------	-------	-------------------------



NEW!
RMT CLUB

- The RMT Club is ideal for improving athletic movement, balance, coordination, and helping unify both sides of the body
- It offers you a complete full body workout as well as the ability to focus on specific targeted area
- You can also use the "shifting weight" inside for dynamic resistance training

1395630	2 lb.	\$119 ⁹⁹ EA
1395631	4 lb.	\$129 ⁹⁹ EA
1395632	6 lb.	\$139 ⁹⁹ EA
1395633	8 lb.	\$149 ⁹⁹ EA

NEW!
CORE HAMMER

- With the MostFit Core Hammer you no longer need a bulky tire for a sledgehammer workout
- Swing it like a sledgehammer against the ground, driveway, cement floor or, use it like a mace to develop shoulder strength
- The long lever and distally loaded end provide endless options for unilateral and asymmetrical strength challenges, core exercises and rotational, mobility and stability work
- 2 year manufacturers warranty

1395635	12 lb.	\$329 ⁹⁹ EA
---------	--------	------------------------



FITNESS RINGS

- Rings are molded durable Lexan plastic
- Straps are 1 3/4" wide heavy-duty nylon webbing with leveling markings for quick adjustment
- Includes two 1.1" diameter rings, two 19" L straps with

PMTA1598		\$119 ⁹⁹ PR
----------	--	------------------------

Bid #ESCNJ 17/18-31

Educational Services Commission of New Jersey

Athletic Equipment & Supplies

CORE



REACTOR
CHAMPION BARBELL

VERTICAL MEDICINE BALL RACK

- Heavy duty square steel construction with durable black powder coated finish
- Holds 5 balls

1033267 66"H x 16"W x 25"D \$114.99 EA ★



REACTOR
CHAMPION BARBELL

2-SIDED MEDICINE BALL RACK

- Heavy duty square steel construction with durable black powder coated finish
- Holds 8 balls

1033250 58"H x 24"W x 30"D \$149.99 EA ★ S&H



REACTOR
CHAMPION BARBELL

ROLLING MEDICINE BALL RACK

- 6 tiers, holds 24 medicine balls
- Holds balls up to 16" in diameter
- Silver powder coated finish
- 4 heavy-duty lockable swivel casters

1367628 72"H x 29"W x 29"D \$324.99 EA ★



SQUARE MEDICINE BALL REBOUNDER

- Square rebounder that returns balls with speed, force and angle consistent with your throw
- The angle of inclination adjusts from 0-60 degrees
- The 39" diagonal surface measures 27.5" x 27.5"
- Built-in tray to hold balls when not in use

1375497 \$539.99 EA S&H



ROUND MEDICINE BALL REBOUNDER

- Heavy-duty tubular steel frame with 28" diameter rebound area
- Solid handle with neoprene grip
- Adjustable for different rebound angles
- Built-in tray to hold balls when not in use

1395597 43"H x 40"W x 40"D \$349.99 EA



MONSTER BALL CART

- Fabricated from 1" square steel
- Black powder coated finish
- Non-marring casters
- Holds 15 official size basketballs

1162608 30"H x 49"W x 20"D - 30 lbs. \$299.99 EA ★

Mueller
WHIZZER®

- Multipurpose concentrate kills HIV-1 (AIDS virus), MRSA, Hepatitis B & C, and other viruses. Kills strep, staph and fungus germs on contact.
- Cleaner, fungicide, mildewstat, virucide and deodorizer - all in one. Comes complete with 2 FREE Pint spray bottles.
- Economical. One ounce of concentrate mixed with water makes a gallon of full-strength disinfectant. 128 dilutions per gallon.
- Fast. Apply directly to mats, floors, walls, training tables, locker rooms, or personal items. Just wipe dry.



1155235 1 Gallon + 2 FREE Pint Spray Bottles \$62.99 EA



HANDHELD FITNESS BALLS

- Soft, weighted vinyl balls fit comfortably into the palm of the hand
- Incorporate into matwork routines to increase intensity and bring awareness to shoulder girdle stability or target desired muscle groups

1266351 1 lb. - Green \$9.99 EA ★
 1266368 2 lb. - Red \$10.99 EA ★
 1266379 3 lb. - Yellow \$11.99 EA ★
 1266382 4 lbs. - Royal \$12.99 EA ★

NJ State Approved Co-op #65MCESCCPS Metuchen/Garden State AppareBid Term: 5/9/18 - 5/8/20: Extended to 5/8/21



SKLZ
CORE WHEELS

- Develops dynamic core strength
- Ability to tone the muscles of the entire midsection at once from a variety of different angles
- Allows for more push-up variations to target the upper body area
- Improve flexibility through a series of active stretches

1375527

\$49⁹⁹ PR



AB WHEEL

- Tones and strengthens the abdominals
- Double wheel for added stability

MSABWHLX

\$16⁹⁹ EA ★



REACTOR
AB MAT

- Abdominal exerciser and core trainer supports lower back for proper positioning
- Safe, comfortable design to help prevent injury
- Designed to take anywhere

1369609

\$29⁹⁹ EA



REACTOR
AB STRAPS

- Attaches to any pull up bar
- Ideal for training the hard to hit lower abdominals
- Now featuring heavy-duty steel carbineers

1277463

\$38⁹⁹ EA



POWERMAX
PEGBOARD CLIMBERS

- Turn empty walls into active training and testing areas
- Pegboards provide challenge while increasing arm and shoulder strength
- Manufactured of 1 1/2" thick hardwood with clear coat varnish finish
- Comes complete with two hand-grip pegs
- Wall mounting brackets and replacement pegs sold separately

- 1. 1375518
- 2. 1375519
- 1375520
- 1375521

- 60"H x 15"W
- 30"H x 30"W
- Mounting Bracket
- Replacement Pegs

- \$449⁹⁹ EA
- \$449⁹⁹ EA
- \$139⁹⁹ PR
- \$19⁹⁹ PR

1.

2.



WALL MOUNTED ADJUSTABLE PULL UP BAR

- Powder coated solid steel bar and frame is adjustable in 6" increments within a 30" range
- Frame attaches to steel stringers and is removable for storage
- Bar is 40"L x 1" O.D. - 29 lbs.
- Stringers are each 54" long with mounting holes 24" apart; mount 37 1/2" center to center
- Mounting hardware not included

1137286

\$224⁹⁹ EA ★



WALL MOUNT MULTI-GRIP PULL UP BAR

- All steel construction
- Extremely durable powder coated Hammertone Grey finish
- 1 1/4" diameter bar covered with durafoam grips
- Multiple grip positions satisfies all types of pull up exercises
- Mounting hardware not included

1276749

20"H x 50"W x 19"D

\$144⁹⁹ EA ★

POWERMAX
MULTI-STATION CHINNING BAR

- 10'L chinning bar with 3 stations
- Mounts 16" away from wall
- 1" solid steel diameter grip with a durable zinc plated finish
- Ideal for mounting fitness rings (see page 276) or other popular suspension training

PM00196013

\$524⁹⁹ EA



Bid #ESCNJ 17/18-31

Educational Services Commission of New Jersey

Athletic Equipment & Supplies

CORE



STROOPS
SLASTIX® TONER

- Slastix technology incorporates a Safety Sleeve that encloses latex tubing that protects it from wear, nicks and cuts
- Sleeve also provides safety stretch limitations during resistance training
- 4' long with comfortable handles on each end

1300260	Very Light - Purple	\$18.99	EA
1301472	Light - Yellow	\$20.99	EA
1301489	Medium - Red	\$22.99	EA
1301496	Heavy - Blue	\$24.99	EA
1301502	Very Heavy - Green	\$26.99	EA

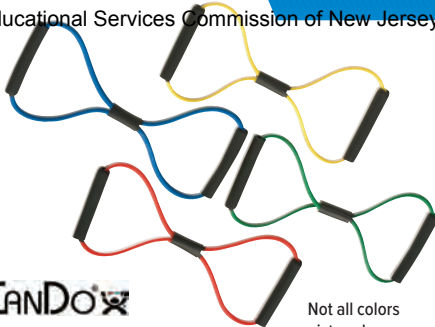

CANDO
BOWTIE TONERS

Not all colors pictured

- Medical latex tubing offers safe variable resistance and full range of motion muscle conditioning
- The patented figure-eight design offers maximum resistance, while giving you the results you are looking for
- Choose from 7 levels of resistance and all are 22" long
- Comfortable foam covered handles

1395557	XX-Light - Tan	\$4.99	EA
1395558	X-Light - Yellow	\$5.99	EA
1395559	Light - Red	\$6.99	EA
1395560	Medium - Green	\$7.99	EA
1395561	Heavy - Blue	\$8.99	EA
1395562	X-Heavy - Black	\$9.99	EA
1395563	XX-Heavy - Grey	\$10.99	EA



CANDO
EXERCISE TUBES WITH HANDLES

- Includes comfortable foam covered plastic handles
- Perform lower body, upper body and core conditioning exercises with our multi-use resistance tubes
- Isolate muscles or use as a full range of motion exerciser
- Choose from 5 levels of resistance and all are 48" long



1249798	X-Light - Yellow	\$9.99	EA
1249804	Light - Red	\$10.99	EA
1249811	Medium - Green	\$11.99	EA
1249828	Heavy - Blue	\$13.99	EA
1342574	X-Heavy - Black	\$14.99	EA



REACTOR
BULK FITNESS BANDS

- 6"W x 150'L latex rolls
- Save money by cutting to desired lengths
- 4 resistance levels for all ages
- Use as a single ply or double up for more resistance

1266528	Pink; Pre-School-Elementary	\$54.99	ROLL	★
1266535	Green; Intermediate	\$61.99	ROLL	★
1266542	Purple; High School	\$83.99	ROLL	★
1266559	Grey; Adult	\$87.99	ROLL	★



TUBING HANDLES

- Pressure-locking system holds tubing in position so you can set the length and control the range of motion
- Switch out tubing for different resistance levels

1279955	\$18.99	PR
---------	---------	----



REACTOR
25' BULK TUBING

- Perfect for when you need quality and quantity
- Cuts easily with scissors so you can customize the length to suit your needs
- Handles not included
- Available in 3 resistance levels

1277562	Medium - Red	\$22.99	EA
1277579	Heavy - Blue	\$23.99	EA
1277586	X-Heavy - Black	\$24.99	EA



STROOPS
SLASTIX® PRO POWER BAND

- Slastix technology incorporates a Safety Sleeve that encloses the latex tubing to protect it from wear, and provides stretch limitation during training
- The Pro Power Band is two 48" bands attached by a 10" fabric loop that can be attached to virtually any stationary support and 2 handles on either end

1379880	Very Light - Purple	\$36.99	EA
1379881	Light - Yellow	\$38.99	EA
1379882	Medium - Red	\$40.99	EA
1379883	Heavy - Blue	\$42.99	EA
1379884	Very Heavy - Green	\$44.99	EA
1379885	Super Heavy - Silver	\$46.99	EA

CHAMPION BARBELL
RESISTANCE TUBE STANDING RACK

- Neatly holds 128 ropes or 40 tubes
- Casters provide easy mobility
- 1.5" square tube construction with white powder coated finish

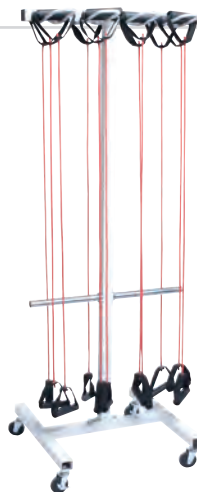

1281101	60"H x 20"W x 20"D - 25 lbs.	\$114.99	EA	★
---------	------------------------------	----------	----	---

REACTOR
BODY LOOP BANDS

- Closed loop design fits comfortably around the upper and lower legs
- 12" long loops are ideal for short, limited movements while the 22" long loops are suited for more dynamic movements with a greater range of motion



1301700	12" - Light - Orange	\$5.99	EA	★
1301717	12" - Light/Medium - Red	\$6.49	EA	★
1301724	12" - Medium - Blue	\$6.99	EA	★
1301731	12" - Heavy - Green	\$7.49	EA	★
1301755	22" - Light - Orange	\$9.99	EA	★
1301762	22" - Light/Medium - Red	\$10.99	EA	★
1301779	22" - Medium - Blue	\$11.49	EA	★
1301788	22" - Heavy - Green	\$13.49	EA	★

NEW!

POWER SYSTEMS

PREMIUM STABILITY BALL RACK

- Get stability balls off the floor and out of the way when not in use
- Arrange them by size for easy identification
- Top level holds balls up to 85 cm, other levels hold balls up to 65 cm
- White Tubular steel frame with 9" diameter metal rings

1395534 63"H x 20"W - 36 lbs. **\$249⁹⁹** EA

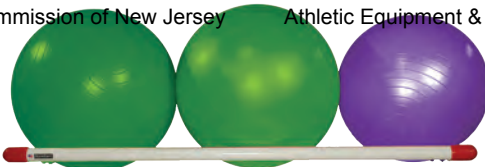

1.



STABILITY BALL STORAGE

- Stores and safely transports stability balls with a diameter of 16" or larger, plus jump ropes, exercise bands and resistance tubes
- Lightweight PVC, yet strong, durable and maintenance free
- Roll lock casters secure cart in place with the push of a lever
- Easily passes through a standard doorway
- Wall mounted stability ball rack (mounting hardware not included)
- Conveniently holds 3 medium or 2 large fitness balls

1. **1257557** Cart - 67"H x 67"W x 19"D **\$279⁹⁹** EA
 2. **1369556** Wall Rack - 55"W x 18"D **\$69⁹⁹** EA

EASILY FASTENS WITH HOOK AND LOOP FASTENER

POWER SYSTEMS

BALL STORAGE STACKERS

- Convenient way to store stability balls
- Fasten each stacker with its Velcro attachment to form a circular stacking ring
- Can hold 45cm to 75cm balls

1279887 **\$34⁹⁹** SET OF 3



BALLS SOLD SEPARATELY.



SMART STABILITY BALLS

- The Smart Stability Balls are self-guided for users at all fitness levels
- 13 exercises are printed on ball for easy reference
- Burst-resistant PVC construction
- Includes pump

1379892 55cm - Yellow **\$31⁹⁹** EA
 1379964 65cm - Green **\$34⁹⁹** EA
 1379965 75cm - Blue **\$39⁹⁹** EA

CANDO



24" BALANCE DISK



- Promotes core stability and provides many of the same benefits of a stability ball while performing lower back and abdominal exercises
- Support and challenge the spinal muscles while enhancing posture
- The tactile surface has been shown to enhance calmness and concentration
- Perform exercises while sitting, kneeling, or lying on top of the disc for dynamic stabilization training
- Inflation requires a standard foot or hand air pump (not included)
- Supports up to 400 lbs

1377194 Specify Color **\$54⁹⁹** EA

CANDO



13" BALANCE DISK

- Improves coordination, stability, posture and motor skills
- Resembles the sensation of the stability ball and works the core and stabilizer muscles in a more compact environment
- Place them in a chair to help support and challenge the spinal muscles while enhancing posture
- Use two discs for double arm and leg activities such as push ups and squats
- Uses standard needle inflation (pump included)



1377189 Specify Color **\$24⁹⁹** EA

Bid #ESCNJ 17/18-31

Educational Services Commission of New Jersey

Athletic Equipment & Supplies



REACTOR
CHAMPION BARBELL

STABILITY BALL WITH FEET

- Burst-resistant ball with the addition of small peg feet
- Provides all of the ergonomic seating benefits of a traditional stability ball, but stays put when not in use
- Can also be used on its side like a regular stability ball
- 600 lb. weight limit

1333909	45cm - Light Blue	\$27 ⁹⁹ EA ★
1333916	55cm - Red	\$29 ⁹⁹ EA ★
1333923	65cm - Yellow	\$34 ⁹⁹ EA ★



BEST SELLER

REACTOR
CHAMPION BARBELL

CORE STABILITY BALLS

- Improve and maintain balance, coordination, posture and flexibility
- Strengthens hard-to-reach muscles often overlooked in normal training
- Use to perform a variety of balance, core, strength, flexibility and rehabilitation exercises
- 600 lb. weight limit

1335873	45cm - Purple	\$18 ⁹⁹ EA ★
1335880	55cm - Green	\$20 ⁹⁹ EA ★
1335897	65cm - Yellow	\$24 ⁹⁹ EA ★
1335903	75cm - Red	\$27 ⁹⁹ EA ★



CORE



REACTOR
CHAMPION BARBELL

ANTI-BURST FITNESS BALLS

- Target abs, back and glutes to strengthen and tone
- Advanced users position the ball for upper and lower body workouts
- Ideal for stretching and warm-up exercises
- Burst resistant up to 600 lbs.

1335910	45cm - Purple	\$28 ⁹⁹ EA ★
1335927	55cm - Green	\$30 ⁹⁹ EA ★
1335934	65cm Yellow	\$32 ⁹⁹ EA ★
1337211	75cm - Red	\$38 ⁹⁹ EA ★



WHAT BALL IS RIGHT FOR YOU?

45CM	=	4'6" TO 5'0"
55CM	=	5'1" TO 5'7"
65CM	=	5'8" TO 6'1"
75CM	=	6'2" AND UP

BODY BALL EXERCISES



BODY BALL POSTER SET

- Includes 2 posters featuring an upper and lower body poster and a core poster
- See how to do variations of ball exercises

1389843

NJ State Approved Co-op #65MCESCPS Metuchen/Garden State Appar Bid Term: 5/9/18 - 5/8/20 Extended to 5/8/21

24" x 36" Laminated

42 SET OF 2

14" TWO WAY HAND PUMP

- Works well for larger inflation jobs
- 14" long

1300239

\$9⁹⁹ EA ★



BEST SELLER

ECONOMY ELECTRIC INFLATOR

- High impact plastic desktop inflator
- 120v and .9 amps
- 100 psi gauge
- Coiled inflation tube that will stretch to 30"

MSECOLEY

\$99⁹⁹ EA ★



DUAL-DENSITY WORKOUT MAT

- Extra-tough Polyethylene mat for yoga, pilates, stretching and exercise
- Dual density foam is strong on the inside and soft on the outside
- Cut out carry handle

1271027 48" L x 24" W x 1" \$39.99 EA ★

GAMECRAFT® ACTIVITY MAT

- Durable but soft mat with a patented self-sealing foam will not tear, peel or split under normal use
- Mat can be stored flat or rolled up
- Water resistant for easy maintenance and comes with built-in handles

7137XXXX 48" L x 24" W x 3/8" \$20.99 EA ★



HANGING WORKOUT MATS

- Reinforced grommets allow mats to hang for storage

1277159 48" L x 20.5" W x 3/8" - Red \$39.99 EA ★
 1277197 72" L x 24" W x 5/8" - Blue \$59.99 EA ★

HANGING MAT RACK

- Height and width adjustments allow this rack to work with different length and width hanging mats
- Constructed of 1.5" and 1.25" square steel tubing with Silver powder coated finish
- Holds up to 50 - 48" or 32 - 72" mats or a combination of both
- Equipped with 4 non-marring polyurethane swivel casters; 2 locking

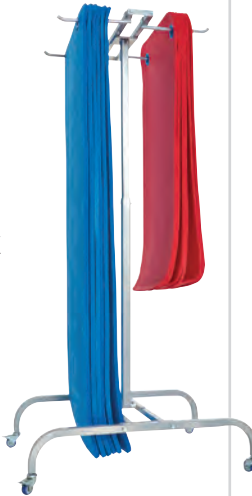

1378641 Cart Only 74" H x 28" W x 36" L - 39 lbs. \$199.99 EA ★
 1388485 Cart + 24 Mats (48" L x 20.5" W x 3/8") \$799.99 PACK ★
 1388486 Cart + 24 Mats (72" L x 24" W x 5/8") \$1,299.99 PACK ★

SMART MAT PRINTED EXERCISE/STRETCHING MAT

- The Smart Mat has 14 Core Exercises printed on one side and 14 Stretching Poses on the other side for easy reference
- The mat features a durable, non-slip surface and is easy to clean
- Includes grommets for easy hanging storage



1379891 72" L x 24" W x 6mm \$54.99 EA



PACMAT 100

- Composed of Nitrile® rubber
- Offers maximum comfort and impact resistance
- The patented cellular foam will not crack, peel or tear under normal use
- Water resistant for easy maintenance

PACMAT 75" L x 24" W x 7/16" \$29.99 EA ★



2' X 6' FOLDING



ECONOMY EXERCISE MATS

- Resilient foam covered with a durable vinyl
- Handles are at each end for easy carrying

GCMAT241 48" L x 24" W x 1" - Non-Folding \$39.99 EA ★





YOGA STRAPS

- Assists with achieving the proper pose or position
- Excellent tool for increasing flexibility
- Buckle allows you to adjust the strap length
- Available in 6' or 8' lengths

1301922	6' Long	\$12.99 EA
1301939	8' Long	\$14.99 EA



YOGA BLOCKS

- For additional support during transitions and poses
- Available in 3" or 4" thickness
- Blue only

1301946	3" Thick	\$16.99 EA
1301953	4" Thick	\$18.99 EA



AEROBIC MAT

- The ideal stretching and exercise mat, durable yet soft
- Use for aerobics or under your yoga mat
- Beveled edges have sealed borders on all 4 sides
- Can be rolled for storage
- Black pebble finish

1235005	60" L x 24" W x 3/8"	\$39.99 EA ★
---------	----------------------	--------------



CAN DO BALANCE PAD

- The CanDo Balance Pad combines both exercise and coordination skills
- Widely used for rehabilitation and sports conditioning
- Super soft, closed cell foam pad forces active recruitment of the foot's muscular system, increasing strength, stamina and mobility
- Impervious to water, easy to clean and long-lasting

1388425	20" L x 16" W x 2 1/2" D	\$54.99 EA
---------	--------------------------	------------



BEST SELLER



RIBBED MULTI-PURPOSE MATS

- Closed cell foam is great for repelling water or stains
- Hygienic, easy to clean and easily rolled for storage
- Non-slip, hard-wearing and long lasting
- Warm and comfortable to the touch

1022391	56" L x 23" W x 3/4" - Red	\$39.99 EA ★
1013047	72" L x 39" W x 5/8" - Blue	\$54.99 EA ★



YOGA MAT

- Lightweight, durable sticky mat
- Cushioned non-slip surface
- Hand washable, air dry

1240146	68" L x 24" W x 1/8"	\$19.99 EA ★
---------	----------------------	--------------

SKLZ

RECOVERY MASSAGERS

- The unique texture of these massagers stimulates circulation and relieves pain and discomfort
- Universal Massage Roller is designed to target the aches and pains of the back and spine
- Targeted Massage Ball provides deep tissue compression massage in those hard to reach places
- Foot Massage Ball is ideal for targeting small muscles and rolling out your feet and hands
- The Massage Bar provides myofascial release therapy to get rid of knots and helps sore muscles recover faster



1395620	Universal Massage Roller - Red	\$19.99 EA
1395621	5" Targeted Massage Ball - Black	\$14.99 EA
1395622	2.5" Foot Massage Ball - Yellow	\$9.99 EA
1395623	Massage Bar	\$29.99 EA



REACTOR CHAMPION BARBELL BARREL ROLLER

- This deep tissue roller has a molded plastic core for shape retention and is covered in a multi-textured thick rubber-foam
- The textured surface is great for both myofascial release and knotted-muscle trigger-point relief
- The hard plastic core allows for maximal weight application
- Available in Black only



1388452	5.5" H x 5.5" W x 15" L	\$29.99 EA
---------	-------------------------	------------

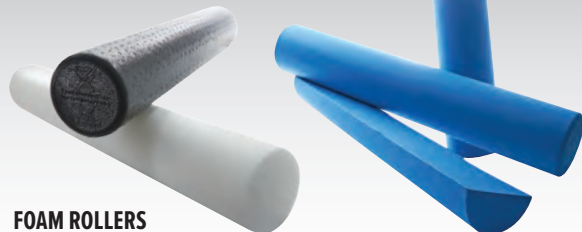

FOAM ROLLERS

- Available in 3 firmness levels, medium-firm White PE foam, firm Blue EVA foam, extra-firm Black Molded foam
- Helps develop balance, postural alignment and flexibility
- Ideal for self-myofascial release and massage therapy

1377211	White - 36" x 6" Round - Medium Firm	\$29.99 EA
1277111	Blue - 36" x 6" Round - Firm	\$45.99 EA ★
1277128	Blue - 18" x 6" Round - Firm	\$25.99 EA ★
1277135	Blue - 36" x 2" Half Round - Firm	\$25.99 EA ★
1377212	Black - 36" x 6" Round - Extra Firm	\$31.99 EA



BOSU®



BOSU® PRO TRAINER

- Targets the core muscles of your body helping you to not only gain strength, trim, and tone, but to help coordinate your entire body
- Ideal for static and dynamic balance training
- Can also be used to integrate balance challenges into cardiovascular, endurance, core and flexibility training
- Can be used with the platform side either up or down to challenge balance with different body positions
- Includes a workout DVD, an inflation pump, a healthy diet guide for weight loss and a 120 page integrated balance training book
- Supports up to 300 lbs.
- 25" diameter x 12"H

90 Day Limited Warranty

1205732

For the Instructor

\$219⁹⁹ EA

BOSU® BALANCE TRAINER - PRO BASIC

- Same as the BOSU Balance Trainer Pro model but with inflation pump only

1388424

For the student

\$189⁹⁹ EA



BOSU® 3D SCULPTING UNIT

- This product serves as a built in spotter so new users are able to perform BOSU® Balance Training exercises with ease, and progress at their own level to maximize success
- Features BOSU® 3D Docking Station, adjustable balance bar with padded grip, and wheels for easy transport, and 2 adjustable resistance tubing attachments
- Includes owner's manual and a 3-in-1 workout DVD
- Balance trainer sold separately
- 300 lbs. maximum user weight

1395549

49"L x 29"W x 39"H - 25 lbs.

\$179⁹⁹ EA



BOSU® POWER STAX

- BOSU Stax increases the intensity of your workout at different heights
- Creates unlimited options for advanced exercises and explosive power and agility drills
- Each BOSU Stax measures 24"W x 3"H
- BOSU balance trainer sold separately

1375490

Single

\$119⁹⁹ EA

1375530

Set of 3

\$299⁹⁹ SET



BOSU® SPORT BALANCE TRAINER

- New, redesigned smaller version of the original BOSU Balance Trainer and is constructed with the same rim and base style
- The sleek, compact 22" design allows for easy transportation and storage, quick positioning for any type of workout and is ideal for fitness enthusiasts and athletes of all ages
- Includes inflation pump and owners manual
- 250 lbs. maximum user weight

1388422

Specify Color

\$119⁹⁹ EA



BOSU® STORAGE RACK

- Solid steel construction for durability and locking casters for portability
- Stores up to 8 BOSU's
- Some assembly required

1378678

\$199⁹⁹ EA



BSN SPORTS™

POWER-PLYOMETRIC BOXES

- Great for improving explosiveness, speed, vertical jump and endurance
- Constructed of 1" O.D. 16-gauge, fully welded Black powder coated, square steel tubing
- Landing surface area varies by height of box
- Nesting stackable for compact easy storage
- 400 lbs. maximum user weight
- For indoor or outdoor use

1395573	12"H	\$129 ⁹⁹	EA
1395574	18"H	\$138 ⁹⁹	EA
1395575	24"H	\$159 ⁹⁹	EA
1395576	30"H	\$174 ⁹⁹	EA
1395577	36"H	\$194 ⁹⁹	EA
1395578	42"H	\$214 ⁹⁹	EA
1395579	Starter Set (1-12, 18, 24, 30 in.)	\$459 ⁹⁹	SET
1395580	Advanced Set (1-12, 18, 24, 30, 36, 42 in.)	\$829 ⁹⁹	SET



CORE



CHAMPION BARBELL HEAVY DUTY PLYO BOX SET

- Set of 4 Plyo Boxes includes one of each: 12", 18", 24" and 30" high
- Stackable for easy storage
- Large 1 1/8" thick non slip landing surface
- Fully welded steel construction with gray powder coated finish
- Floor protectors for indoor or outdoor use
- Can be used by athletes up to 400 lbs.
- Ships fully assembled



1258318

\$844⁹⁹ SET ★



ALLOW 3-4 WEEKS FOR CUSTOM COLORS.

FOAM PLYO BOXES

- Large 30" x 36" landing surface eliminates athlete's fear of missing the box
- Constructed of 100% Naugahyde and premium density polyethylene foam that will not break down, de-laminate or soften over time
- Includes handles, Velcro tabs to secure boxes together and compression vents for air release
- Sold in sets of 3 only: 1 - 6", 1 - 12", 1 - 18"
- Custom color options: Navy, Royal, Light Blue, Dark Green, Kelly, Yellow, Athletic Gold, Orange, Scarlet, Maroon, Purple, White
- 3 in 1 Plyo Cube is 20"H x 24"W x 30"L - 30 lbs. (Black Only)

1382826	BSN Sports - Black	\$949 ⁹⁹	SET	
1378907	3 in 1 Plyo Cube	\$999 ⁹⁹	SET	
1390951	3 in 1 Plyo Cube	\$349 ⁹⁹	EA	

NJ State Approved Co-op #65MCESCPS Metuchen/Garden State App... Extended to 5/8/21

Bid #ESC NJ 17/18-31

Educational Services Commission of New Jersey

Athletic Equipment & Supplies



1.



2.



3.

THE ORIGINAL CLUB STEP

- The Club Step features a non-slip, 40" x 14" top surface and will support up to 300 lbs.
- The Club High Step features a non slip, 13" x 9" top surface stackable up to 12.5"H and will support up to 275 lbs.
- The Angled Step Riser is designed specifically for use with the Original Club Step™ and includes a exercise DVD for strength, cardio and interval training programs.

1. 1158656	Club Step	\$129 ⁹⁹ EA
2. 1377151	High Step	\$99 ⁹⁹ EA
3. 1256383	Riser Only	\$63 ⁹⁹ PR

THE CIRCUIT STEP

- Adjusts from 4" to 6" to 8" by adding or subtracting the support blocks
- Features a non-slip, 25"L x 11"W top surface
- Each step includes one 4"H platform and four 2"H support blocks
- Will support up to 200 lbs.

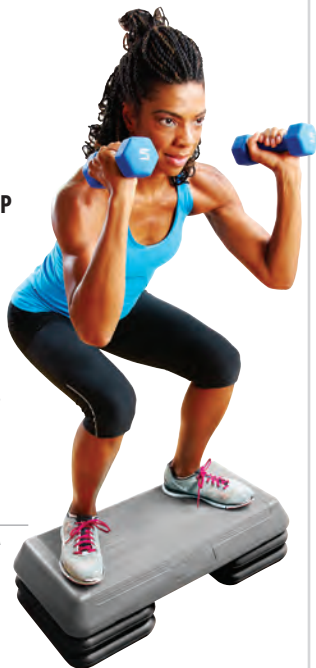

1158632 \$75⁹⁹ EA

REACTOR
CHAMPION BARBELL

4" AND 6" FITNESS STEPS

- Constructed of high density polyethylene designed for schools, YMCA's, public recreational and health facilities
- Rounded corners reduce the risk of injury from rough edges
- Additional safety features include non-slip, dimpled top and non-skid bottom with rubber feet
- Top surface area is 24"L x 15"W

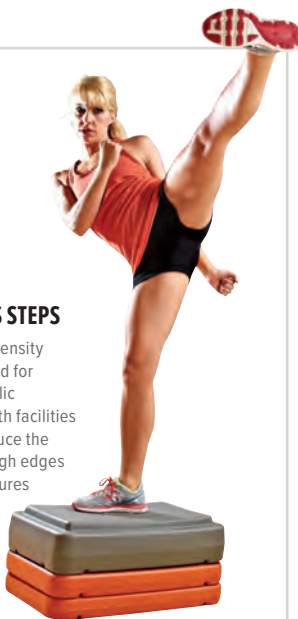

1292619	Orange 4" Step	\$29 ⁹⁹ EA ★
1292626	Grey 6" Step	\$34 ⁹⁹ EA ★
1292633	10 Pack of Orange 4" Steps	\$279 ⁹⁹ SET ★
1292640	5 Pack of Grey 6" Steps	\$165 ⁹⁹ SET ★

FITNESS STEP CART

- Large capacity storage rack and transporter for fitness steps and resistance tubes
- Lightweight and durable
- This cart will safely store up to (32) 4" steps or (16) 6" steps plus resistance tubes
- Features include heavy-duty, ball bearing, swivel, non-marring casters with a roll lock feature
- Easily goes through standard doorway

1188332 60" H x 45" W x 19" D \$269⁹⁹ EA

SKLZ
SLIDEZ

- Supports engagement of the core through countless movements
- Proprietary low-friction, non-marring material slides smoothly on most surfaces
- Felt lined "Court Slidez" can be used on hardwood/gym floors without scratching
- Ergonomic tread pattern ideal for better grip
- Omnidirectional shape for movement in any direction

1386491	Multi-Surface	\$29 ⁹⁹ SET
1395543	Indoor Use Only	\$29 ⁹⁹ SET



FREESTYLE CIRCUIT STEP

- Non-slip surface platform that supports up to 275 lbs.
- 25"L x 11"W stepping surface
- Overall dimensions: 6 1/4"H x 14 1/2"W x 29"L - 9 lbs.
- Includes: (1) Platform, (2) Freestyle Risers and (2) Workout

1333954 \$69⁹⁹ EA



LICORICE ROPES

- Perfect for beginners or experienced jumpers who want the best
- Great for speed jumping and a favorite with jump teams
- Injection molded handles designed for comfort and free spin
- Durable, plastic rope

17207XXX	Orange 7' Licorice	\$3.99	EA
17208XXX	Red 8' Licorice	\$4.49	EA
17209XXX	Green 9' Licorice	\$4.99	EA
17210XXX	Black 10' Licorice	\$5.49	EA



LEATHER JUMP ROPE

- Ball bearing swivel and foam handles
- 9 1/2' long

2549XXXX	\$17.99	EA	★
----------	---------	----	---



HEAVYWEIGHT SASH ROPES

- Thick sash cord jointed into well shaped hollow handles

2546XXXX	8'	\$5.49	EA	★
2547XXXX	9 1/2'	\$6.99	EA	★
2548XXXX	16'	\$7.99	EA	★



WEIGHTED JUMP ROPES

- Durable with padded, swivel handles that allow rope to spin faster, reducing stress on wrists, elbows and shoulders
- 9' length

1024135	1 lb. - Red	\$29.99	EA	★
1024142	2 lb. - Blue	\$34.99	EA	★
1024159	3 lb. - Green	\$40.99	EA	★
1024166	4 lb. - Orange	\$49.99	EA	★



REACTOR CHAMPION BARBELL CABLE SPEED ROPE

- 10' L Low-kink PVC coated steel cable rope
- 6" L lightweight plastic ergonomic handles
- Double bearings in the handle with easy change length feature

1390925	\$19.99	EA	★
---------	---------	----	---



POWER SYSTEMS

FITNESS ROPE ANCHOR AND STORAGE HANGER

- Securely hold your training rope in place during workouts and storing when you are done
- Solid steel and powder coated construction
- Can be mounted to wall or floor with anchor bolts
- Mounting hardware not included
- Sold separately

1390927	Anchor - 10" H x 2.5" W x 4.5" D - 2 lbs.	\$29.99	EA
1395542	Hanger - 10" H x 2.5" W x 4.5" D - 2 lbs.	\$6.99	EA



REACTOR CHAMPION BARBELL

POWER ROPE ANCHOR STATION

- Use indoors or outside
- Accommodates up to 12 users at one time
- Solid rubber bottom for floor protection
- Add up to 4 - 45 lb. Olympic weight plates for maximum stability
- All welded, all silver powder coated steel construction
- 6.5" H x 23.5" W x 23.5" D - 32 lbs.

1375090	\$199.99	EA	★
---------	----------	----	---

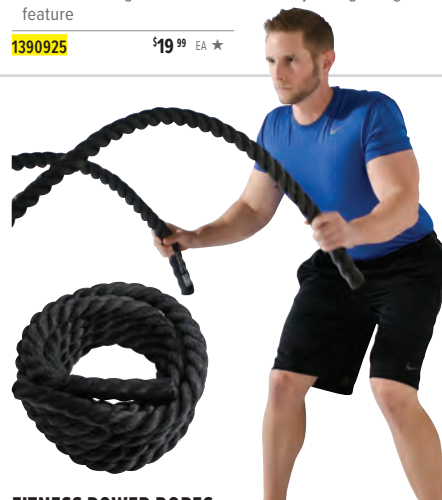

FITNESS POWER ROPES

- Various lengths and diameters to enhance the overall work-out experience
- Great for grip strength, stamina and overall conditioning
- Ideal for upper body and core exercises

1369620	1.5" D - 30' L	\$124.99	EA	★
1369621	1.5" D - 40' L	\$149.99	EA	★
1369622	1.5" D - 50' L	\$174.99	EA	★
1369624	2" D - 30' L	\$184.99	EA	★
1369625	2" D - 40' L	\$224.99	EA	★
1369626	2" D - 50' L	\$274.99	EA	★

Bid #ESC NJ 17/18-31

Educational Services Commission of New Jersey

Athletic Equipment & Supplies



REACTOR
CHAMPION BARBELL

QUICK RELEASE TETHER

- Combines fixed resistance with overload release for explosive speed training
- Partner-activated release frees tether from belt for a burst of speed
- Durable nylon mesh tether features reinforced stitching and a dual grip handles

1301793 \$49.99 EA



REACTOR
CHAMPION BARBELL

POWER DRIVER

- Connect together, back-to-back and attempt to pull the other while staying parallel to the ground
- Trains explosive position and allows hip flexors to fire at maximum velocity
- Includes two heavy-duty padded harnesses, a nylon mesh tether with reinforced stitching and easy-attach steel clips

1301861 \$79.99 EA



REACTOR
CHAMPION BARBELL

360° BELT SET

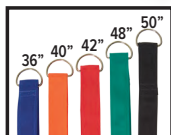

- Continuous belts without buckle closures allow heavy-duty steel rings full rotation without hindrance
- Use to increase first-step explosion, back pedaling speed and lateral quickness
- Includes 5 belts (color-coded by size), 8' long latex cord in nylon sheathing, and a safety cuff that tethers to the wrist

1301892 \$99.99 EA



REACTOR
CHAMPION BARBELL

DUAL RESISTANCE HARNESS

- One athlete provides resistance while the other runs
- Running positions can be alternated quickly for interval training
- Adjustable 3" waist belt
- Includes carry bag

1143591 \$54.99 EA ★



SKLZ
RECOIL 360

- Dynamic Resistance / Assistance Trainer
- Enhance strength & conditioning for sprinting, leaping, shuffling and change of direction.
- Work with a partner or attach the leash to a stationary object

1364670 \$64.99 EA



REACTOR
CHAMPION BARBELL

SPEED CHUTE

- Provides excellent resistance while running to improve speed, stamina, strength and acceleration
- Chute releases while running to provide resistance
- Includes carry bag

1143607 40" Diameter \$49.99 EA ★
 1143614 44" Diameter \$49.99 EA ★
 1273694 54" Diameter \$59.99 EA ★

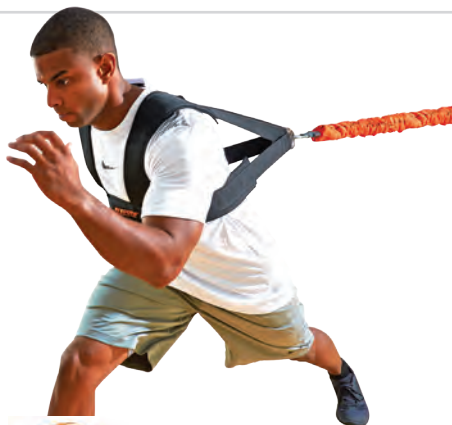

STROOPS
ACCELERATION TRAINERS

- Variable resistance develops explosive acceleration and strength
- 10' long oversized latex tubing anchors to a sturdy object for forward, backward and lateral speed training
- Sheathed in bunch free nylon that provides a built-in maximum stretch-limiter and protects against backlash in the event of a break
- Adjustable padded harness with 4 anchor rings

1382828 77 lbs. Resistance \$139.99 EA ★
 1301816 150 lbs. resistance \$234.99 EA ★



REACTOR
CHAMPION BARBELL

SHOULDER RESISTANCE HARNESS

- Strong harness for developing maximum stamina, strength, and power for running in proper form
- 10'L handled tether attaches to shoulder harness with adjustable waist belt

1143584 \$74.99 EA ★

Bid #ESCNJ 17/18-31



MONSTER TRAINING SLED

- Ideal for training runs or coach-assisted runs
- 37" W handle to accommodate wide and narrow grips as well as alternate grip positions
- Includes padded shoulder harness for comfort with strong nylon leads
- Two 12" weight posts hold up to 540 lbs. of Olympic style plates (sold separately)
- 32"W x 50"L x 2"H - 90 lbs.

1301687 **\$499⁹⁹** EA

Educational Services Commission of New Jersey

Athletic Equipment & Supplies

REACTOR
CHAMPION BARBELL

LOW PUSH/PULL TRAINING SLED

- Increase speed, explosion, leg strength and endurance
- Large radius handle allows for multiple grip locations
- 12"H x 2" O.D. post will hold up to 315 lbs. of Olympic plates (sold separately)
- One piece welded construction, 1.9" silver powder coated steel tubing
- Waist and shoulder harness is fully adjustable with quick release attachment and double safety tethers
- 14"H x 23"W x 38"L - 25 lbs

1375098	Sled and Harness	\$259⁹⁹ EA ★
1375084	Sled Only	\$219⁹⁹ EA ★
1240054	Harness and Tether Only	\$44⁹⁹ EA ★

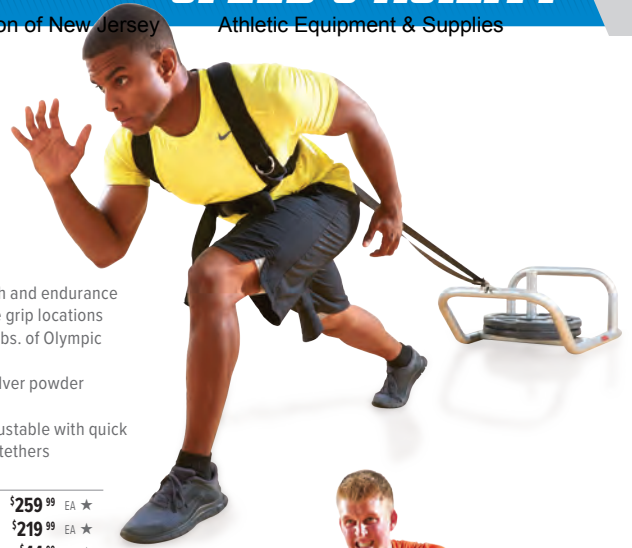
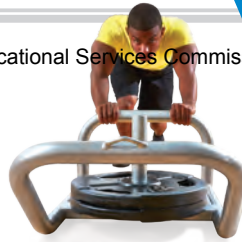

SPEED & AGILITY

SKLZ
SPEEDSAC

- Improves speed and explosiveness and strengthens lower-body muscle groups
- Includes 3 durable weight bags than can be filled with up to 10 lbs. of sand (30 lbs. total) for variable weight resistance
- Adjustable tether length to accommodate athletes of any size

1386494 **\$99⁹⁹** EA



REACTOR
CHAMPION BARBELL

BLASTER POWER SLED

- Increase speed, explosion, leg strength and endurance
- Made of 11 gauge durable black powder coated steel, skis are 1/4" solid steel
- Closed end rubber grips on low push handles, and capped large push handles accommodate standard 2" Olympic plates (sold separately)
- Optional waist and shoulder harness for pull attachment is fully adjustable with quick release attachment and double safety tethers
- 37"H x 46"W x 40"L - 60 lbs.

1377172	Sled Only	\$319⁹⁹ EA
1240054	Harness and Tether Only	\$44⁹⁹ EA ★



SKLZ
HOPZ VERTICAL JUMP TRAINER

- Develops explosive leg power and strengthens key muscles in the lower body to maximize vertical leap capability
- Quick and safe cable changes with patented, Slide-Lock™ system on ankle straps and belt
- Adjustable belt with side padding allows for proper band placement and fits most athletes
- Durable bands with resistance up to 80 lbs.
- Ankle straps with built-in show harness keeps resistance bands in place

1390929 **\$99⁹⁹** EA



PowerMax

PUSH/PULL SLED WITH HARNESS

- Push, pull or sprint your way to more power and speed
- 11 gauge steel frame with space saving design that is only 7" high when folded
- Replaceable/removable runners for use on a variety of surfaces
- Quick release pins for fast set up and breakdown
- Holds up to 300 lbs. of Olympic style weight plates (sold separately)
- 35"H x 24"W x 35"L - 45 lbs.

PMTA15504 Replacement Runners **\$35⁹⁹** EA





REACTOR
BY CHAMPION BARBELL
WEIGHT VEST

- Great for speed and power training
- Secure and comfort fitting straps for maximum movement of your arms, shoulders, and neck
- Adjustable from 1 lb. to 20 lbs. (weight packs included)

1369608 20 lbs. \$69⁹⁹ EA ★



X-FINITY WEIGHT VEST

- Comfortable form fitting ergonomic fitness vest
- Breathable design offers adjustable quick release chest buckle, reflective stripes (front and rear) and a secure pocket for your cell phone
- Do not machine wash or soak in water
- One size fits most

1395594 6 lb. - Grey \$49⁹⁹ EA ★
1395595 10 lb. - Black \$59⁹⁹ EA ★



VERSAFIT VEST

- Padded vest with adjustable hook and loop straps for a secure fit, one size fits most
- Each size comes with the corresponding number of 1 lb. removable sand filled weight bags
- Great for plyometric drills and bodyweight exercises

1388445 10 lbs. \$99⁹⁹ EA
1388446 20 lbs. \$119⁹⁹ EA
1388447 40 lbs. \$159⁹⁹ EA



REACTOR
BY CHAMPION BARBELL
LATERAL RESISTANCE TRAINER

- Designed to strengthen the muscles responsible for lateral movement, and designed to teach athletes proper technique
- Adjustable padded ankle cuffs provide a snug comfortable fit
- 17" flexi-cord, available in three resistance levels

1333879 Light \$29⁹⁹ EA
1333886 Medium \$29⁹⁹ EA
1333893 Heavy \$29⁹⁹ EA



SKLZ
LATERAL RESISTOR PRO

- Develops first step quickness and lateral speed
- Strengthens key muscles for fluid movement and proper body positioning
- Patented, Slide-Lock™ system for quick and safe resistance band changes
- Includes 3 different resistance bands: Light, Medium, Heavy
- Padded adjustable velcro ankle cuffs provide a comfortable fit for most athletes

1390928 \$39⁹⁹ EA



REFLEX BALL

- Bounces unpredictably when dropped to the ground
- Great for improving hand/eye coordination, balance, quickness and depth perception
- Use in virtually any open space with a flat surface
- Rubber ball - approximately 2.5" - 3" diameter
- Prism pack includes 1 of each color: Blue, Green, Orange, Purple, Red and Yellow

60500 Yellow \$11⁹⁹ EA ★

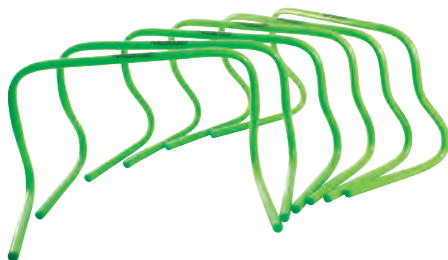

REACTOR
BY CHAMPION BARBELL
BANANA STEPS

- Molded tubular PVC construction
- Helps improve quickness and agility
- Designed to absorb impact or fall forward if struck, decreasing the likely hood of training related injuries
- 12"H x 17"W x 8"D
- Sold individually

1390931 \$8⁹⁹ EA ★



PORTaPiT
MULTI-HEIGHT FLEX HURDLE

- Lightweight multi-height flexible PVC hurdle can be converted into two heights 6" or 12" by folding legs in reverse directions
- Helps improve quickness and agility
- Hurdles can be positioned for plyometric jumps or running drills

1202076 \$49⁹⁹ SET OF 4 ★



SKLZ
6X HURDLE

- The all purpose hurdle for key performance drills
- Elegant, one piece twist design
- Bounce back construction is virtually indestructible

1386490 \$49⁹⁹ SET

Bid #ESCNJ 17/18-31

Educational Services Commission of New Jersey

Athletic Equipment & Supplies

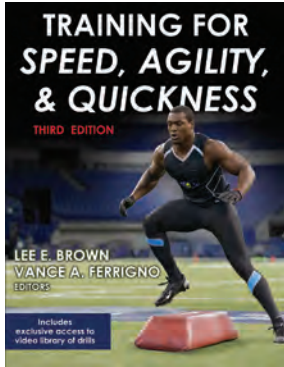

TRAINING FOR SPEED, AGILITY & QUICKNESS

- The ultimate training resource for improving speed, agility and quickness
- Includes exclusive online access to video library of drills which is ideal for both athletes and coaches
- Allows you to see exactly how to perform key tests and execute the best and most complex drills from the book

1248623 \$27⁹⁹ EA

INDOOR/OUTDOOR AGILITY POLE SYSTEM

- Train athletes to make sharp cuts, maintaining proper form, posture and position
- Reduce reaction time, while improving agility and speed on the field or in the gym
- Includes: (6) 2-piece, 60" PVC poles that break down for easy storage along with (6) spring-loaded spikes for outdoor use and (6) domed bases for drills indoors or on artificial turf
- Bases can be weighted with sand for extra stability

1248555 \$169⁹⁹ SET ★

QUICK THREADED CONNECTIONS



SAND WEIGHTED BASES



SAFETY SPIKE STORAGE



SPRING-LOADED OUTDOOR SPIKE



SPEED & AGILITY



REACTOR CHAMPION BARBELL AGILITY RINGS

- 12 - 19" diameter rings made of high impact PVC
- Make excellent targets for training sport-specific movements that require technical footwork
- Hook and loop tabs connect rings to create different movement patterns
- Includes carry bag

1375509 \$49⁹⁹ SET



SKLZ QUICK LADDER PRO 2.0

- No webbing means no tangling
- The ultimate in easy set-up, easy carrying training ladders
- Rigid hinged side rails make it easy to fold down
- Durable construction with professional grade materials
- 10'L x 15"W

1386489 \$59⁹⁹ EA



REACTOR CHAMPION BARBELL FIXED RUNG AGILITY LADDER

- Ideal for developing quick and accurate foot speed, increased balance and coordination
- Each ladder is 15'L x 20"W with ten sections
- Rugged 1" wide webbing with end buckles allow various shape configurations for a more diversified workout
- Connecting buckles allow for additional ladders for longer runs and different formations
- Includes carry bag

1248548 \$44⁹⁹ EA ★



SMART HURDLES

- The Smart Hurdle Sets are designed with athletes, coaches and PE teachers in mind and are versatile enough to handle your training needs from agility workouts to over/under drills
- Each hurdle features a sturdy 3-point base that improves stability on all surfaces
- Support leg rotates in either direction and folds flat for storage
- All sets include an easy to use transport handle

1379886	#1 6" - Set of 6	\$99 ⁹⁹ SET
1379887	#2 12" - Set of 6	\$104 ⁹⁹ SET
1379888	#3 12" - 18" - Set of 3	\$172 ⁹⁹ SET
1379889	#4 21" - 36" - Set of 3	\$210 ⁹⁹ SET
1379890	#5 27" - 42" - Set of 3	\$239 ⁹⁹ SET

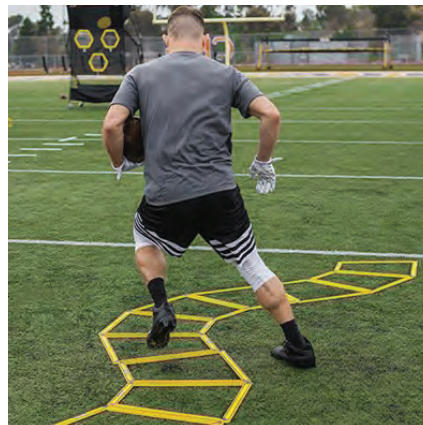

SKLZ AGILITY PRO TRAINER

- Train footwork and agility patterns in a game like situation
- Allows for Curvilinear and broken training patterns
- Durable enough to use on all surfaces, won't slip on hardwood or smooth surface
- Works on grass, turf, track and court

1395619 \$99⁹⁹ SET

REACTOR CHAMPION BARBELL DOT DRILL MAT

- Improve foot speed, reaction time and balance
- Perform multiple footwork patterns
- Cushioned foam rubber construction
- 48 1/2"L x 36"W x 1/2" thick

1301519 \$69⁹⁹ EA





POWER SYSTEMS

PRO POWER JUMPER

- Improve jump height and reaction time for better overall performance
- Unit includes resistance tubing, shoulder harness, 30" x 50" nonslip jumping platform
- Platform is counter weighted on each side with a 45 lb. weight plate (sold separately - see page 239)
- Standard length regular tubing for athletes 5'10" and under
- For indoor use only

1290875 **\$499⁹⁹** EA ★



THE TUG

- Use water for adjustable weight up to 140 lbs; provides a wide variety of activities including tug-of-war, weight training, use as a sled, as an anchor for sit-ups, overhead for lunges, and much more
- Water movement creates inertia that requires compensation for core body work
- 8"H x 30"W x 36"L - 15 lbs. empty
- Color options: Black, Green, Light Blue, Maroon, Orange, Purple, Red, Royal, Yellow

1301908 Specify Color **\$299⁹⁹** EA



VERSAFIT LOG

- Multiple handles and velcro straps allow you to vary exercise focus and function by gripping the bag in different ways
- Use for balance, plyometrics, rotational movements, Olympic lifts, chops and throws
- 23"L x 8" diameter

1301618	10 lb.	\$144⁹⁹ EA
1301625	20 lb.	\$154⁹⁹ EA
1301632	30 lb.	\$164⁹⁹ EA
1301649	40 lb.	\$174⁹⁹ EA
1301656	50 lb.	\$184⁹⁹ EA



PowerMax FUNCTIONAL FITNESS SAND BAG

- Built from durable woven nylon fabric and double sealed to hold inner sand bags securely
- Five padded handles are strategically placed for multiple movement planes and versatility
- Includes 4 sand bag inserts that can hold up to 20 lbs. each
- Sand not included

PMTA12241 **\$139⁹⁹** EA



SKLZ SUPER SAND BAG

- Heavy Duty Training Bag
- Increase power & explosiveness
- Great for building total body strength
- includes 4 sand bag inserts that can each hold up to 10 lbs.

1364674 **\$79⁹⁹** EA

EKHO™ HEART RATE MONITOR SYSTEMS

ASSESSMENT



E-15

- Includes chest belt transmitter
- Functions include: Current heart rate, Avg. heart rate, Max. heart rate, Target zone, Out of zone audible & visual alarm, Calories burned, Date and Time, Stopwatch, Large LCD, ECG Accurate

5 Year Limited Warranty

1137484 \$79⁹⁵ EA ★
 1377225 Class Pack w/Aluminum Case \$2,199⁹⁵ PACK OF 30 ★

E-10

- Includes chest belt transmitter
- Functions include: Current heart rate, Date and Time, ECG accurate, Large display, Water resistant, User changeable batteries

5 Year Limited Warranty

1137477 \$59⁹⁵ EA ★
 1377224 Class Pack w/Aluminum Case \$1,699⁹⁵ PACK OF 30 ★

WMP-89

- Strapless! - Transmitter belt not required
- Functions include: Current and average heart rate, percentage of max heart rate and max heart rate during exercise, calorie counter and total fat burn, date and time, lap memory, stop watch, large display with backlight
- Meets NASPE Standards

5 Year Limited Warranty

1388588 \$69⁹⁵ EA ★
 1388589 Class Pack w/Aluminum Case \$1,849⁹⁵ PACK OF 30 ★

POLAR®



FT1 HEART RATE MONITOR

Polar FT1 is for simple heart rate training with instant feedback on intensity and calories.

- Shows heart rate on a large easy-to-read display
- Helps improve fitness with manual target zones
- Students can safely exercise within their target zone
- Suitable for swimming
- Includes coded T31C transmitter and elastic strap to be worn around the chest

1307146 Heart Rate Monitor \$59⁹⁹ EA



NEW!

M200 WRIST BASED HEART RATE & GPS

Polar M200 is a waterproof running watch with wrist-based heart rate, integrated GPS and 24/7 activity tracking.

- Optical Heart Rate - Continuous, accurate heart rate without a chest strap
- Broadcast Heart Rate - The M200 can be used as a HR sensor. Seamless connection to your iPad and Polar GoFit App
- Integrated GPS - Speed, distance and route tracking
- Polar Flow App - Track your training and activity, analyze your progress and achieve more with Polar Flow

Color Options: **Black, Red**

1399697 Specify Color \$169⁹⁹ EA



NEW!

M430 WRIST BASED HEART RATE & GPS

Polar M430 integrates state-of-the-art running metrics and advanced GPS with the freedom of optical heart rate technology.

- Optical Heart Rate - Proprietary heart rate algorithm and 6 LED optical sensors built into the wrist based heart rate monitor - no chest strap required
- Integrated GPS - The latest in GPS and accelerometer technology to track your speed, distance and pace
- Activity Monitoring - Records your steps, distance, calories burned, and sleep
- Polar Flow App - Track your training and activity, analyze your progress and achieve more with Polar Flow

1399700 Specify Color \$279⁹⁹ EA

BEE-FIT PEDOMETERS

WORKER BEE YELLOW

- Meets NASPE Standards
- Features include: counts steps, extra large digital display, durable construction with hinged cover, loss prevention strap, spring loaded alligator clip and user changeable batteries
- Worker Bee includes distance, activity time and calories
- Class Packs include 32 unit carrying case

5 Year Limited Warranty

1216769	Worker Bee Yellow	\$17 ⁹⁵ EA ★
1309140	Worker Bee Prism Pack	\$99 ⁹⁵ PACK OF 6 ★
1377236	Worker Bee Class Pack of 32	\$499 ⁹⁵ PACK OF 32 ★
1376373	Busy Bee Yellow	\$15 ⁹⁵ EA ★
1377237	Busy Bee Class Pack of 32	\$469 ⁹⁵ PACK OF 32 ★

WORKER BEE PRISM PACK

- Meets NASPE Standards
- Features include: counts steps, extra large digital display, durable construction with hinged cover, loss prevention strap, spring loaded alligator clip and user changeable batteries
- Worker Bee includes distance, activity time and calories
- Includes 1 each: Blue, Green, Orange, Purple, Red and Yellow

5 Year Limited Warranty

1309140	Set of 6	\$99 ⁹⁵ PACK ★
---------	----------	---------------------------



E-Z ACCESS PEDOMETER STORAGE POCKETS

- Heavy-duty storage system allows students access their pedometers quickly and easily
- Teachers can assign pedometers by number and check inventory instantly
- Durable polyester system features 72 transparent PVC pockets (3 3/4" square) with brass grommets for hanging.
- Pedometers sold separately

1273526 39"H x 31 1/2"W \$54⁹⁹ EA ★



PEDOMETER/ACCELEROMETER STORAGE CASE

- Clear plastic storage case
- Holds up to 32 pedometers

1376395 \$9⁹⁵ EA ★

SPORTLINE®

330DS ELECTRONIC PEDOMETER

- Just clip it on and go
- Counts to 1 million steps
- Single axis technology
- Auto-stride length setting
- Single button operation



1369651 \$15⁹⁹ EA

330 ELECTRONIC PEDOMETER

- Ideal for 10,000 steps/day programs
- No adjustment - ready to use
- Large, easy to read display
- Spring loaded belt clip
- Easy reset button
- Battery (LR1142) included



1237832 \$13⁹⁹ EA



PEDOMETERS & ACCELEROMETERS

ASSESSMENT



ONE.5

- No moving parts = no clicking sound
- Tests more accurate than spring-levered and spring-activated pedometers
- Keeps its accuracy even when tilted
- User-friendly and offers greater motivation and goal setting tools for every walker
- Includes: steps, piezoelectric motor, clam shell, alligator clip, loss prevention strap and user changeable battery
- Class Pack option includes: 32 Accelerometers and 32 unit capacity carrying case

5 Year Limited Warranty

1376380 \$19⁹⁵ EA ★
 1377241 \$579⁹⁵ PACK OF 32 ★

Class Pack



ONE

- Perfect for your 10,000 step per day program.
- Includes: step counter w/extra large digital display, hinged protective cover, loss prevention strap, spring-loaded alligator clip and user changeable battery
- Class Pack option includes: 32 Pedometers, 32 loss prevention straps and 32 unit capacity carrying case

5 Year Limited Warranty

1277210 \$15⁹⁵ EA ★
 1377238 \$469⁹⁵ PACK OF 32 ★

One Class Pack of 32



TWO

- All of the same specifications as the Ekho "One" plus tracks steps and multiplies them by stride length to calculate distance traveled
- Class Pack option includes: 32 Pedometers, 32 loss prevention straps and 32 unit capacity carrying case

5 Year Limited Warranty

1277227 \$16⁹⁵ EA ★
 1377239 \$499⁹⁵ PACK OF 32 ★

Two Class Pack of 32



THREE

- Same specifications as the Ekho "One" and "Two" plus how long it took to get "there" and how many calories burned during your journey
- Class Pack option includes: 32 Pedometers, 32 loss prevention straps and 32 unit capacity carrying case

5 Year Limited Warranty

1277234 \$18⁹⁵ EA ★
 1377240 \$529⁹⁵ PACK OF 32 ★

Three Class Pack of 32



MVPA ACCELEROMETER

- No moving parts = no clicking sound
- Tests more accurate than spring-levered and spring-activated pedometers
- Keeps its accuracy even when tilted
- User-friendly and offers greater motivation and goal setting tools for every walker
- Includes: steps, distance, calories, exercise time, MVPA, clock, speed, 7-days memory, piezoelectric motor, clam shell, alligator clip, loss prevention strap, user changeable battery and automatic shut-off when inactive to save battery life

5 Year Limited Warranty

1376383 \$29⁹⁵ EA ★
 1377244 \$899⁹⁵ PACK OF 32 ★

Class Pack



NEW!
FLEXIBILITY ASSESSMENT TESTER

- Durable, powder coated steel construction with non-skid, non marring base
- For use with The Presidential Physical Fitness Test, Fitnessgram™, SHAPE, Cooper Institute and YMCA programs
- Foot plates fold flat for easy storage and transport
- Smooth glide reach indicators with easy to read English and Metric calibration
- NO assembly required

1378689 Single – 26" L x 15" W x 12.5" H \$109⁹⁹ EA ★
1378691 Double – 38" L x 15" W x 12.5" H \$169⁹⁹ EA ★



BASELINE

1. BASELINE FLEX TESTER - STANDARD

- Provides the most popular sit and reach test
- Scales printed in inches and centimeters
- For use with any fitness program measuring flexibility including The Presidential Physical Fitness Test, Fitnessgram™, Cooper Institute, YMCA and SHAPE
- Sturdy construction with built-in footplate and maximum stretch indicator that remains until reset
- Assembly required

1375499 \$165⁹⁹ EA

2. BASELINE FLEX TESTER - DELUXE

Deluxe model offers the same benefits as the Standard model plus the following additional features:

- Used for modified sit-and-reach test enabling the testing protocols to be used that vary the scale starting point
- Adjustable tension reach indicator allows for variations in the length of arms and legs of the person being tested

1375500 \$249⁹⁹ EA



US GAMES PUSH-UP CHALLENGER

- Provides the teacher and student an effective way to test each individual push up fairly and consistently, while teaching the proper mechanics of the push up
- The student simply touches their chin to the PUSH-UP CHALLENGER, almost guaranteeing their arms are at a right angle
- The push-up tester is now being used by many for Presidential and Fitnessgram tests
- Stackable for easy storage

1377081 \$163⁹⁹ DZN ★



VERTICAL JUMP CHALLENGER

- Telescopes from 4 to 12 feet
- Heavy duty base and casters for stability and portability
- Moveable metal arms placed at 1" increments
- Highest arm reached remains angled until jump reading is measured
- Includes handy reset pole
- Weight plates not included

1245448 \$439⁹⁹ EA



BASELINE

STADI-O-METER

- Lightweight and portable wall mount height measurement rod
- Measures from 30" to 84"
- Easy-slide flip-down measuring arm with analog reading
- Durable steel construction, installs in minutes

1375498 \$119⁹⁹ EA



CARPETED LONG JUMP MAT

- Carpet on top and a non-slip bottom
- Measures long jump distance

1268928 \$78⁹⁹ EA ★
Carpet size - 12' L x 30" W

MAGNETIC JUMP & REACH BOARD

- Includes two magnets which are placed on board at peak of jump
- Graduations are silk screened on board in 1/2" increments
- Wall mounting hardware not included

6002DXXX \$73⁹⁹ EA ★



Bid #ESCNJ 17/18-31

Educational Services Commission of New Jersey

Athletic Equipment & Supplies

BASELINE

ECONOMY BODY FAT MONITOR

- Measures Body Fat and Hydration Percentages!
- Measures 4% - 45% body fat and 37.8% - 66% body water with .1% resolution
 - 8 person memory
 - Adult and child user modes
 - Displays in Lbs. or Kgs.
 - Includes 2 x 3.0V lithium batteries

1249866

\$26⁹⁹ EA



ASSESSMENT



NEW!

BASELINE WALL GROWTH CHART

- Measurement range is 0-78 in (0-198 cm)
- Measures height easily and quickly
- Blue text over white background
- Wide margins allow for notes - 3.5 in wide
- 1-mil polyester laminated covering with protective topcoat
- Reads vertically upward
- Adhesive backing

1397714

\$29⁹⁹ EA

INSTA PULSE HEART RATE MONITOR

- Unique "Baton" style pulse monitor bar allows an entire class to check pulse rate in a short period of time
- Simply grasp bar, read pulse and pass the baton to the next person
- Standard 9V Battery included
- Waterproof

2217

Monitor Bar Only

\$169⁹⁹ EA

SLIM GUIDE SKINFOLD CALIPER

- Only low-cost caliper which meets all of the requirements for jaw pressure and accuracy
- It meets or exceeds specs of the Harpenden and Skyndex units for a fraction of the cost
- Includes instruction booklet



6575XXXX

NJ State Approved Co-op #65MCECCPS Metuchen/Garden State AppareBid Term: 5/9/18 - 5/8/20: Extended to 5/8/21

\$25⁹⁹ EA



WRIST BLOOD PRESSURE MONITOR

- Clinically Proven Accuracy with Smart Measure™ Technology
- One-touch operation for easy use
- Risk Category Index
- 120 Memories / 2 Users
- Date and time stamp
- Memory averaging function
- Batteries and protective plastic storage case are included
- 5 year warranty

1299342

\$54⁹⁹ EA

BASELINE BODY FAT/HYDRATION & SCALE

- Measures weight, body fat and water percentage
- 4% - 45% body fat and 37.8% - 66% body water ranges
- 8-person memory
- 330 lbs. maximum capacity
- Adult and child modes
- Requires 9V alkaline battery



1375488

\$52⁹⁹ EA

CANDO

CANDO[®] PEDAL EXERCISER

- A deluxe digital, portable exerciser for both the upper and lower body
- LCD display tracks speed, distance, time, calories burned and more
- Use on the floor for foot pedaling or on a tabletop for hand pedaling
- Wide frame and non-marring feet keeps the exerciser stable
- Includes an adjustable tension knob
- Requires 2 AA batteries included - 11" x 17" x 22"



1384928

\$132⁹⁹ EA

BEFOUR PS-6600ST PORTABLE SCALE

- Compact, portable and battery operated
- Quick and accurate +/- 0.1 lb
- 16" x 18" x 1-3/4" platform
- 500 lb. weight capacity; weighs in lbs or kg
- Plug & Weigh with auto-zero and 4-minute auto-off function
- Super Tuff one-piece cast aluminum construction
- Dual power via rechargeable batteries or AC plug-in adapter
- Made in the U.S.A.



1384368

Scale & Console

\$739⁹⁹ EA

1384376

Hard-Shell Carry Case

\$299⁹⁹ EA

1384377

Soft-Sided Carry Case

\$99⁹⁹ EA

OMRON

BODY COMPOSITION MONITOR & SCALE

- Full Body Sensing provides an accurate comprehensive understanding of your body composition to help you reach your fitness goals
- Measures 7 Fitness Indicators: Body Fat Percentage, Body Mass Index (BMI), Skeletal Muscle, Resting Metabolism, Visceral Fat, Body Age and Body Weight
- 330 lb. capacity
- 4 Person Profile, 90/180 Day Memory, Large LCD display
- 4 "AA" batteries included



1277722

HBF-516B

\$145⁹⁹ EA

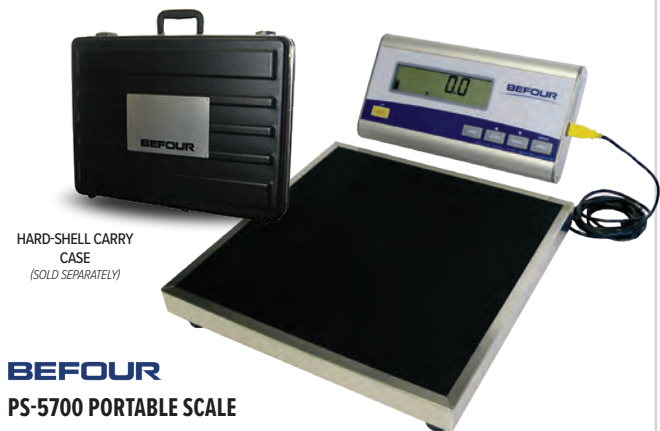

HARD-SHELL CARRY CASE
(SOLD SEPARATELY)

BEFOUR PS-5700 PORTABLE SCALE

- Compact, portable and battery operated
- 13" x 13" x 2" platform
- 500 lb. weight capacity; weights in lbs or kg
- Programmable settings include auto-off time, always-on option, audible beep
- Plug & Weigh with weight recall and reweigh functions
- MotionLock Technology accurately weighs unsteady users
- Durable all-metal construction; uses 6 C-cell batteries
- Made in the U.S.A.

1384366

Scale & Console

\$749⁹⁹ EA

1384378

Hard-Shell Carry Case

\$299⁹⁹ EA

1384377

Soft-Sided Carry Case

\$99⁹⁹ EA

BEFOUR PS-6700 PORTABLE SCALE

- Compact, portable and battery operated scale
- Quick and accurate +/- 0.1 lb
- 16" x 18" x 1-3/4" platform
- 500 lb. weight capacity
- Programmable settings include auto-off time, always-on option, audible beep
- Weighs in pounds or kilograms
- Plug & Weigh with weight recall and reweigh functions
- MotionLock Technology accurately weighs unsteady users
- Push button calibration
- 1" LCD easy to read digits
- Durable all-metal construction
- Uses 6 C-cell batteries
- Soft-sided or Hard-shell carry case available
- Made in the U.S.A.



SOFT-SIDED CARRY CASE
(SOLD SEPARATELY)

1384367

Scale & Console

\$769⁹⁹ EA

1384378

Hard-Shell Carry Case

\$299⁹⁹ EA

1384377

Soft-Sided Carry Case

\$99⁹⁹ EA



DETECTO

A Division of Cardinal Scale Manufacturing Co.



ASSESSMENT



SOLO SCALE & HEIGHT ROD

- Wide platform with low profile for easy access
- Platform dimensions: 14"W x 15"D x 2.5"H
- 550 lb capacity with BMI calculation
- Easy to read LCD display; Includes 6 AA batteries
- Wheels for easy transport
- Inline height rod measures up to 7'

2 Year Limited Warranty

1393358 \$499⁹⁹ EA
 1335828 9V AC/DC Adapter \$78⁹⁹ EA



PHYSICIAN'S SCALE

- Features a height rod in inches and centimeters, from 30" to 78" (76cm to 198cm).
- Platform cover is easily removed for cleaning.
- Die-cast beam can be easily read from either side.
- 400 lb. capacity.
- Heavy duty understructure.
- Every Detecto physician scale features a time-honored reputation for rigid construction and precision engineering.

2 Year Limited Warranty

1077858 #439 \$329⁹⁹ EA



SLIMPRO LOW-PROFILE DIGITAL SCALE

- Digital 1.4" high low-profile scale with 17" x 14.5" platform
- LCD Screen with large 1.5" high digits and 5-second weight hold
- 440-lb capacity with accuracy of 0.2 lbs
- Built-in carrying handle for portability
- Foot pads for weighing on any surface (even carpets)
- 4 AAA batteries (included) with auto On/Off
- RS232 serial port for use with optional P50 thermal tape printer or EMR/EHR software

2 Year Limited Warranty

1384312 \$154⁹⁹ EA



PORTABLE FLOOR SCALE

- Low profile design, heavy duty mechanical construction and a non-skid vinyl mat
- The large diameter dial allows for easy readability even for tall people
- Designed for personal use, fitness centers, and health care facilities
- 300 lb. capacity
- Overall dimensions: 2.5"H x 12"W x 16.75"D - 9 lbs.
- Platform dimensions: 11.25"W x 11.75"D

1292725 D1130 \$94⁹⁹ EA



PRO DOC DIGITAL SCALE

- Weighs up to 480 lbs
- Easy-to-view LCD display with 1" high digits
- Adjustable locking feet and bubble level
- Selectable sleep and auto shut-off mode
- Comes with a wall/desk mounting bracket and is portable with optional carrying case
- Powered by 6 "AA" batteries (not included) or by 9V AC/DC Power Adapter (sold separately)

2 Year Limited Warranty

1298710 PD100 - Without Display Stand \$499⁹⁹ EA
 1335828 9V AC/DC Adapter \$78⁹⁹ EA



BONDED-FOAM MATS

Firmer Than Polyfoam Mats, But Softer Than Polyethylene Mats!

- Perfect for tumbling, exercise, play and low impact gymnastics by elementary and middle school age children
- Top quality 2" thick bonded foam mat designed for comfort and moderate support
- Nylon reinforced tough 18 oz. vinyl cover uses double reinforced, nylon stitched inverted seams to create a smooth working surface
- Mats have 2' panels and folds



4' X 8' MAT SHOWN
Specify Color(s) when ordering!

CODE	MAT SIZE	PANEL SIZE	HOOK & LOOP FASTENER OPTIONS			ROYAL MATS	COLOR MATS	DELIVERY
			NONE	ENDS ONLY	ALL SIDES	PRICE	PRICE	
1280876	4' x 6'	2'	X			\$216 ⁹⁹	\$216 ⁹⁹	
1280807	4' x 8'	2'	X			\$224 ⁹⁹ ★	\$260 ⁹⁹ ★	
1280814	5' x 10'	2'	X			\$326 ⁹⁹ ★	\$367 ⁹⁹ ★	
1280821	6' x 12'	2'	X			\$530 ⁹⁹ ★	\$581 ⁹⁹ ★	
1044218	4' x 6'	2'		X		\$214 ⁹⁹ ★	\$238 ⁹⁹ ★	
1041903	4' x 8'	2'		X		\$275 ⁹⁹ ★	\$314 ⁹⁹ ★	
1041927	5' x 10'	2'		X		\$418 ⁹⁹ ★	\$465 ⁹⁹ ★	
1041941	6' x 12'	2'		X		\$571 ⁹⁹ ★	\$612 ⁹⁹ ★	
1044225	4' x 6'	2'			X	\$234 ⁹⁹ ★	\$270 ⁹⁹ ★	
1041484	4' x 8'	2'			X	\$295 ⁹⁹ ★	\$335 ⁹⁹ ★	
1041507	5' x 10'	2'			X	\$428 ⁹⁹ ★	\$476 ⁹⁹ ★	
1041521	6' x 12'	2'			X	\$591 ⁹⁹ ★	\$632 ⁹⁹ ★	

WHICH MAT IS RIGHT FOR YOU?

SOFT

2" POLYFOAM

- SOFT
- LOW ABSORPTION
- LOW-IMPACT ACTIVITIES WITH **VERY** YOUNG CHILDREN



FIRM

2" BONDED FOAM

- SEMI-FIRM
- MEDIUM ABSORPTION
- MEDIUM-IMPACT ACTIVITIES OLDER CHILDREN. PERFECT FOR TUMBLING / LOW-IMPACT GYMNASTICS.



2 3/8" COMBO FOAM

- SEMI-SOFT
- MEDIUM ABSORPTION
- MEDIUM-IMPACT ACTIVITIES WITH YOUNG CHILDREN

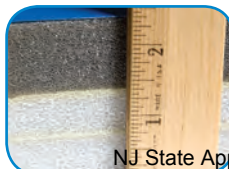

1 3/8" POLYETHYLENE

- FIRM
- HIGH ABSORPTION
- HIGH-IMPACT ACTIVITIES BY OLDER CHILDREN AND HEAVIER USERS. USED IN PE / GYMNASTICS CLASSES, CHEERLEADING AND MARTIAL ARTS TRAINING.





ULTIMAT®

Our Firmest and Lightest Mat!

- Provides firm support for high impact activities
- Use in physical education and gymnastic classes, cheerleading and martial arts training and more
- 1 3/8" firm cross-linked foam covered in tough 18 oz. vinyl
- Cover resists abrasions, tears, fungus and mildew
- Mats have 2' panels and folds



WALL MOLDING STRIPS

- Attach permanently to wall for hanging mats with fasteners on 4 sides
- 1 5/8" wide hook and loop fastener strip holds mats to wall
- Sold in 6' sections

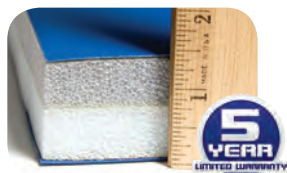

**1 3/8" CROSS LINKED
POLYETHYLENE FOAM**

1044782

Specify Hook or Loop Fasteners

\$61⁹⁹ SET



5' X 10' MAT SHOWN
Specify Color(s) when ordering!

CODE	MAT SIZE	HOOK & LOOP FASTENER OPTIONS			ROYAL MATS	COLOR MATS	DELIVERY
		NONE	ENDS ONLY	ALL SIDES	PRICE	PRICE	
1280838	4' x 6'	X			\$193 ⁹⁹ ★	\$224 ⁹⁹ ★	
1280845	4' x 8'	X			\$244 ⁹⁹ ★	\$281 ⁹⁹ ★	
1280852	5' x 10'	X			\$377 ⁹⁹ ★	\$422 ⁹⁹ ★	
1280869	6' x 12'	X			\$489 ⁹⁹ ★	\$540 ⁹⁹ ★	
1257915	4' x 6'		X		\$214 ⁹⁹ ★	\$238 ⁹⁹ ★	
1041880	4' x 8'		X		\$265 ⁹⁹ ★	\$303 ⁹⁹ ★	
1041965	5' x 10'		X		\$397 ⁹⁹ ★	\$443 ⁹⁹ ★	
1041989	6' x 12'		X		\$499 ⁹⁹ ★	\$551 ⁹⁹ ★	
1257922	4' x 6'			X	\$224 ⁹⁹ ★	\$260 ⁹⁹ ★	
1041545	4' x 8'			X	\$275 ⁹⁹ ★	\$314 ⁹⁹ ★	
1041569	5' x 10'			X	\$408 ⁹⁹ ★	\$455 ⁹⁹ ★	
1041583	6' x 12'			X	\$510 ⁹⁹ ★	\$561 ⁹⁹ ★	

COLOR CHOICES: Choose from 14 school colors, in solids or alternating panel colors.
Due to dye lots and natural variations, vinyl colors may vary slightly if ordered at separate times.

Black Columbia Dark Green Grey Kelly Maroon Navy Orange Purple Red Royal Tan White Yellow

NJ State Approved Co-op #65MCESCPS Metuchen/Garden State AppareBid Term: 5/9/18 - 5/8/20; Extended to 5/8/21



EXPANDO SUPERNOVA MATS

Our Softest Mat for Low Impact Activities With Very Young Users!

- For teaching basic gymnastics & exercises to children ages 3-9
- So light young children can move and store them
- Nylon reinforced tough 18 oz. vinyl cover uses double reinforced, nylon stitched inverted seams to create a smooth working surface
- Mats have 2' panels and folds
- **Fasteners on Ends Only**



CODE	SIZE	ROYAL MATS	COLOR MATS	DELIVERY
		PRICE	PRICE	
1058277	4' x 6'	\$234 ⁹⁹ ★	\$265 ⁹⁹ ★	
1051476	4' x 8'	\$275 ⁹⁹ ★	\$306 ⁹⁹ ★	
1051483	5' x 10'	\$428 ⁹⁹ ★	\$469 ⁹⁹ ★	
1051490	6' x 12'	\$561 ⁹⁹ ★	\$602 ⁹⁹ ★	

4' X 8' MAT SHOWN

Specify Color(s) when ordering!



2" 100 ILD POLYFOAM



RAINBOW MATS

One Foot Panels and 18 oz. Vinyl!

- Available with your choice of 1 3/8" cross-linked polyethylene (firmer for high impact activities) and 2" polyfoam fillers (softer for young users and low impact activities)
- Each 1' panel is covered with a different color of nylon reinforced 18 oz. vinyl
- Mats have 1' panels and 2' folds
- 1' panel mats lie flatter than 2' panel mats
- **Fasteners on Ends Only**

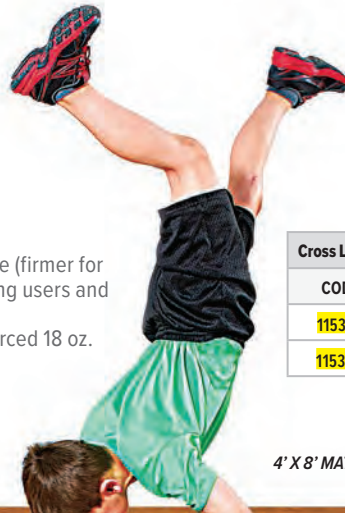

4' X 8' MAT SHOWN

Cross Linked Polyethylene Foam				
CODE	MAT SIZE	PANEL SIZE	PRICE	DELIVERY
1153521	4' x 6'	1'	\$204 ⁹⁹ ★	
1153538	4' x 8'	1'	\$255 ⁹⁹ ★	



COLOR CHOICES: Choose from 14 school colors, in solids or alternating panel colors. Due to dye lots and natural variations, vinyl colors may vary slightly if ordered at separate times.

1 3/8" CROSS LINKED POLYETHYLENE FOAM

2" POLYFOAM

Black

NJ State Approved Co-op #65MCECCPS Metuchen/Garden State AppareBid Term: 5/9/18 - 5/8/20: Extended to 5/8/21

Columbia

Dark Green

Grey

Kelly

Maroon

Navy





EXPANDO NOVA DUO LAYERED-FOAM MATS

Combines the Soft Cushion of Polyfoam with the Firm "no bottoming" Trait of Polyethylene!

- Perfect for young, beginner or intermediate tumblers
- A 1" layer of polyfoam provides the softness for younger, lightweight children, while a firmer 1 3/8" polyethylene layer keeps the mat from "bottoming out" during more extensive use
- Nylon reinforced tough 18 oz. vinyl cover uses double reinforced, nylon stitched inverted seams to create a smooth working surface
- Mats have 2' panels and folds and are lightweight for easy handling and storage
- Fasteners on ends only



**1" POLYFOAM LAYER
A FIRMER 1 3/8"
POLYETHYLENE LAYER**



CODE	MAT SIZE	ROYAL MATS	COLOR MATS	DELIVERY
		PRICE	PRICE	
1044256	4' x 6'	\$275 ⁹⁹ ★	\$306 ⁹⁹ ★	
1041781	4' x 8'	\$346 ⁹⁹ ★	\$387 ⁹⁹ ★	
1041828	5' x 10'	\$520 ⁹⁹ ★	\$571 ⁹⁹ ★	
1041842	6' x 12'	\$632 ⁹⁹ ★	\$683 ⁹⁹ ★	



MAT TAPE

- Easy to use and remove
- Will not stretch out
- Secures overlaps

6411XXXX	3" x 84'	\$14 ⁴⁹ ROLL ★
6406XXXX	4" x 84'	\$15 ⁴⁹ ROLL ★



MAT CART

- A durable, PVC mat truck transports and stores mats of all sizes
- Lightweight cart is easily maneuvered by one person
- The convenient handle folds flat for easy storage
- Some assembly required

1246155	7"H x 22"W x 66"L	\$229 ⁹⁹ EA
---------	-------------------	------------------------



EXPANDO MAT TRUCK

- Transport your folding and non-folding mats up to 6' x 12'
- Features a galvanized steel tube frame with plywood base covered in carpet
- The large handle and 4 swivel casters makes it easy to maneuver

MTTRUCK	2'W x 6'L	\$459 ⁹⁹ EA	
---------	-----------	------------------------	--



WHIZZER®

- Multipurpose concentrate kills HIV-1 (AIDS virus), MRSA, Hepatitis B & C, and other viruses. Kills strep, staph and fungus germs on contact.
- Cleaner, fungicide, mildewstat, virucide and deodorizer - all in one. Comes complete with 2 FREE Pint spray bottles.
- Economical. One ounce of concentrate mixed with water makes a gallon of full-strength disinfectant. 128 dilutions per gallon.
- Fast. Apply directly to mats, floors, walls, training tables, locker rooms, or personal items. Just wipe dry.



1155235	1 Gallon + 2 FREE Pint Spray Bottles	\$64 ⁹⁹ EA
---------	--------------------------------------	-----------------------



**MATT-KLEEN™ ALL PURPOSE
DISINFECTANT CLEANER**

- Helps stop the spread of skin diseases and infections
- Ideal for wrestling and gymnastic mats, training tables and shower floors
- Highly concentrated; 2 oz. makes one full gallon



1092479	Gallon	\$79 ⁹⁹ EA
---------	--------	-----------------------

NJ State Approved Co-op #65MCESCCPS Metuchen/Garden State AppareBid Term: 5/9/18 - 5/8/20: Extended to 5/8/21

Orange Purple Red Royal Tan White Yellow

MATS



- New GREEN patented foam product
- Made from 60% recycled and 40% virgin polyester fiber
- Safer for environment than other foams
- 100% toxin and latex free
- Mold and mildew proof
- 18 oz. PVC coated vinyl covering
 - Fire retardant California 117 T.B.
- 2' panels and 2' folds

ADVANTAGES

FEATURE	ENVIROSAFE	URETHANE/POLY FOAMS
100% Toxin Free	YES	NO
Zero VOC's or Off Gas	YES	NO
Hypoallergenic	YES	NO
Latex Free	YES	NO
Fire Retardant Calif 117T.B.	YES	NO
Mold & Mildew Proof	YES	NO
100% Recyclable	YES	NO
No Leachable Chemicals	YES	NO



4 FOAM CHOICES



EXCELLENT CUSHION RESISTANCE!

1 1/2" THICK EXTRA FIRM

Fasteners On Ends Only

1289275	4' x 6' x 1 1/2"	\$249 ⁹⁹ EA
1289558	4' x 8' x 1 1/2"	\$313 ⁹⁹ EA
1289831	5' x 10' x 1 1/2"	\$469 ⁹⁹ EA
1290110	6' x 12' x 1 1/2"	\$619 ⁹⁹ EA

2" THICK SOFT ILD 100

Fasteners On Ends Only

1287035	4' x 6' x 2"	\$244 ⁹⁹ EA
1287318	4' x 8' x 2"	\$306 ⁹⁹ EA
1287592	5' x 10' x 2"	\$469 ⁹⁹ EA
1287875	6' x 12' x 2"	\$625 ⁹⁹ EA

2" MEDIUM FIRM

Fasteners On Ends Only

1288155	4' x 6' x 2"	\$234 ⁹⁹ EA
1288438	4' x 8' x 2"	\$295 ⁹⁹ EA
1288711	5' x 10' x 2"	\$448 ⁹⁹ EA
1288995	6' x 12' x 2"	\$625 ⁹⁹ EA

2 1/2" THICK EXTRA FIRM/SOFT COMBO

Fasteners On Ends Only

1285710	4' x 6' x 2 1/2"	\$326 ⁹⁹ EA
1285994	4' x 8' x 2 1/2"	\$397 ⁹⁹ EA
1286274	5' x 10' x 2 1/2"	\$561 ⁹⁹ EA
1286557	6' x 12' x 2 1/2"	\$719 ⁹⁹ EA

1 1/2" THICK EXTRA FIRM

Fasteners On All 4 Sides

1289411	4' x 6' x 1 1/2"	\$271 ⁹⁹ EA
1289658	4' x 8' x 1 1/2"	\$343 ⁹⁹ EA
1289978	5' x 10' x 1 1/2"	\$520 ⁹⁹ EA
1290257	6' x 12' x 1 1/2"	\$666 ⁹⁹ EA

2" THICK SOFT ILD 100

Fasteners On All 4 Sides

1287172	4' x 6' x 2"	\$275 ⁹⁹ EA
1287455	4' x 8' x 2"	\$343 ⁹⁹ EA
1287738	5' x 10' x 2"	\$499 ⁹⁹ EA
1288018	6' x 12' x 2"	\$666 ⁹⁹ EA

2" MEDIUM FIRM

Fasteners On All 4 Sides

1288292	4' x 6' x 2"	\$265 ⁹⁹ EA
1288575	4' x 8' x 2"	\$326 ⁹⁹ EA
1288858	5' x 10' x 2"	\$479 ⁹⁹ EA
1289138	6' x 12' x 2"	\$656 ⁹⁹ EA

2 1/2" THICK EXTRA FIRM/SOFT COMBO

Fasteners On All 4 Sides

1285857	4' x 6' x 2 1/2"	\$344 ⁹⁹ EA
1286137	4' x 8' x 2 1/2"	\$411 ⁹⁹ EA
1286410	5' x 10' x 2 1/2"	\$581 ⁹⁹ EA
1286694	6' x 12' x 2 1/2"	\$739 ⁹⁹ EA

COLOR CHOICES: Choose from 14 school colors, in solids or alternating panel colors.

Due to dye lots and natural variations, vinyl colors may vary slightly if ordered at separate times.

NJ State Approved Co-op #65 MCE SCOPs Metuchen/Garden State Apparel Bid Term: 5/9/18 - 5/8/20: Extended to 5/8/21

Black Columbia Dark Green Grey Kelly Maroon Navy Orange Purple Red Royal Tan White Yellow





EZ-FLEX CARPET ROLL

- Made from soft but durable 26 oz. needle punch carpet and lightweight crossed-link polyethylene sports foam
- Each roll includes the flexible rolling system for fast, easy set up and storage
- Indestructible flame-laminated bond between the carpet and the foam
- Includes one 4" roll of hook fastener per seam (orders of 2 or more rolls)
- A full floor consists of 7 rolls 6' x 42' which combine to create a 42' square surface

3 Year Limited Warranty

Color Options: **Black, Blue, Charcoal Grey, Grey, Purple, Red, Teal.**

1450124	6' x 42' x 1 3/8" Roll (Specify Color)	\$999 ⁹⁹ EA
1450132	6' x 42' x 2" Roll (Specify Color)	\$1,199 ⁹⁹ EA



COLOR OPTIONS

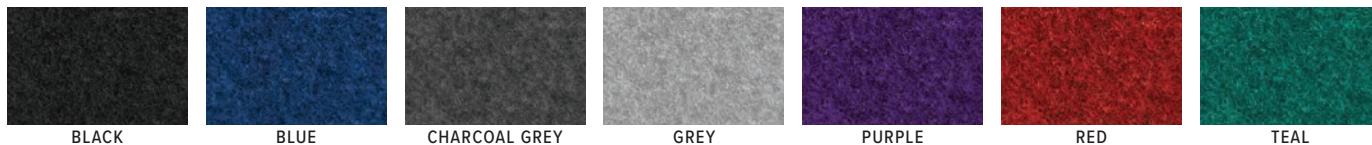

GSC TRAINING PITS

- Designed to absorb a great deal of impact and force
- Provide additional cushion to build confidence
- Covered in 18 oz. coated vinyl, topped with nylon mesh breather fabric and filled with soft polyfoam
- Nylon handles make these mats easy to move and store
- Available colors: **Black, Dark Green, Dark Purple, Grey, Kelly Green, Light Blue, Navy Blue, Orange, Red, Royal Blue, Tan, White and Yellow**
- Please allow 6 weeks for delivery

6795YXXX	5' x 10' x 16" Folding	\$1,718 ⁹⁹ EA ★	
6796YXXX	6' x 12' x 16" Folding	\$2,280 ⁹⁹ EA ★	
6798YXXX	8' x 12' x 16" Folding	\$2,916 ⁹⁹ EA ★	
6816PXXX	5' x 10' x 16" Non-Folding	\$1,812 ⁹⁹ EA ★	
6824PXXX	5' x 10' x 24" Non-Folding	\$2,394 ⁹⁹ EA ★	
1149036	6' x 12' x 16" Non-Folding	\$2,874 ⁹⁹ EA ★	
1044171	6' x 12' x 24" Non-Folding	\$3,259 ⁹⁹ EA ★	



GSC SOFLAN LANDING MATS

- Provide additional cushion to build confidence
- Covered in 18 oz. coated vinyl, topped with nylon mesh breather fabric and filled with semi-firm polyfoam
- Strategically placed nylon web handles are securely attached
- Available colors: **Black, Dark Green, Dark Purple, Grey, Kelly Green, Light Blue, Navy Blue, Orange, Red, Royal Blue, Tan, White and Yellow**
- Please allow 6 weeks for delivery

8" Thick Landing Mats

6785YXXX	5' x 10' Folding	\$999 ⁹⁹ EA ★	
6786YXXX	6' x 12' Folding	\$1,520 ⁹⁹ EA ★	
6788YXXX	8' x 12' Folding	\$1,874 ⁹⁹ EA ★	
6904YXXX	4' x 8' Non-Folding	\$583 ⁹⁹ EA ★	
6905YXXX	5' x 10' Non-Folding	\$864 ⁹⁹ EA ★	
6906YXXX	6' x 12' Non-Folding	\$1,406 ⁹⁹ EA ★	

12" Thick Landing Mats

6936YXXX	6' x 12' Folding	\$1,936 ⁹⁹ EA ★	
----------	------------------	----------------------------	--



Compare to vaulting boxes with only three sections! Great for developing motor skills!



TRAPEZOID FOAM VAULTING BOX

- Hook and loop fasteners securely hold the 4 sections together
- Use as a vaulting horse or spotting platform
- Provides the firm footing and stability required for developing jumping, motor skills and beginning gymnastic routines

1041637

48"H x 48"W x 36"L

\$1,326⁹⁹ EA ★



STRATUM VAULTING BOARD

- Adjustable 8 coil premium board
- FIG Approved
- Meets USAG, NCAA, NFHS and AAU competition specifications
- Front of the board is held at the desired tension and shape with nylon webbing strap, which prevents shifting
- Number of springs can be adjusted to meet the needs of the gymnast's weight and ability
- Constructed of gray carpet with 1/2" padding
- Black oxide springs provide desired rebound

1052138

85/8"H x 23 5/8"W x 47 1/4"L (22 x 60 x 120cm)

\$1,153⁹⁹ EA



VAULT SAFETY ZONE

- The contoured shape hugs the Stratum Vault Board to help keep gymnasts safe during round-off entries
- Meets USAG, NCAA, NFHS and AAU competition specifications
- Constructed of three internal layers of foam and reinforcement materials which adds strength and durability while covered with an anti-bacterial and anti-fungal vinyl
- Front portion of the zone slopes downward at a height of 8 1/4" (210mm) to 3-9/16" (91mm) along the 40" length of the cut-out
- Shorter sides allow air to escape and the rear edges of the zone are contoured to fit within the legs of the vault base
- 4' x 4'8" - Cut out 1/2" x 1/2" x 1/2"

1332087

Non-Folding

\$769⁹⁹ EA



DOWNHILL MATS

- Multi-use mats are ideal for teaching beginning gymnasts basic rolls and walkovers
- Polyurethane foam covered with 18 oz. reinforced, coated vinyl
- Multi-colors only

1041712

Folding 16"H x 48"W x 72"L

\$408⁹⁹ EA ★

1041705

Folding 22"H x 60"W x 120"L

\$1,020⁹⁹ EA ★

1041743

Non-Folding 15"H x 24"W x 33"L

\$183⁹⁹ EA ★

1041651

Non-Folding 16"H x 36"W x 72"L

\$357⁹⁹ EA ★

1041668

Non-Folding 16"H x 48"W x 72"L

\$377⁹⁹ EA ★

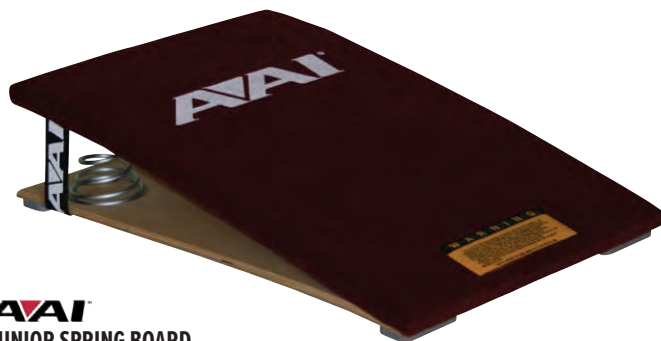

JUNIOR SPRING BOARD

- Constructed of 1/2" 8-ply cross-grain maple and poplar plywood and padded with 1/4" polyethylene foam with a carpeted surface
- Three zinc-plated wire springs are placed across the front of the bottom board
- AAI logo is placed to assist user in focusing on the board
- For children under 85 lbs.

1306293

8"H x 21"W x 33"L

\$459⁹⁹ EA



GYM CHALK

- For weight-lifting or gymnastics
- Conveniently wrapped in 2 oz. blocks
- Eight blocks per 1 lb.

PGE4360X

\$16⁹⁹ LB ★

EVERLAST®

YOUR TRANSFORMATION STARTS TODAY

BOXING



PRO STYLE GLOVES

- Constructed from durable and long-lasting synthetic leather
- Curved anatomical grip and fit
- Hook-and-loop strap for ease of use

1281828	Black-14 oz	\$39⁹⁹ PR
1281835	Black-16 oz	\$39⁹⁹ PR



NEOPRENE BAG GLOVES

- Made of comfortable and tough neoprene material
- Weighs less than 4oz
- Elastic wrist cover
- Allows both speed and power when working out.
- One Size Fits All

1310214	\$23⁹⁹ PR
----------------	-----------------------------



EVERGEL HAND WRAPS

- Evergel handwraps that provide 3 layers of gel over the knuckles to absorb the impact.
- Hook and loop wrist wrap support strap
- Color: Black
- Size: **MED, LRG, XLG.**

1263275	\$25⁹⁹ PR
----------------	-----------------------------



MANTIS MITTS

- Constructed of 100% vinyl and three layers of foam
- Curved design for ability to absorb punches
- Smaller surface helps develop speed and timing

1051216	\$49⁹⁹ PR
----------------	-----------------------------



DURAHIDE™ HEADGEAR

- Made of synthetic leather
- Offers excellent visibility
- Velcro™ closures for top and back of head
- Adjustable chin strap

1051209	\$39⁹⁹ EA
----------------	-----------------------------

DOUBLE END STRIKING BAG

- Made of high quality synthetic leather
- Double ended ball design for focused strikes
- Includes floor and ceiling fixture, shock cord and nylon rope

1281897	\$33⁹⁹ EA
----------------	-----------------------------



CARDIO FITNESS TRAINING BAG

- Easy assembly with new and improved durable foam construction for strikes
- Heavy duty spring neck for quick and responsive rebound
- Base approx. 32 lbs when filled with water
- Bag height: 5' 4"

1387105	\$99⁹⁹ EA
----------------	-----------------------------

INSIDER TIP

Using play sand instead of water to fill bases, prevents mold & creates an unyielding stance!



SPEED BAG SWIVEL

- New cotter pin makes changing bags easy
- Triple chrome plated heavy duty steel for extra long durability
- Lightning fast for pro use
- Sealed inner ball-bearing make for super quiet and efficient action

1281910 \$26⁹⁹ EA

POWER CORE BAG

- PowerCore steel plate technology improve overall strength
- PTR(Power Transfer Ring) collar offers superior impact absorption and recoil
- Compact base allows for increased accessibility
- Open base design allows for easy addition of sand or water

1281996 \$184⁹⁹ EA



EVERLAST THE NEED FOR SPEED

EVERHIDE SPEED BAG

- Everhide leather design
- Reinforced seaming for long-lasting durability
- Quick, light-weight rubber bladder insert
- Balanced for accurate rebounds

1281873 Size: 9" x 6" \$31⁹⁹ EA



EVERLAST® LEATHER SPEED BAG

- Top Grade Leather
- Reinforced seaming for long lasting durability
- Balanced for accurate rebounds

1281880 Size: 10" x 7" \$38⁹⁹ EA



6-PIECE SPEED BAG SET

- 24" smooth finished adjustable wooden drum
- Powder coated enamel brackets
- Comes with hand wraps, bag gloves, vinyl speed bag with swivel and jump rope.

1051223 \$99⁹⁹ SET



SPEED BAG PLATFORM

- Full 15-inch thick strike board with 24-inch diameter that handles all speed bag sizes
- Easily adjust platform to ideal height for any athlete using convenient spring pin lock
- Complete with swivel, two brace boards, assembly hardware and full end padding for safety
- Bag and wall mounting hardware not included

1282016 \$139⁹⁹ EA



EVERLAST IT'S IN THE BAG...

BOXING



POLY CANVAS BAG

- Specially blended filler mix of sanitized synthetic and natural fibers provides resilient shock absorbency
- Premium polycanvas with reinforced webbing along with excellent construction provides durability and functionality
- Heavy duty straps provide security and safety

NEVATEAR TRAINING BAG

- Made of durable long lasting synthetic leather
- Specially blended filler provides resilient shock absorption
- Complete with heavy-duty chain and swivel

C3 FOAM HEAVY BAG

- Contoured Closed-Cell(C3) Foam Technology provides increased cushioning and force dispersion
- Polycanvas sleeve increases durability
- Ultra durable Nevatear shell, filling stuffed with natural and synthetic fibers blended with sifted sand

1387103 70 lb \$89⁹⁹ EA
 NJ State Approved Co-op #65MCECCPS

1281965 80 lb \$89⁹⁹ EA
 1281972 100 lb \$124⁹⁹ EA

1281934 70 lbs. \$159⁹⁹ EA

Bid Term: 5/9/18 - 5/8/20! Extended to 5/8/21



CLASSIC

- Revolutionary design allows for 3 aerodynamic wind chambers to deliver a sharp, clear tone with less effort
- No cork ball to stick or deteriorate
- Unaffected by moisture
- Extremely loud, recommended for official use only

MSWHIFOX	Fox 40 Classic	\$6 ⁹⁹ EA
1240368	With Mouth Grip	\$7 ⁹⁹ EA



ECLIPSE

- The Fox 40™ Classic™ Eclipse™ has the authentic Classic sound in a sleek design and integrated co-molded Cushioned Mouth Grip (CMG™)
- No moving parts to freeze, jam or deteriorate
- Chambers are designed to self-clear when submerged in water
- Assortment includes: 2 black, 2 red, 2 orange, 2 yellow, 1 pink, 1 blue, 1 green, and 1 white

1364614	Assorted Colors with Lanyard	\$69 ⁹⁹ DZN
1296815	Black Whistle Only	\$6 ⁹⁹ EA



BREAKAWAY LANYARD

- Fox 40 Lanyards are 3/16" rope-style woven with the Fox 40 logo
- Includes J-hook and button style spring loaded adjustable cord lock
- 36" in length
- Color Options: **Black.**

1383898	Black only	\$13 ⁹⁹ DZN
----------------	------------	------------------------



ACME TORNADO 2000

- Unique design specially developed to be heard over intense crowd noise and greater distances
- Black

1376525		\$49 ⁹⁹ DZN
----------------	--	------------------------



ACME THUNDERER 60 1/2

- Famous English whistle
- Nickel-plated, tapered mouthpiece, natural cork ball

1376531		\$79 ⁹⁹ DZN
----------------	--	------------------------



ACME THUNDERER 660

- Fitted with natural cork ball, split ring

1376526		\$29 ⁹⁹ DZN
----------------	--	------------------------



MacGregor

HEAVY-DUTY NICKEL PLATED WHISTLE

1376527		\$39 ⁹⁹ DZN ★
----------------	--	--------------------------

BRASS WHISTLE

1376528		\$19 ⁹⁹ DZN ★
----------------	--	--------------------------



MacGregor

RUBBER WHISTLE COVER

- Protects lips, teeth and whistle
- Whistle not included

1376529		\$7 ⁹⁹ DZN ★
----------------	--	-------------------------



MacGregor

ECONOMY BLACK PLASTIC

- Natural cork ball and split ring

1376530		\$9 ⁹⁹ DZN ★
----------------	--	-------------------------

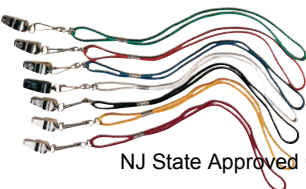

LANYARDS

- 100% nylon lanyard with clamp and swivel
- Must order 12 per color
- Whistles not included
- Color Options: **Gold, Kelly, Royal, Scarlet, White, Black, Maroon.**



WINDSOR ELECTRONIC WHISTLE

- Loud consistent sound every time
- Easier to give verbal commands without a whistle in the user's mouth
- Each set of AAA batteries produce more than 1000 blasts
- Loud 105db whistle sound can be aimed in the exact direction intended
- Improve hygiene - hand operated instead of mouth blown is sanitary for multiple users
- Comes in single tone or 3 selectable tones (pealless whistle, buzzer or alarm tone)

1. 1309980	3-Tone	\$19 ⁹⁹ EA
2. 1306989	Single Tone	\$19 ⁹⁹ EA



LAUNDRY BAGS

- White nylon mesh bag with drawstring

MSLB1824	18" x 24"	\$7 ⁹⁹ EA ★
MSLB2436	24" x 36"	\$9 ⁹⁹ EA ★



DELUXE LAUNDRY BAG

- Heavy duty 100% polyester mesh
- Cotton ID flag for player name or number marking
- Rubber closure attached
- Color Options: **Black, Gold, Royal, Scarlet, White.**

1197327	Laundry Bag -18" x 24"	\$9 ⁹⁹ EA ★
1240214	Red Rubber Closure	\$2 ⁹⁹ EA ★



SINGLE LATCH LAUNDRY BELTS

- Washes cleaner and dries more completely than bag method
- Eliminates danger of burning hands when using pin method
- Reduces noise during washing and drying
- White tag to write players # on belt
- Sold in case of 25

Color Options: **Black, Cardinal, Columbia Blue, Dark Green, Grey, Kelly, Maroon, Orange, Purple,**



1383899

Specify Color

\$66⁹⁹ CASE



K-350 STOPWATCH

- 100 Lap and split memory with 1/100 second precision
- Individual lap time, total time, fastest lap, average lap time calculation
- Two individual daily alarm
- Two row time, date, and day display
- 5 Year Limited Warranty**

1376386 \$26.99 EA ★



K-250 STOPWATCH

- 30 laps and split memory with 1/100 second precision
- 2 line display
- Fastest lap and slowest lap calculation
- Countdown timer
- 5 Year Limited Warranty**

1376385 \$19.99 EA ★



K-150 STOPWATCH

- 1/100 second precision with lap counter (for the first 30 minutes)
- Calendar and Time display(12/24 hr format)
- Daily alarm
- Hourly chime
- 5 Year Limited Warranty**

1376384 \$17.99 EA ★



TABLE TOP INFLATOR

- Lever action pump
- Heavy-duty steel cylinder, handle and clamp

MSSTPBSNY \$29.99 EA ★



STEEL HAND INFLATOR

- Compact, lightweight and portable
- Made of heavy duty steel to last through the years
- Needle included

MSHNINFSY \$6.99 EA ★



HEAVY DUTY UPRIGHT PUMP

- 21" reinforced hose
- In-line gauge provides correct pressure for all types of balls
- Needles sold separately

1069273 \$19.99 EA ★

HD INFLATOR

- 1/6 horsepower AC motor
- 80psi with pressure gauge
- Includes needle and tire valve
- Weight: 8 lbs.

1240672 \$189.99 EA ★



ECONOMY ELECTRIC INFLATOR

- High impact plastic desktop inflator
- 120v and .9 amps
- 100 psi gauge
- Coiled inflation tube that will stretch to 30"
- Comes with needle and other inflation valves

MSECOLEY \$99.99 EA ★



MINI ELECTRIC INFLATOR

- Lightweight and super quiet electric inflator
- 120v and 2.5 amps
- 150 psi gauge
- Inflation tube is 48" long
- Comes with inflation needle and other valves

1187793 \$137.99 EA ★



ACCESSORIES

- MSNEDPAC6 Needle Pack \$2.99 PACK OF 6 ★
- MSNED100 Pack of 100 Needles \$27.99 PACK OF 100 ★
- 1369558 Digital Pressure Gauge \$29.99 EA ★



DOUBLE ACTION HAND PUMP

- Compact, lightweight and portable
- Pump twice the volume of air with dual action
- Needle included

1369557 \$9.99 EA ★



AIRMAN® CORDLESS

- Simple one handed, push button operation
- Will inflate anything from balls to bicycle tires
- 9.6v rechargeable nicad battery
- 120 psi gauge
- Includes AC power cord and charger and 12v DC cord

22006XXX \$77.99 EA



Bid #ESCNJ 17/18-31

Educational Services Commission of New Jersey

Athletic Equipment & Supplies



MV-10S MEGAPHONE

- 600 yard range - 16 watts of power
- Used by U.S. Army, Navy, Air Force and Marines
- For indoor/outdoor use
- Variable volume control
- Solid-state, built-in microphone
- Foghorn signal
- Operates on (6) C batteries (not included)

MV10S \$179⁹⁹ EA



MV-20S MEGAPHONE

- 1000 yard range - 25 watts of power
- Microphone hooks to end or detached with shoulder strap
- Solid state amplifier has signal alarm for warning alert
- Dynamic microphone with coiled cord and talk switch
- Pistol-trigger switch
- Operates on (8) C batteries (not included)

1271331 \$234⁹⁹ EA



MV-16S MEGAPHONE

- 800 yard range - 20 watts of power
- Signal alarm switch
- Pistol-trigger talk switch
- Dynamic microphone
- Carrying strap
- Weatherproof construction
- Operates on (8) C batteries (not included)

1271324 \$198⁹⁹ EA



LONG RANGE MEGAPHONES

- 1000 yard range - 25 watts of power
- Adjustable volume control
- Siren button
- High impact PVC construction
- Operates on (8) C batteries (not included)
- Weight: 7 lbs.

MSMEG61W Hand Held Mic \$126⁹⁹ EA ★
MSMEG51W Built-in Trigger Mic \$86⁹⁹ EA ★



MINI MEGAPHONE

- 300 yard range - 8 watts of power
- Trigger controlled; adjustable volume control; siren button
- High impact plastic with carrying strap
- Built-in microphone
- Operates on (6) AA batteries (not included)

MSMEG22W \$57⁹⁹ EA ★



VOICE RECORDING MEGAPHONE

- 800 yard range - 20 watts of power
- Features the ability to use as a portable message center
- Record up to a 60 second message and it will repeat hands free
- Siren switch
- Operates on (8) C batteries (not included)

1248531 \$159⁹⁹ EA ★



PORTABLE SIGNAL HORN

- Offers a loud sound with a long lasting 8 oz. canister
- Push-button style, high-impact construction
- CANNOT BE SHIPPED BY AIR

MSAIR82H \$29⁹⁹ EA
MSAIR82R 8 oz. Refill \$19⁹⁹ EA



NEW!

MIPRO MA303

- Portable Wireless Single-Receiver 60-Watt PA w/ Bluetooth
- AC & Battery powered
- 16 channel wireless receiver built-in
- INCLUDES either a Handheld or Body Pack Mic system
- Built-in Bluetooth music player for wireless audio streaming
- 3.5 mm line-in accepts external MP3, iPod or CD player
- USB Player / Recorder
- 10 hour standby time; 4 hour battery charge time
- 6 lbs - 8.3" W x 11" H x 6.5" D

1398828 With Headworn Mic \$699⁹⁹ EA
1398829 With Handheld Mic \$699⁹⁹ EA



VOICE BLASTER

- 100 yard range - 5 watts of power
- Features a 2 1/2" speaker on an adjustable belt that fits up to a 50" waist
- Includes a re-chargeable battery adapter
- Constructed of heavy duty plastic and weighs less than 2 lbs.

1162769 \$69⁹⁹ EA ★



MEGAPHONE STORAGE BAG

- Foam padded, nylon bag
- Features a heavy-duty zipper top and carrying handle
- 14"H x 9"Dia. - for all sizes of megaphones

1271489

NJ State Approved Co-op #65MCE SCCPS Metuchen/Garden State Appar. Bid Term: 5/9/18 to 5/8/20. Extended to 5/8/21

PORTA PHONE GS-2

- Coaches can talk simultaneously
- Entire staff is completely mobile, even in the pressbox
- Radio installed inside the earcup
- Lightweight headset
- Range over 1/4 mile

1399576	2 Coaches	\$1,449 ⁹⁹ SET
1399577	3 Coaches	\$1,994 ⁹⁹ SET
1399578	4 Coaches	\$2,499 ⁹⁹ SET
1399579	5 Coaches	\$2,994 ⁹⁹ SET

PORTA PHONE GHC-5

1399580	5 Coaches	\$3,249 ⁹⁹ SET
1399581	6 Coaches	\$3,799 ⁹⁹ SET
1399582	7 Coaches	\$4,299 ⁹⁹ SET
1399583	8 Coaches	\$4,799 ⁹⁹ SET
1399584	9 Coaches	\$5,299 ⁹⁹ SET



FRONTROW TO GO PA SYSTEM

- A simple all-in-one system - just charge it and go
- Features DuO™ technology - multiple speakers in a single cabinet
- Capable of covering an entire gym, classroom, playground or field
- Weighs only 13 lbs. and features a dual FM receiver (allows 2 transmitters to be used at once), and a rechargeable battery (with 6 1/2 hours operating time)
- Includes auxiliary to connect to TV/VCR/DVD, computer, CD player and iPod
- Includes speaker system, head worn microphone with transmitter, charging stand, auxiliary and power cords

5 Year Limited Warranty

1274585

\$1,679⁹⁹ EA



COACHES RADIO PACKAGE

- 2 Motorola® RMU2040 4-watt radios
- 2 each Eartec Ultra, heavy-duty, single earmuff headsets with built-in microphone
- Rechargeable batteries
- Belt clips and chargers
- For immediate communication between field and press box

682128

\$1,199⁹⁹ EA ★



SINGLE MUFF HEADSET

- Headset to use in noisy areas without needing to remove radio from belt
- Hear audio in quiet environment without disturbing others
- Noise cancelling boom microphone
- Covers right ear
- Works on VOX equipped radios
- For use with CLS, XTN and RDX series radios

1202038

\$244⁹⁹ EA



BEHIND-THE-NECK MIC

- Additional head-worn microphone for FrontRow To Go PA System (Item 1274585)

1274592

Requires body transmitter (1274608)

\$164⁹⁹ EA



BODY-WORN TRANSMITTER

- Required to operate head-worn mic (Item 1274592)

1274608

\$324⁹⁹ EA



CLS SERIES RADIOS

- UHF business 2-way radio
- 1 watt UHF transmit power
- 56 selectable UHF frequencies (12.5KHz channel spacing)
- Interference eliminator with 121 codes (83 digital / 38 analog)
- LCD display with battery signal strength indicator
- "Call Alert" button with 3 tones
- Vibrate mode (Model 682131 only)
- Range / coverage up to 200,000 sq feet or 15 floors
- Includes battery, charger and belt clip holster

682131

1 Watt, 4 Channels

\$299⁹⁹ EA

1239553

1 Watt, 1 Channel

\$259⁹⁹ EA

6 UNIT CHARGER

- Charge up to 6 radios or batteries in 3-10 hours
- Copies or clones programming from one radio to another
- Desk or wall mountable
- Radios not included

1245691

For CLS Series

\$289⁹⁹ EA



WIRELESS HAND-HELD MIC

- Hand-held microphone for FrontRow To Go PA system (Item 1274585)

1274615

\$319⁹⁹ EA



CARRY BAG

- Stores and transports the FrontRow To Go PA system (Item 1274585)

1274622

\$109⁹⁹ EA

EARBUD WITH PTT MIC

- For use with CLS, XTN and RDX radios

1239577

\$84⁹⁹ EA

EARPIECE W/ CLIP-ON MIC

- For use with CLS, XTN and RDX radios



'STEAMIN' DEMON' HOT DOG STEAMER

- Contains stainless steel cabinet and lid (no painted parts)
- Hot dog juice tray
- Holds 80-90 hot dogs, 30-40 buns, and six quarts of water
- 1000 watts, 8.3 amps, 120 volt
- Weight: 32 lbs.

5GM8007 Size - 19"W x 16"H x 15.5"D **\$894⁹⁹** EA



'DOGEROO' HOT DOG COOKER

- Holds 56 hot dogs and 40 buns
- Bun warmer sits over a water pan providing moist heat to keep hot dogs in a bun and foil bag warm
- Easy to clean
- 1680 watts, 120 volts
- Weight: 60 lbs.

5GM8102 Size - 21"W x 28"H x 15"D **\$1,449⁹⁹** EA



'MINI DOGEROO' HOT DOG COOKER

- Small footprint is ideal for concession areas with limited space
- Holds 18 dogs
- 750 watts, 120 volts
- Weight: 47 lbs.

5GM8108 Size - 13"W x 26.5"H x 15"D **\$1,229⁹⁹** EA

ECONO FLOSS COTTON CANDY MACHINE

- Stainless steel cabinet
- Spun aluminum bowl
- "Whirl Grip" floss stabilizer
- Single 5-1/2" ribbon machine produces over 200 oz. per hour
- 1320 watts, 11 amps, 120 volts
- Size - 26-1/2"W x 26-1/2"D x 20"H.
- Weight: 37 lbs
- Optional dome not included.

5GM3017SS Cotton Candy Machine **\$1,489⁹⁹** EA
5GM320 Flossugar - 19.5 lbs (Pink or Raspberry) **\$48⁹⁹** CASE
5GM3065 Cotton Candy Bags **\$99⁹⁹** CASE OF 1000
5GM3021 Cotton Candy Cones **\$139⁹⁹** CASE OF 4000
1033632 Optional Plastic Dome **\$384⁹⁹** EA



STAINLESS STEEL MICROWAVE

- 1000 watts and 1.1 cubic feet of cooking space
- Black finish front with chrome handles and stainless cabinet
- 10 power levels and 8 one touch settings with speed and weight defrost
- LED display, digital clock, kitchen timer and child-safe lock
- Weight: 33 lbs.

1052466 Size - 20.5"W x 13.2"H x 17.5"D **\$269⁹⁹** EA

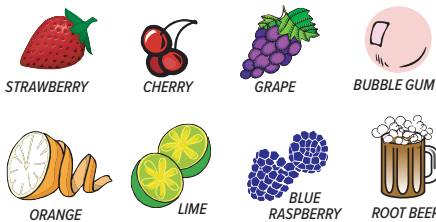

SNO-KONETTE

- Easy to operate: lift the pusher handle, fill with chunks of ice, turn on the motor and pull the handle
- 1/3 HP, 1725 RPM high-speed shaver mounted on aluminum cabinet with tempered glass windows
- Shaves up to 500 lbs. of ice per hour
- Includes: cup dispenser, sno-cone dipper, ice scoop and drain pan
- Measures 22"W x 16"D x 19"H. 816 watts 6.8 amps on 120 volts
- Weight: 67 lbs. (Will not ship UPS)

MSSK1003 Sno-Konette - Size - 22"W x 16"D x 19"H **\$1,379⁹⁹** EA
5GM5122 Sno-Kone Syrup - 4 Gallons **\$48⁹⁹** CASE OF 4
5GM1060



HAWAII'S FINEST SHAVED ICE MACHINE

- 1/3 HP motor and stainless steel components for trouble-free use

1058826 Size - 15.5"W x 20"H x 21.5"D **\$2,279⁹⁹** EA

Bid #ESCNJ 17/18-31

Educational Services Commission of New Jersey

Athletic Equipment & Supplies

CONCESSIONS



FRUSHEEZ[™] SLUSH MACHINE

- Popular self contained twin bowl design
- Serves two delicious frozen flavors simultaneously
- 3.7 gallon capacity per bowl
- Just add easy to use Frushee[™] slush mix
- 32 7/8" H x 15" W x 15" D
- Add 3-5/8" - 4-3/4" for adjustable legs

1181302 Twin Bowl - Size - 33"H x 15" W x 15"D \$3,579⁹⁹ EA

FRUSHEEZ[™] SLUSH DRINK MIX

- Mix four parts water to one part of concentrated mix
- Specify flavor
- Flavor: **Blue Raspberry, Cherry, Lemon, Grape, Fruit Punch, Orange, Straw Daiquiri.**

1181319 1/2 Gallon \$15⁹⁹ EA

FRUSHEEZ[™] PLASTIC CUPS

- Sold by the case only
- 14 oz. plastic cups

1181388 Case of 1000 \$199⁹⁹ EA



NACHO CHIP MERCHANDISER

- Stainless steel top and bottom
- Sidelight enhanced

1058857 Size - 12"W x 15.5"D x 23.5"H \$579⁹⁹ EA



DELUXE SIXTY POPPER WITH CART

- Features antique styling, etched glass, cast filigree, brass-like antique finish and 6oz. kettle popper

1058796 Size - 18"W x 16"D x 36"H \$1,989⁹⁹ EA



DELUXE 60 POPCORN POPPER

- 6 oz. spun aluminum kettle for fast warm up and consecutive 3 minute popping cycles
- Heavy-duty kettle drive motor, tempered glass, and strip heater corn freshener under the deck of the popper
- Measures 18"W x 16"D x 31"H.
- Weight: 56 lbs.

5GM2085 Popcorn Popper \$969⁹⁹ EA
 5GM2053 1 oz. Popcorn Bags - 1000 CT \$39⁹⁹ PACK OF 1000
 5GM2836 6 oz. Corn Kit - 36 CT \$59⁹⁹ KIT OF 36



EL NACHO GRANDE

- Maintains air tight control over cheese sauce
- Eliminates messes and limits cleaning maintenance
- Has space for a second bag to pre-heat inside
- Works with all brands of bagged cheese
- Weight: 18 lbs

1058833 Size - 26"W x 10"W x 16"D \$779⁹⁹ EA
 1058840 Nacho Cheese, Case of 4, 140 oz. Bags \$54⁹⁹ EA
 1058802 Chili, Case of 4, 106 oz. Bags \$99⁹⁹ EA



WHIZ BANG POPCORN POPPER

- "Top of the line" 12/14oz. kettle popper
- Uni-maxx Kettle mounted in extra strong cast aluminum hanger arms
- Produces 250, one oz. servings per hour
- Removable kettle for easy cleaning
- Weight: 105 lbs.

1277104 Size - 28"W x 20.5"L x 40"H \$1,879⁹⁹ EA

No State Approved Co-op #65MCESCCPS, Metuchen/Garden State Apparel Bid Term: 5/9/18 to 5/8/20, Extended to 5/8/21



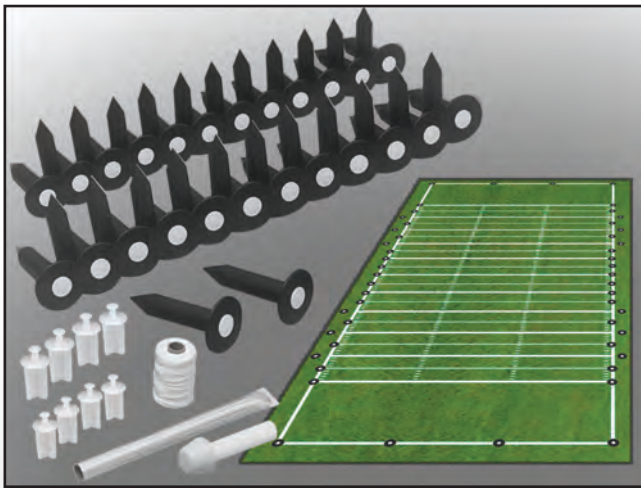

FOOTBALL FIELD LINING SET

- Set includes 50 sockets with plugs
- Installation accessory kit
- Marks complete football field - 5 yard increments, goals and hash marks

MKFLP50

\$449⁹⁹ EA

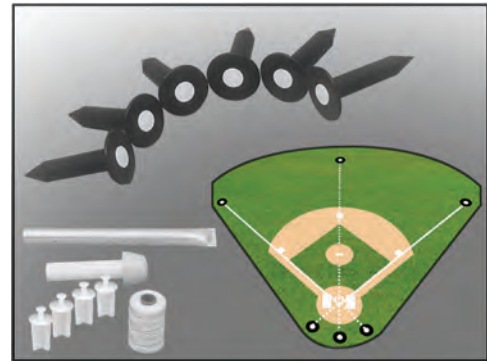

BASEBALL FIELD LINING KIT

- The essential kit to properly line all baseball or softball fields
- Provides 6 ground sockets to establish perimeter and midfield locations and hold game day markers
- Kit includes: 6 sockets with plugs, 4 lining pegs, pilot hole tube and socket setter

MKBLP6

\$99⁹⁹ EA

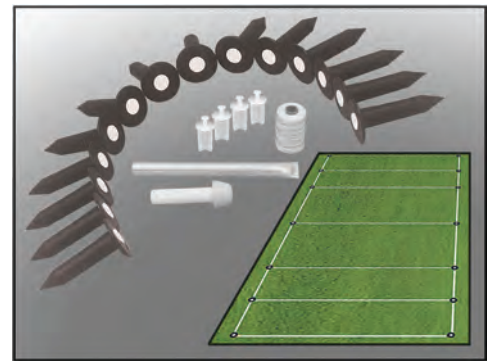

MARKSMART™ INTRAMURAL LINING PACKAGE

- Most intramural and club sports require 14 line intersection reference points of the field
- Everything you need to establish permanent reference locations for flag football, lacrosse, field hockey, rugby and others
- Set includes: 14 sockets w/plugs and installation accessory kit

MKILP14

\$164⁹⁹ EA

“ANYTIME IS THE RIGHT TIME TO PERMANENTLY MARK FIELDS... BEFORE, DURING, OR AFTER THE SEASON!”

DO IT ALL WITH ONE SET

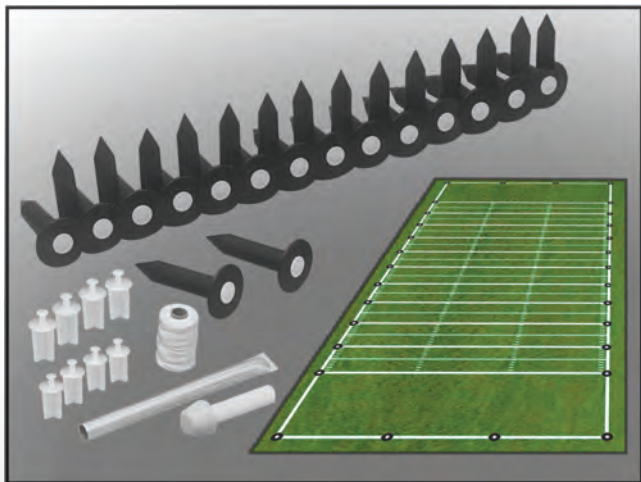

FOOTBALL PRACTICE OR BAND LINING SET

- Set boundary lines, goal lines, every ten yard lines and hash marks
- Great for band practice fields as well
- Set includes 30 sockets with plugs
- Installation accessory kit

MKPFLP30

\$199⁹⁹ EA

FM ACCESSORIES

GROUND SOCKET CAPS

- 12 pack of plugs for MarkSmart ground sockets
- Use color coded cap for multiple field configurations

Color Options: **Orange, White, Yellow.**

MKA103Y

Caps Only - Specify Color

\$14⁹⁹ DEN

GROUND SOCKET WITH CAP

- Individual 8" ground socket with plug

MKA101

Ground Socket with Plug

\$9⁹⁹ EA

HEAVY DUTY POLYESTER TWINE IN 500 FOOT ROLL

- Heavy duty twisted polyester rope.

MKA102

\$15⁹⁹ EA

GROUND SOCKET LINING PEGS - 10/SET

- 10 pack of lining pegs for MarkSmart lining system
- Insert in ground sockets to attach twine

MKA104

\$15⁹⁹ SET

GROUND SOCKET AUGER

- Use to set your ground sockets in place
- Attaches to any standard drill; size: 3/8" shaft, 1 1/4"

MKGS12

\$29⁹⁹ EA

GROUND SOCKET PUNCH-PILOT HOLE TOOL

- Easy to use pilot hole tool for ground socket installation
- Helps to remove soil/dirt and create a crevice for ground socket insertion

MKA105

\$14⁹⁹ EA

PAIR OF GROUND SOCKET SETTERS

- Designed to be placed in the ground socket so you can hit these instead of the ground socket directly

MKA106

\$4⁹⁹ PR

TWINE OR CORD REEL - NO TWINE INCLUDED

MKTCR10

\$19⁹⁹ EA

TWINE REEL WITH 500 FEET OF HEAVY DUTY POLYESTER ROPE

Includes 500 feet of heavy

MKTCR638

\$29⁹⁹ EA

COMBINATION VALUE PACKS FOR A COMPLETE SOCCER FIELD

FIELD MARKING



SPRING LOADED SOCCER CORNER FLAGS

- Spring loaded corner flags that "give" when contacted by a player and return upright automatically
- 2-Piece 1.33" O.D. PVC poles
- High visibility orange flags

- Includes: 4 flags with ground sockets with plugs, installation accessory kit and storage bag.

MK4X4S 60"H \$169.99 SET

- Includes: 6 flags with ground sockets with plugs, installation accessory kit and storage bag.

MK6X6S 60"H \$229.99 SET

- Includes: 6 flags and storage bag. Ground sockets not included.

MK6FB 60"H \$169.99 SET

MKA101 Ground Socket with Plug \$9.99 EA

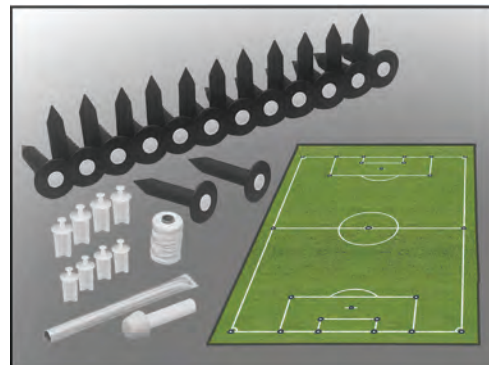

SOCCER FIELD LINING KIT

- Set includes: 25 sockets with plugs, 8 line pegs, installation accessory kit (IAK).
- All the necessary tools and products to establish permanent reference points for a regulation soccer field

MKSLP25 \$254.99 EA

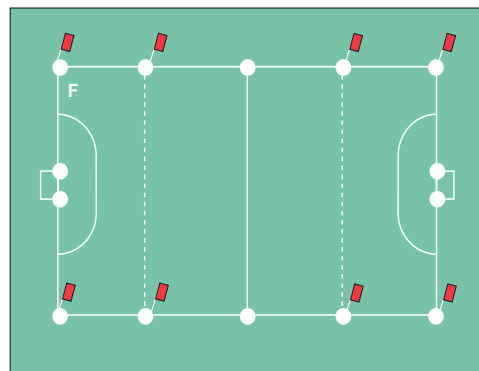

FIELD HOCKEY MARKING SET

- 14 ground sockets with plugs
- 6 Tufflag game day flags
- Installation accessory kit
- Storage bag

MKFH146 \$284.99 SET

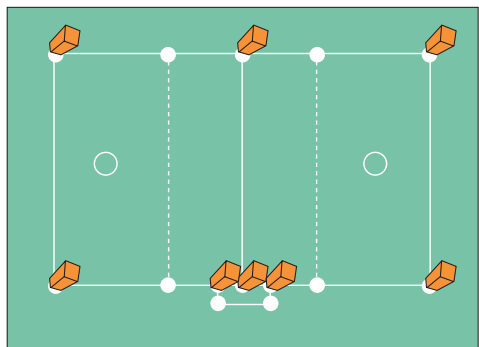

LACROSSE MARKING SET

- 14 ground sockets with plugs
- 8 pylons

1162417 \$314.99 SET



MARK YOUR SOCCER FIELD WITHOUT THE HASSLE!



REFLEX SOCCER CORNER FLAGS

- Reflex corner flag
- 1-Piece 1.33" O.D. PVC poles
- High visibility orange flags

- Includes: 4 flags with ground sockets & plugs and installation accessory kit. Storage bag not included

MK4RFGSP 66"H \$149.99 SET

- Includes: 6 flags with ground sockets & plugs and installation accessory kit. Storage bag not included.

MK6RFGSP 66"H \$194.99 SET

- Includes: 4 flags and storage bag. Ground sockets not included.

MK4FB 66"H \$134.99 SET

MKA101 Ground Socket with Plug \$9.99 EA

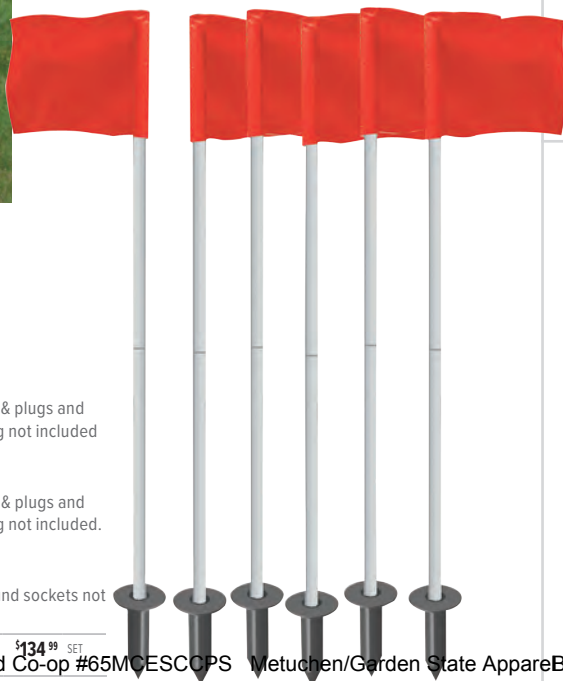

FIELDLAZER™ STRIPER

- Exclusive tall-wheel cart rolls easily over ruts and cleat marks
- Easy out filter makes tip clogs a thing of the past
- 35cc Honda 4 stroke engine
- Three semi pneumatic 14" tires
- 900 psi
- Gas tank holds .65 gallons and should be good for 45 minutes
- Adjustable spray shields make line width changes from 4"-8" fast and easy with no tools
- Siphons from the original 5 gallon paint container to eliminate tank and pot cleaning hassles
- Fold-down handle makes transportation easy; Weight: 80 lbs.



1179477 5 Gallon Capacity \$3,899⁹⁹ EA
 1236286 30" Tip Extension \$99⁹⁹ EA



AIRLESSCO FIELD STRIPE PLUS (+)

- RADIUS MEMORY delivers smooth consistent curves and circles
- 160cc Honda 5.5 hp engine
- 3000 psi
- Gas tank holds 1 gallon

1237085 5 Gallon Capacity \$4,919⁹⁹ EA

TRUeline® AIRLESS SPRAY STRIPER

- Stainless steel paint tank
- Four 10" pneumatic tires
- 120 psi
- 10 lb. CO2 cylinder holds enough pressure to stripe 20 football fields before refilling (paint not included)
- 4" spray box
- Choose between 7 or 12 gallon paint tanks



1237030 7 Gallon Capacity \$1,849⁹⁹ EA
 1237047 12 Gallon Capacity \$1,999⁹⁹ EA

FIELD MARKING PAINT

- Concentrate paint eliminates the need to measure
- 1 gal. pail of concentrate = 5 gal. of paint when combined with 4 gal of water
- 5 gal. pail is 5 pre-mixed gallons of paint.



1379971 1 Gallon Pail - White \$66⁹⁹ EA
 1379972 5 Gallon Pail-Specify Color \$179⁹⁹ EA



ECOLINER™ BATTERY POWERED FIELD STRIPING MACHINE

- Features a heavy duty, diaphragm pump powered by a 12-volt deep cycle battery, never flat tires and all steel construction
- Quickly paint professional quality lines for hours on a single battery charge
- Simply, place a 5-gallon pail of premixed paint on the machine and you are ready to mark your field
- No pressurized tanks. No need to release pressure to add paint or clean. No high-pressure pump output to prohibit operator injury
- Line width is fully adjustable from 2"-6", allowing for greater flexibility to meet your field marking needs
- Equipped with a quick charge 120V plug in battery charger to provide the fastest charging time available.



18 Month Limited Warranty No State Approved Co-op #65MCESCCPS Metuchen/Garden State Apparel Bid Term: 5/9/18 - 5/8/20; Extended to 5/8/21
 5NSECLNR 5 Gallon Capacity \$1,999⁹⁹ EA



FOOTBALL FIELD STENCIL KIT

- Kit contains 0-5, G and directional arrow
- Cut from 1/8" plastic - ultimate durability
- Keeps your field clearly and attractively marked

1385374 \$899⁹⁹ SET

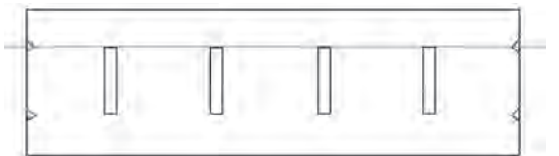

FOOTBALL HASH MARK GUIDE

- Made from tough Coroplast material
- Easy to use - will fit between yard lines
- Paint through template
- V notches for string alignment

1162653 \$289⁹⁹ EA

Bid #ESCNJ 17/18-31

Educational Services Commission of New Jersey Athletic Equipment & Supplies



FIELD MARKING



4-WHEEL LINE MARKERS W/ PNEUMATIC TIRES

- The most durable line marker on the market
- 11 gauge steel frame
- 18 gauge galvanized steel bucket
- Tires measure 3.5"W x 10"D
- Easily adjustable to either 2" or 4" lines

18 Month Limited Warranty

1. BBHDDM10	100 lb. Capacity	\$369⁹⁹ EA ★
2. BBHDDM50	50 lb. Capacity	\$339⁹⁹ EA ★

4-WHEEL DRY LINE MARKER

- All steel construction
- 4 hard rubber wheels for extra durability
- Easily adjustable to either 2" or 4" lines

3. BBDLM654	4-Wheel 65 lb. Capacity	\$259⁹⁹ EA ★
--------------------	-------------------------	--------------------------------

2-WHEEL DRY LINE MARKER

- All steel construction
- 2 hard rubber wheels for extra durability
- Easily adjustable to either 2" or 4" lines

4. BBDLM252	2-Wheel 25 lb. Capacity	\$174⁹⁹ EA ★
--------------------	-------------------------	--------------------------------

ATHLETIC FIELD STRIPPER

- For use on grass, dirt, concrete, pavement or gravel
- Sturdy steel construction with 4 large, easy rolling wheels and a collapsible handle for easy storage
- Lightweight housing includes windscreen, fingertip on/off lever, storage for 12 extra cans and simple 2" - 4" line width adjustment
- Non-toxic aerosol spray goes straight downward for complete coverage (paint sold separately)
- Maintenance free, no messy clean up



0795XXXX **\$144⁹⁹** EA



ATHLETIC FIELD MARKING DUST

- Bright premium marking dust complies with the NCAA rules
- Non-toxic, non-burning and harmless to soil and turf
- 50 lb. bags/40 bags per pallet
- **Actual freight charges apply**



DPR0MD **\$679⁹⁹** PALLET

STRIPING WAND

- Use for convenient touch-up of lines or stenciling
- Sturdy, lightweight construction
- Works with Mark1 field striping paint

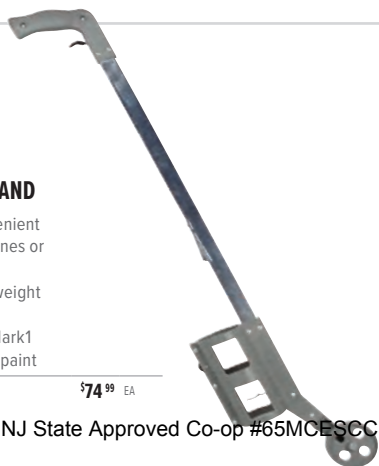

1237092 **\$74⁹⁹** EA



FIELD STRIPING PAINT

- Our 3 main colors, White, Orange and Yellow will give you up to 700 feet of spray based on a 4" line
- Compare that with others that offer only 300-400 feet based on a 4" line. That's like getting 2 cans for the price of one
- Will not flake or wash away
- Cans are 20 oz. capacity and 17 oz. by weight

Case Price (12 Cans)

0792XXXX	White	\$67⁹⁹ CASE OF 12 CANS
0792ORXX	Orange	\$67⁹⁹ CASE OF 12 CANS
0792YLXX	Yellow	\$67⁹⁹ CASE OF 12 CANS
0792CXXX	Other colors - Standard Nozzle	\$82⁹⁹ CASE OF 12 CANS

3 Case Master (36 Cans) Save!!

0792PACK	White	\$169⁹⁹ PACK OF 36 CANS
0792CPACOR	Orange	\$169⁹⁹ PACK OF 36 CANS
0792CPACYL	Yellow	\$169⁹⁹ PACK OF 36 CANS
0792CPAC	Other colors - Standard Nozzle	\$199⁹⁹ PACK OF 36 CANS



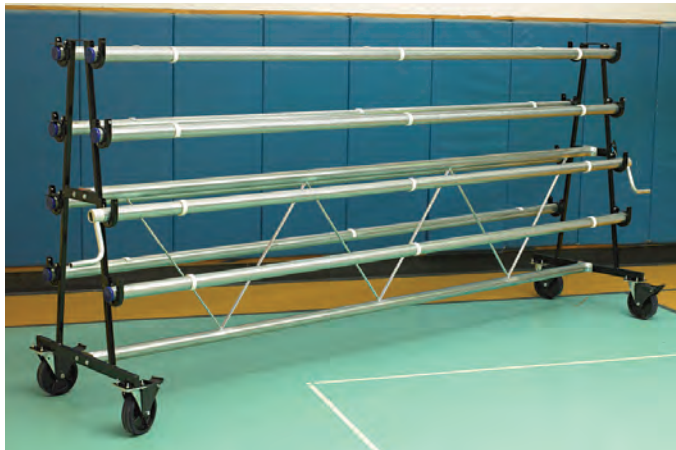

GYM FLOOR COVER MOBILE STORAGE RACKS

- Use with 10' wide sections only
- All steel rack with Delrin roller bearings
- Supports up to 2800 lbs.
- Four 8" diameter non-marring wheels for easy rolling (2 with locks)
- Includes 2 hand cranks for winding, 3 fabric clips per roller, and instructions
- 2 1/2" diam., 14 gauge steel rollers with locks to prevent accidental unwinding
- 67"H x 34"W x 12'6"L

6 Year Limited Warranty

1048407	6 Roller Model	\$3,199 ⁹⁹ EA	
1048414	8 Roller Model	\$3,729 ⁹⁹ EA	
1048421	10 Roller Model	\$3,929 ⁹⁹ EA	



GYM FLOOR COVER PREMIER STORAGE RACKS

- Same design as our standard Mobile Storage Racks with added features
- 6 casters instead of 4 to spread the floor load
- Leg extenders for increased stability
- Storage bins on the ends to store accessories
- 67"H x 34"W x 12'6"L

6 Year Limited Warranty

1279856	6 Roller Model	\$3,929 ⁹⁹ EA	
1279863	8 Roller Model	\$4,209 ⁹⁹ EA	
1279870	10 Roller Model	\$4,359 ⁹⁹ EA	



ELECTRIC POWER WINDER

- Quickly and easily winds up each gym floor cover section

1048438	\$1,279 ⁹⁹ EA	
---------	--------------------------	--



RACK BRUSH ASSEMBLY

- Bolts to the rack to remove debris from your floor cover as you roll it up

1248647	\$899 ⁹⁹ EA
---------	------------------------



STORAGE RACK COVER

- Keeps your floor cover and rack clean and hidden
- Custom lettering available - call for options and prices

3 Year Limited Warranty

1248401	\$389 ⁹⁹ EA
---------	------------------------



WALKWAY RUNNER MATS

- Heavy duty design for heavy traffic areas in hallways, foyers and in front of bleachers
- 1/8" thick durable vinyl runner with corrugated design promotes safety and protects your floor
- Runner mats are a great supplement to a gymnasium floor cover
- Available in Black 105' rolls

1237580	2'W x 105'L - 160 lbs.	\$489 ⁹⁹ EA
1237597	3'W x 105'L - 236 lbs.	\$619 ⁹⁹ EA
1237610	4'W x 105'L - 305 lbs.	\$749 ⁹⁹ EA

FLOOR COVER TAPE DISPENSERS

- For floor cover tape up to 3" wide

1. 1270419	Hand Held	\$40 ⁹⁹ EA
2. 1270426	Upright Walk Behind	\$379 ⁹⁹ EA

FLOOR COVER TAPE

- Secures overlaps and edges without leaving residue on floor or cover
- Purchase two cases of tape and receive a "FREE" walk behind tape dispenser (1 per customer)

3. 1270587	16 Rolls - 3" X 36 yds	\$182 ⁹⁹ CASE
------------	------------------------	--------------------------

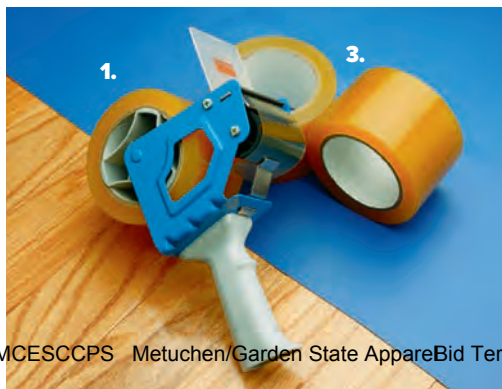

Bid #ESCNJ 17/18-31

Educational Services Commission of New Jersey Athletic Equipment & Supplies

SAVE BY PURCHASING PRE-CUT COVERS!

DELUXE GYM FLOOR COVERS

BUILT TOUGH TO PROTECT YOUR INVESTMENT!

- Ultra-durable 3-ply fabrics
- Reinforcing polyester mesh yarns coated with PVC on both sides
- Seams are engineered to be as strong as the fabric itself (Meets Military and Dept. of Defense requirements)
- Use either side up - will lay smooth and flat
- Fabric is anti-bacterial, anti-fungal and rot and mildew resistant
- Meets stringent flame retardant standards including California Fire Marshall, NFPA 701 and UL 300
- Order in 10' wide sections adding 6" - 12" for overlapping
- Example: For a 75' x 110' floor, order 8 sections 10' x 110'

1369726	18 oz., 8 Yr. Warranty	\$0.79	SQ.FT	
1048315	22oz., 10 Yr Warranty	\$0.91	SQ.FT	
1083743	27 oz., 15 Yr Warranty	\$1.08	SQ.FT	
1270433	32 oz., 17 Yr Warranty	\$1.16	SQ.FT	

18 OZ. COLOR OPTIONS:

Black, Burgundy, Green, Kelly Green, Light Gray, Navy Blue, Orange, Red, Royal Blue, Tan, Yellow

22 OZ. COLOR OPTIONS:

Black, Brown/Tan, Burgundy, Green, Light Gray, Navy Blue, Red, Royal Blue, Tan, Tan/Royal Blue, Yellow



*ADA COMPLIANT. COLORS MAY VARY.

27 & 32 OZ. COLOR OPTIONS:

Black, Brown/Tan, Burgundy, Dark Gray, Green, Navy Blue, Red, Royal Blue, Tan, Tan/Burgundy, Tan/Royal Blue



PRE-CUT GYM FLOOR COVERS

- Durable, vinyl cover protects your gym floor during non-athletic events
- Covers are already cut to 10'W x 100'L sections
- Color Options: **Royal Blue, Tan.**

1369718	18 oz., 8 Yr. Warranty	\$779.99	EA	
1162677	22 oz., 10 Yr. Warranty	\$919.99	EA	
1375308	27 oz., 15 Yr Warranty	\$1,099.99	EA	
1375310	32 oz., 17 Yr Warranty	\$1,179.99	EA	



PRO SHIELD GYM FLOOR COVER TILE

- Beautiful acoustic carpet tiles for all kinds of events
- No need for tape, tiles will lie flat and won't slide
- 100% solution-dyed polypropylene top surface and a non-staining polyolefin backing
- Lightweight for quick set up and breakdown
- Approximately 39 3/8" x 78 3/4" (22 lbs. per tile)

3 Year Limited Warranty

Color Options: **Blue, Grey.**

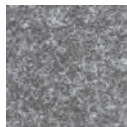

GREY

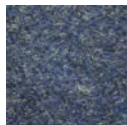

BLUE

PRO SHIELD GYM FLOOR TILE CART

- Stores and transports your gym floor cover tiles
- Steel frame with a carpeted plywood platform
- Features 5" casters and removable 29" handle
- 950 lb. capacity (70-80 tiles)

3 Year Limited Warranty

1384780 NJ State Approved Co-op #65 MCESCCPS



NEW!

DESIGN PRINT™ LOGO MAT

- Our Design Print™ Logo Mat features Jet Print Technology injecting dyes deeply and permanently into the 3/8" thick pile to produce colorful logos
- 100% heat set nylon with jet print dye and durable vinyl backing
- Used in high traffic entrances, lobbies, court sidelines, schools, recreation centers, churches and more
- Custom sizes up to 60' long
- Requirements: size, color, logo in PDF/logo direction
- Additional color options available

Color Options: **Apricot, Bark, Black, Forest, Graphite, Lemon, Navy, Orange, Sky, Strawberry, Ultraviolet.**

1450140	3' x 5' (Specify Color)	\$279.99	EA	
1450152	3' x 20' (Specify Color)	\$929.99	EA	
1450164	3' x 30' (Specify Color)	\$1,389.99	EA	
1450176	4' x 6' (Specify Color)	\$369.99	EA	
1450188	4' x 20' (Specify Color)	\$1,139.99	EA	
1450200	4' x 30' (Specify Color)	\$1,699.99	EA	
1450212	Custom (Specify Size & Color)	\$15.99	SQ.FT	



Bid #ESCNJ 17/18-31

Educational Services Commission of New Jersey

Athletic Equipment & Supplies



STIGA
STS520 TABLE

- 1" tournament blue top with silk screen lines
- 2 1/2" self opening, heavy duty steel legs with leg levelers and welded cross brace
- 2 1/2" powder coated, steel apron with full length ball storage and corner protectors
- 5" mag wheels with sports tread tires, single sided swing arms and 2 locking wheels
- 72" premium net and post system with tension adjustment and spring clip mounting
- Features an extra heavy-duty Euro design chassis for unmatched support
- Folds for playback and storage

1375131

\$999⁹⁹ EA 

STIGA
STS420 TABLE

- 1" tournament blue top with silk screen lines
- 2 1/2" self opening, sturdy steel legs with leg levelers and welded cross brace
- 2 1/2" powder coated, steel apron with full ball storage and corner protectors
- 5" mag wheels with tread tires, single sided swing arms and 2 locking wheels
- 72" premium net and post system with tension adjustment and spring clip mounting
- Patented quickplay chassis for quick and easy assembly
- Folds for playback and storage

1375130

\$919⁹⁹ EA 

STIGA
STS385 TABLE

- 3/4" tournament blue top with silk screen lines
- 2" self opening, heavy duty steel legs with leg levelers
- 2" powder coated, steel apron with ball storage and corner protectors
- 5" mag wheels with sports tread tires, single sided swing arms and 2 locking wheels
- 72" premium net and post system with tension adjustment and spring clip mounting
- Folds for playback and storage

1375129

\$799⁹⁹ EA 

STIGA
STS285 TABLE

- 3/4" tournament blue top with silk screen lines
- 2" self opening steel legs
- 2" powder coated, steel apron with ball storage and corner protectors
- 3" mag wheels with sports tread tires, single sided swing arms and 4 locking wheels
- 72" pivoting net and post system with tension adjustments is integrated into the table to allow opening and closing without removing net
- Ready to play right out of the box - no assembly required
- Folds for playback and storage

1375128

\$679⁹⁹ EA 

STIGA
STS185 TABLE

- 3/4" tournament blue top with silk screen lines
- 2" self opening steel legs
- 2" powder coated, steel apron with ball storage and corner protectors
- 3" mag wheels with sports tread tires, single sided swing arms and 2 locking wheels
- 72" pivoting net and post system with tension adjustments is integrated into the table to allow opening and closing without removing net
- Folds for playback and storage

1375127

\$579⁹⁹ EA 



OPTIMUM 30 TABLE

- First Table with a 30mm Thick Top
- Unparalleled Evenness and Ball Rebound
- Truest Possible Bounce
- 1.2" Blue Top with Table Top Connect System
- 2.4" Profiled Steel Apron
- 2.4" x 1.6" Steel Legs with Levelers
- 4" Machine Grade, Ball Bearing Casters with Locks
- Massive Chassis Construction
- Semi-Automatic Lock and Fold Design
- Compact Storage Position (60"W x 24"D x 62"H)
- Net and Post Included
- ITTF Approved

1309232

\$1,499⁹⁹ EA



CORONADO OUTDOOR TABLE

- Aluminum composite top
- Welded steel support frame
- 1 1/2" steel legs
- 4" all-terrain mag wheel casters
- Oversized composite caster beam
- Patented Quickplay™ chassis design
- Includes all-weather net and posts
- Molded corner protection pads with galvanized hardware
- Folds for playback and storage

1309225

\$699⁹⁹ EA



INSTA PLAY TABLE

- 3/4" Black top
- 2" steel support apron
- 2" square steel legs
- 3" ball bearing casters
- Heavy-duty chassis
- Includes 66" net and posts
- Corner pads for added protection
- Fully assembled - from box to play instantly
- Folds for playback and storage

1276176

\$589⁹⁹ EA



PREMIUM TABLE COVER

- Helps protect and prevent damage
- Heavy-duty woven PE material fits most tables
- Elastic hems provide a snug and secure fit in the vertical storage position
- 66 1/2"L x 61"W

90 Day Limited Warranty

1393110

\$61⁹⁹ EA



SENSOR SCORER

- The first and only hands-free, fully automated table tennis scoring system
- Innovative sensor technology turns the table top into a nano-vibration detection field
- Sensors attach under the table and communicate contact data to the scoring unit
- Tracks, displays and announces score and informs players when to change serve
- Universal mounting design installs in minutes

1388277

\$99⁹⁹ EA



STIGA
PREMIUM CLIPPER NET & POST SET

- Tournament-Level table tennis net and post set
- 72" premium cotton blend net and heavy-duty steel post
- Easy set-up and removal with spring-activated clip
- Precise tension adjustment with height measuring tool for regulation play
- Fits regulation-size tables (60"W) with up to 1" table thickness

90 Day Limited Warranty

1451392

\$39⁹⁹ SET

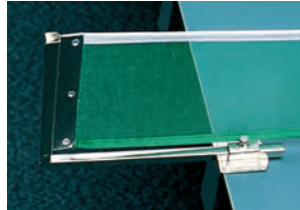

CHAMPIONSHIP NET AND POST SET

- Slip on, heavy-duty, open mesh polyethylene net (72" long)
- Heavy-duty posts with extended net clamps

NANP3XXX

\$23⁹⁹ SET ★



TOURNAMENT BALLS

- Seamless ball for championship play
- 3-star - 40mm - White

1035612 \$3⁰⁹ BOX OF 6 ★

1071160 \$62⁹⁹ GROSS OF 144 ★

RECREATIONAL BALLS

- Durable, all around ball
- 1-star - 40mm - White

1035605 \$2²⁹ BOX OF 6 ★

1071177 \$44⁹⁹ GROSS OF 144 ★

STIGA DELUXE BALLS

- Top quality game ball
- 2-star - 40mm - White

918XXXX \$69⁹⁹ GROSS OF 144



ORANGE RECREATIONAL BALLS

- Durable, all purpose ball
- 40mm - Orange for greater visibility

930 \$50⁹⁹ GROSS OF 144



UNISTRUCTURE PADDLES

- This is the one you can drive nails with
- One-piece paddle won't delaminate like wood paddles
- Looks like wood but will outlast wood

920E Simulated Sand Face \$4³⁹ EA ★

921E Rubber Face \$5⁰⁹ EA ★



PURE TABLE TENNIS RACQUET

- A Stiga 3 star product
- Concave handle with acrylic lens
- 5-ply rubber - 3-star rubber - 1.5mm sponge
- A great colorful racquet with unrivaled levels of power

90 Day Limited Warranty

Color Options: **Blue, Green, Pink, Yellow.**

1375146

Specify Color

\$31⁰⁹ EA



FLOW TABLE TENNIS RACQUET

- For indoor and outdoor play
- Designed to be weather and shock resistant
- Handle: Thermoplastic elastomers
- Face: Polypropylene and glass fibers

90 Day Limited Warranty

Color Options: **Black, Green.**

1375156

Specify Color

\$24⁴⁹ EA



PADDLES



ECONOMY SAND PAPER FACE

- Sand paper face

NAS1XXXX

5 ply

\$4⁰⁹ EA ★

ECONOMY RUBBER FACE

NAR1XXXX

5 ply

\$4⁵⁹ EA ★

STANDARD SPONGE RUBBER 2MM

NAR2XXXX

5 ply

\$5⁰⁹ EA ★

DELUXE SPONGE RUBBER 2MM

NAF2XXXX

5 ply

\$8¹⁹ EA ★



GLADIATOR FOOSBALL TABLE

- Tournament quality table that is built to last
- 15" deep MDF cabinet with 2" thick sidewalls
- 3/4" MDF playing surface
- 4 3/4" square post style legs with levelers
- 5/8" solid steel rods and traditional style men
- 34 3/4"H x 31 1/4"W x 56"L
- Includes 4 balls and integrated cup holders
- Weighs 180 lbs. - assembly required

1375117

\$659⁹⁹ EA



6 PACK OF FOOSBALLS

- Replacement foosballs
- 30 Day Limited Warranty**

1378324

\$10¹⁹ PACK



FOOSBALL PLAYERS W/HARDWARE

- 6 players including attachment hardware
- 90 Day Limited Warranty**
- Color Options: **Black, Red.**

1375152

Specify Color

\$15²⁹ PACK OF 6

SHUFFLEBOARD ACCESSORIES



SHUFFLEBOARD TABLE CLEANER & POLISH

- Removes dirt and produces high luster - 1 Qt.

NA7922XX

\$20⁹⁹ EA



SHUFFLEBOARD TABLE WEIGHTS

- 2" replacement weights
- 90 Day Limited Warranty**
- Color Options: **Blue, Red.**

1379364

Specify Color

\$7¹⁹ EA

SHUFFLEBOARD POWDER WAX

- Assures free-glide action, a must for table

NJ State Approved Co-op #65MCESCPS Metuchen/Garden State Appare

NA7924XX

\$13⁹⁹ EA

SHUFFLEBOARD TABLE



SHUFFLEBOARD TABLE

- Poly-Coated solid play surface for smooth, fast action
- Play area measures 14"W x 94 3/8"L
- Laminated cabinet and pedestal legs with levelers
- Abacus style scoring
- Includes 8 weights and 1 canister of wax
- Overall size: 31"H x 24 1/4"W x 108 1/4"L

1375124

220 lbs.

5/8/21

\$659⁹⁹ EA





MizeraK

DAKOTA 8' POOL TABLE

- 3/4" playbed
- Reinforced pedestal style legs with leg levelers
- 3 5/8" laminate top rails with full profile K66 nose rubber - provide uniform rebound and consistent play
- Wool blend cloth
- Features an internal ball return system
- Includes 2 cues, 1 set of balls, 1 triangle, chalk and table brush
- 31 1/4"H x 55"W x 99"L
- Assembly required

1375150 Slate - 683 lbs. **\$1,529⁹⁹** EA
 1375151 Slatron - 331 lbs. **\$1,259⁹⁹** EA



MizeraK

DONOVAN 8' POOL TABLE

- 3/4" playbed
- Reinforced pedestal style legs with leg levelers
- 3 5/8" Black laminate top rails
- Chrome corner posts and caps
- Full profile K66 cushions
- Deep Red wool/nylon blend cloth
- Internal drop pockets
- Includes 2 cues, 1 set of balls, 1 triangle, chalk and table brush
- 31 1/4"H x 55"W x 99"L
- Assembly required

1276497 Slate - 683 lbs. **\$1,329⁹⁹** EA
 1276503 Slatron - 331 lbs. **\$1,179⁹⁹** EA



MizeraK

DYNASTY 78" POOL TABLE

- Space saver design fits into smaller areas
- Attractive bamboo laminate
- Automatic ball return provides easy access
- Pedestal style legs with cross support for added stability
- Large disk style leg levelers for leveling made easy
- Sealed MDF playbed with durable nylon cloth
- Includes: 2 cues, 1 set of balls, 1 triangle and 2 pieces of chalk
- Assembly required

1375125 283 lbs. **\$689⁹⁹** EA



NEW!

TRIUMPH

TRIUMPH 84" POOL TABLE W/TT TOP

- Enjoy two 2 games in one – a strategic game of pool or an action-packed table tennis match
- Black finish table, green color cloth, and steel corner cap accents
- Table tennis conversion top comes equipped with 2 paddles, 2 balls, and net and post set
- Table tennis top features under-mount padding to protect the billiard cloth and rails below
- Billiard table includes 2 wood cues, ball set, triangle, brush, and chalk
- 31"H x 46 1/2"W x 84"L
- Assembly required

90 Day Limited Warranty

1398267 **\$499⁹⁹** EA



CLASSIC BUMPER POOL TABLE

- 49 1/2" x 33 1/2" play field
- 5 1/8" square legs
- 5 7/8" top apron and 7 3/4" bottom apron
- Constructed of MDF with wood grain laminate
- Accessories Included: 1 set of bumper pool balls, 2 (48") cues, chalk and brush
- Overall Dimensions: 32"H x 41 1/2"W x 57 1/2"L
- Assembly required

1375121 274 lbs. **\$639⁹⁹** EA



STIGA

POOL TABLE CONVERSION TOP

- Convert your pool table into a table tennis table
- Fits 7" and 8" pool tables
- 1/2" thick Dark Green wood top
- 30" center-mounted steel stiffeners
- Side strips help align top properly
- Sponge rubber strips hold top firmly in place
- Net and post sold separately

PREMIUM CLIPPER NET & POST SET

- Tournament-Level table tennis net and post set
- 72" premium cotton blend net and heavy-duty steel post
- Easy set-up and removal with spring-activated clip
- Precise tension adjustment with height measuring tool for regulation play
- Fits regulation-size tables (60"W) with up to 1" table thickness

2002081 **\$349⁹⁹** EA 1451392 **\$39⁹⁹** SET

Mizerak

BILLIARD STARTER KIT

- Includes 1 set of balls, 1 triangle, 1 table brush, 1 cue tip cement, assorted leather tips, ferrules, chalk, assorted table spots, sandpaper, trimmer and cue clamp

90 Day Limited Warranty

1393107

\$101⁹⁹ KIT



SOLID WOOD ONE-PIECE CUES

NAQ481XX	48"	\$14 ²⁹ EA ★
NAQ521XX	52"	\$15 ²⁹ EA ★

Weight: 17 oz., 19 oz., 20 oz., 21 oz..

NAQ57117	57" - Specify Weight	\$16 ⁹⁹ EA H
-----------------	----------------------	-------------------------

Screw-In Pool Cue Tips

- For wood and aluminum cues

NASCRTIP		\$12 ²⁹ DZN ★
-----------------	--	--------------------------



CHALK

NACHK122		\$5 ⁹⁹ BOX OF 12 ★
NACHK144		\$49 ⁹⁹ BOX OF 144 ★



Mizerak

MIZERAK SPIDER BRIDGE HEAD

- Provides 9 different shooting positions
- Slips onto any cue to convert to bridge cue
- Cues sold separately

90 Day Limited Warranty

1393111

\$6⁹⁹ EA

9-BALL RACK - PLASTIC

NATRPL9X		\$13 ²⁹ EA
-----------------	--	-----------------------



PLASTIC TRIANGLE 2 1/4"

NATRPLXX		\$10 ²⁹ EA ★
-----------------	--	-------------------------



MIZERAK BILLIARD TABLE BRUSH

- Clean and maintain your table
- Removes dust, dirt and debris from all types of cloth
- 9" hardwood handle with ultra-soft bristles

1393109		\$13 ²⁹ EA
----------------	--	-----------------------



REPLACEMENT CLOTH

- 85% Wool, 15% Nylon, 20 oz. Green cloth

NA232/7X	For 7' Bed Pool Table	\$147 ⁹⁹ EA
NA232/8X	For 8' Bed Pool Table	\$173 ⁹⁹ EA
NA232/9X	For 9' Bed Pool Table	\$187 ⁹⁹ EA
NA232/4X	For Bumper Pool Table	\$57 ⁹⁹ EA
NA233XXX	Cushion Cloth	\$82 ⁹⁹ EA
NA233/4X	Cushion Cloth For Bumper Table	\$70 ⁹⁹ EA



Mizerak

MIZERAK BILLIARD TABLE COVER

- Protects table against dust, fading and pills
- Heavy gauge, wrinkle resistant vinyl
- Fits tables up to 8' long

1393108

\$16²⁹ EA



8' AIR POWERED HOCKEY TABLE

- Commercial grade blower maximizes air-flow eliminating dead spots
- Super slick, scuff resistant melamine surface for fast, smooth play
- Hide-away LED scoreboard with oversized numbers
- Solid 6" square leg posts with leg levelers for added stability
- Includes 4 strikers and 4 pucks
- Some assembly required
- 32"H x 50"W x 96"L - Weight: 400 lbs.

1296266

\$1,489⁹⁹ EA



BLAZER 7' AIR POWERED HOCKEY TABLE

- Heavy-duty 120V blower motor
- 3/4" gloss PVC laminated playing surface
- 4 1/2" MDF aprons
- Overhang rails to reduce puck bounce
- 6" pedestal style legs with 5" leg levelers
- Flip-up electronic scoring
- Includes (4) strikers and (4) 3" pucks
- Assembly required
- 32"H x 48"W x 84"L - Weight: 190 lbs.

1375118

\$669⁹⁹ EA



NEW!



TRIUMPH LUMEN-X 6' HOCKEY TABLE

- Interactive table features in-rail LED lighting with cascading effects and in-game music
- Includes: two ultra-bright strikers and light-up puck
- Enjoy fast and furious game play as dual motor blowers provide continuous air flow
- Easily keep track of the action without losing focus with electronic scoring
- Assembly required
- 31"H x 40"W x 72"L - Weight 99 lbs.

90 Day Limited Warranty

1398266

\$449⁹⁹ EA

7' FLIP TABLE

- Billiard Table - simply flip the top over - and you have an Air-Powered Hockey Table
- New locking mechanism - locks table top securely in place
- Billiard Table - high density MDF playbed
- Red nylon blend cloth
- Hockey Table - glossy PVC laminate playbed with 110V blower motor
- 3" solid rails and heavy-duty aprons
- 4 1/2" boxed and tapered legs with levelers
- Manual inlaid scoring
- Includes: 2 cues (48"L), 1 set of billiard balls, 1 rail brush, 1 triangle, 2 chalk, 2 strikers and 2 pucks
- Assembly required
- 32"H x 44"W x 96"L - Weight: 400 lbs.



1378531

\$849⁹⁹ EA



TABLE HOCKEY ACCESSORIES

- Strikers and pucks for air powered hockey tables
- Colors vary

NA6107XX
1402XXXX
1403XXXX

2 Strikers & 2 (2 1/2") Pucks
5 (2 1/2") Pucks
2 Strikers

\$18⁹⁹ SET OF 5 ★
\$14²⁹ SET OF 5 ★
\$12²⁹ SET OF 2 ★

Bid #ESCNJ 17/18-31

Educational Services Commission of New Jersey

Athletic Equipment & Supplies

GAME TABLES



ECONOMY CARROM® BOARD

- 28" W x 28" L wood frame with corner pockets
- Two-sided board plays 100+ games including Checkers, Carroms and Billiards
- Includes 44 playing pieces, 2 cues, number discs and instructions
- For ages 13 and up

2850XXXX \$91.89 SET

REPLACEMENT CARROMS® SET

- Complete set of replacement equipment, excluding cues

2852XXXX \$19.99 SET



POCKET GOLF GAME BOARD

- 34" W x 50" L hardwood frame with steel corners
- Colorful silk-screened, coated surface
- Includes two 36" cue sticks and set of carroms®
- Up to 4 players enjoy all the excitement of real golf including sand traps and water hazards
- Recommended for ages 7 and up

HM12500XBM \$229.99 EA ★
HM11004X \$7.99 SET OF 4 ★
 Extra Playing Pieces



HEAVY DUTY MULTI-GAME BOARD

- 28 1/2" x 28 1/2" maple hardwood side rails, birch plywood playing surface and cast aluminum pockets
- Comes with two 24" hardwood cue sticks and 26 playing pieces
- Recommended for ages 7 and up

HM11000XBM \$163.99 EA ★
HM11002XBM \$20.99 SET OF 26 ★
 Extra Playing Pieces



DOUBLE SHOT BASKETBALL GAME

- The ultimate arcade style shootout for casual use
- Each goal equipped with infrared eyes for enhanced scoring accuracy
- Two player scoring and timing
- Heavy-duty MDF backboard and nylon netting
- Rectangular steel tube cage adds support and stability
- Includes 4 mini balls and inflator
- 88" H x 47" W x 89" L
- Weight: 200 lbs.

90 Day Limited Warranty
 1375122 \$579.99 EA



DELUXE SHOOT OUT

- Designed for casual use
- Each goal equipped with infrared eyes
- Frame is 1 1/4" steel tubing
- Two player electronic scoring and timer
- Includes 4 mini basketballs and pump
- 89" H x 45" W x 106" L

90 Day Limited Warranty
 1378530 \$249.99 EA

GAMEBOARD ACCESSORIES

GAME BOARD ACCESSORIES

90 Day Limited Warranty

HM10360XBM 36" Cue Stick \$23.99 PR ★
NA7924XX Powder Wax \$12.99 EA



QUADPODS

- Perfect for table top games
- Strong 1" steel legs pivot on steel pins mounted in the center block
- Rubber-tipped legs protect floor
- Folds and stores easily - weight: 9 lbs. - 36" tall
- For games 30" x 30" or larger (game not included)

QUADPOD LEG ASSEMBLY SOLD SEPARATELY. NOT INCLUDED WITH TABLE TOP GAMES.



Bid #ESC/NJ 17/18-31

Educational Services Commission of New Jersey

Athletic Equipment & Supplies



STANDARD PLAYING CARDS

- Plastic coated, linen finish
- Packed per dozen
- Half Blue and half Red

NAPC-1XX Poker \$28.99 DZN ★
NAPC-2XX Pinochle \$28.99 DZN ★



CHESS/CHECKERS/BACKGAMMON SET

- Three classics in one box!
- Double sided game board, 30 plastic checkers, Staunton chess pieces, dice and instructions
- For 2 players, ages 8 and up

1238228 \$12.99 EA



CHECKERS SET

- 15" x 15" folding board
- (24) 1 1/4" checkers

NA637XXX \$8.29 EA



PUZZLES - 1000 PIECES

- 6 puzzles with 3 assorted scenes
- All 3 scenes are duplicated (total of 6)

1369717 \$37.99 PACK OF 6

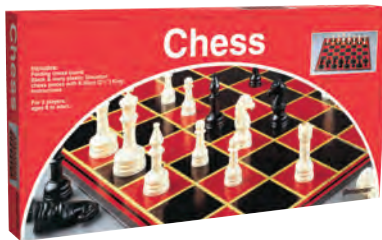

CHESS SET

- 15" x 15" folding board
- (32) plastic chess pieces

2261XXXX \$8.99 SET



ECONOMY BACKGAMMON

- 15" x 15" folding board
- Includes 30 playing pieces, 2 pair of dice, and instructions
- For 2 players ages 7 and up

2245XXXX \$10.99 EA



NEW!

ECONOMY BINGO SET

- Features a plastic cage on a sturdy base with ball track
- Includes tally card, plastic balls, 21 bingo cards, 100 markers and instructions
- For 2 or more players ages 7 and up

1244342 \$27.99 EA



UNO CARD GAME

- Yell UNO! when you have only one card left
- America's #1 card game
- Includes 108 cards
- 2 to 10 players ages 7 and up

4036XXXX \$11.29 EA



WOOD CRIBBAGE GAME

- Players use card combinations to peg points along the wood board
- Includes wood cribbage board with storage compartment, compartment cover, 9 pegs, deck of cards and instructions
- For 2 or 3 players, ages 8 and up

1244335 \$12.99 EA



DELUXE DOUBLE-SIX DOMINOES SET WITH CASE

- 28 jumbo crystalline dominoes, vinyl case and rules
- For 2 to 4 players ages 7 and up

1238211 \$16.99 EA



DOUBLE-SIX DOMINOES

- 28 solid, hardwood dominoes

2240XXXX \$6.99 EA



DOUBLE-NINE DOMINOES

- 55 large, solid hardwood dominoes

2552XXXX \$8.99 EA



DELUXE TRI-OMINOS

- The classic triangular domino game
- Score points by matching numbers on the three sided tiles with brass spinners

2302XXXX \$23.99 EA



BATTLESHIP
 • Plan your strategy and sink your opponent's ships
 • For 2 players ages 7 and up
4020XXXX \$30⁹⁹ EA



CANDYLAND
 • Classic beginner game
 • For 2-4 players ages 3-6
4019XXXX \$18⁹⁹ EA



CHUTES AND LADDERS
 • Up the ladders and down the chutes
 • For 2-4 players ages 3-7
4018XXXX \$16⁹⁹ EA



CONNECT 4
 • Five games in one
 • For 2 players ages 7 and up
4071XXXX \$27⁹⁹ EA



JENGA
 • Keep the tower from falling
 • For 1 or more players ages 6 and up
4793XXXX \$24⁹⁹ EA



MONOPOLY
 • The classic game of buying and selling
 • For 2 to 8 players ages 8 and up
4034XXXX \$30⁹⁹ EA
1371283 Monopoly Deal Card Game \$8⁹⁹ EA



OPERATION
 • You get to be the doctor and make Cavity Sam better or get the buzzer
 • For 1 or more players ages 4 and up
4078XXXX \$29⁹⁹ EA



RISK
 • Rally your armies to march across continents
 • Keep advancing until you've taken over the world!
 • For 2 to 5 players ages 10 and up
4037XXXX \$49⁹⁹ EA



SCRABBLE
 • Classic crossword game
 • For 2 to 4 players ages 8 and up
4044XXXX \$30⁹⁹ EA
1371282 Scrabble Slam Card Game \$8⁹⁹ EA



SORRY!
 • Bump, slide and switch until somebody gets all the way home
 • For 2 to 4 players ages 6 and up
4042XXXX \$31⁹⁹ EA



TRIPOLEY DELUXE
 • A fast-paced, 3-in-1 challenge in which players use a single card hand to play a round of Michigan Rummy, Hearts and Poker
 • Flip the felt mat over to play a game of Texas Hold'em
 • Includes: 100 chips, two-sided deluxe felt mat, deck of cards and English/Spanish instructions
 • For 2 to 9 players ages 8 and up
1255713 \$20⁹⁹ EA



YAHITZEE
 • Throw the dice to build straights, full houses, 5 of a kind - Yahtzee
 • For 1 or more players ages 8 and up
4024XXXX \$16⁹⁹ EA
4025XXXX 80 Replacement Score Cards \$6⁰⁹ EA

Mancala	2401XXXX	\$19 ⁹⁹ EA
Clue	4038XXXX	\$30 ⁹⁹ EA
Monopoly Junior	4919XXXX	\$22 ⁹⁹ EA
Game of Life	4011XXXX	\$32 ⁹⁹ EA
Memory	4073XXXX	\$16 ⁹⁹ EA
Guess Who	1359455	\$20 ⁹⁹ EA

Perfection	1160000	\$15 ⁹⁹ EA
Rook	4714XXXX	\$9 ²⁹ EA
Scrabble Dictionary	4915XXXX	\$11 ⁹⁹ EA
Trouble	4023XXXX	\$21 ⁹⁹ EA
Twister	4072XXXX	\$31 ⁹⁹ EA



LOCKERS

Standard Locker Features

- HD steel, electrically welded frame construction
- Powder coat baked enamel finish
- 1" steel top and bottom channels
- Recessed handles (ADA compliant)
- Full loop 5-knuckle design hinges welded to door frame, securely riveted to doors
- Ventilating louvers
- Coat hooks
- Number plates (up to four numerals)
- 6" legs
- Shipped unassembled with complete instructions

1. SINGLE TIER

72"H x 12"W x 18"D (size of opening)

1053210	3 Wide - 3 Openings	\$559 ⁹⁹	SET OF 3	
1053371	1 Wide - 1 Opening	\$239 ⁹⁹	EA	

2. DOUBLE TIER

36"H x 12"W x 18"D (size of opening)

1053531	3 Wide - 6 Openings	\$659 ⁹⁹	SET OF 6	
1053692	1 Wide - 2 Openings	\$279 ⁹⁹	EA	

3. MULTI TIER

12"H x 12"W x 12"D (size of opening)

1053852	3 Wide - 18 Openings	\$709 ⁹⁹	SET OF 18	
1054019	1 Wide - 6 Openings	\$309 ⁹⁹	EA	

24 Designer Colors

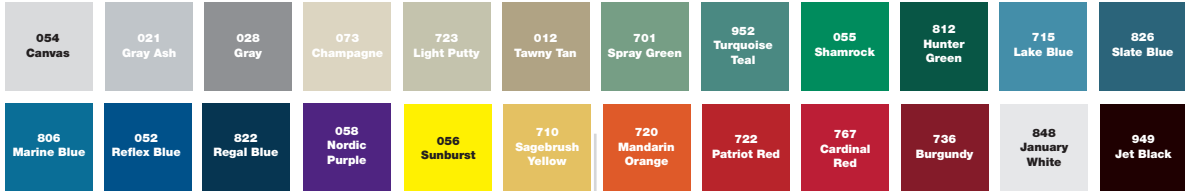

STADIUM LOCKERS®

- Ideally suited for athletic team rooms or anywhere easy access to uniforms and/or equipment is required
- Open front and visually perforated sides create full ventilation
- Made from prime grade mild cold rolled sheet steel, powder coat finish and painted the same color inside and out
- 72"H x 24"W with your choice of 18" or 24" depths and 4 different configurations

72"H x 24"W x 18"D

1246186	With Shelf	\$389 ⁹⁹	EA	
1246391	With Shelf and Security Box	\$419 ⁹⁹	EA	
1246735	With Shelf and Footlocker	\$539 ⁹⁹	EA	
1246940	With Shelf, Footlocker and Security Box	\$639 ⁹⁹	EA	

72"H x 24"W x 24"D

1247152	With Shelf	\$429 ⁹⁹	EA	
1247367	With Shelf and Security Box	\$529 ⁹⁹	EA	
1247572	With Shelf, Footlocker and Security Box	\$689 ⁹⁹	EA	

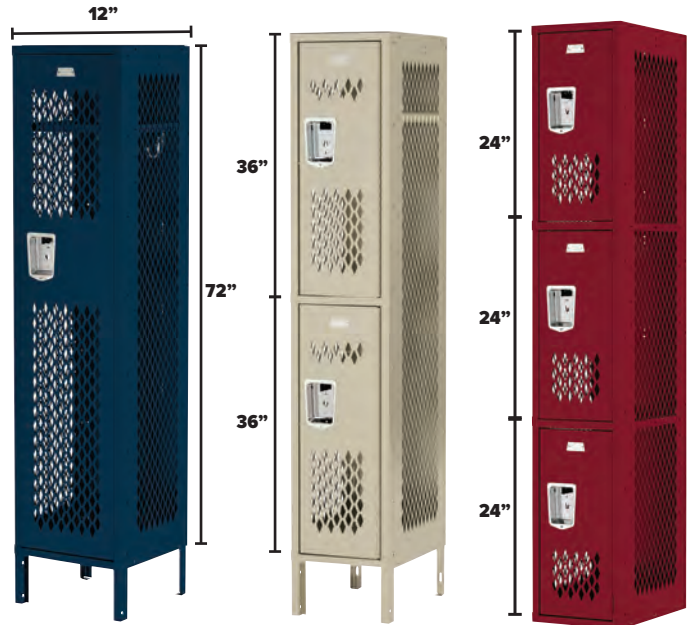

ATHLETIC LOCKERS

- Constructed from heavy gauge steel
- Doors and sides are perforated allowing maximum air circulation while maintaining security
- Includes a stainless steel recessed handle and multi-point latching
- Lockers can be built in small groups and then placed into long rows
- To end a group or row of lockers, order either a perforated or solid 16 gauge group end (for solid group ends on lockers with common perforated sides, be sure to order a solid end for each row end)
- All units are 72"H x 12"W x 18"D

1215656	Single Tier	\$299 ⁹⁹	EA	
1215854	Double Tier	\$349 ⁹⁹	EA	
1216059	Triple Tier	\$389 ⁹⁹	EA	
1216259	Perforated End	\$189 ⁹⁹	EA	
1216455	Solid End	\$129 ⁹⁹	EA	

Bid #ESCNJ 17/18-31

Educational Services Commission of New Jersey

Athletic Equipment & Supplies

Master Lock

BlockGuard Anti-Shim Technology

- Unique flat latch technology that actually blocks typical shimmying tools from opening the lock – deterring break-ins
- Hardened steel shackle resists cutting and prying
- Double-reinforced stainless steel case with cold-rolled steel construction shields locking mechanism from physical attack
- Thousands of possible combinations
- Dial automatically locks under shackle tension to prevent “feeling out” of combination
- Combination automatically scrambles when closed to prevent accidental opening
- Fits lockers with a padlock eye of at least 5/16” (8 mm) diameter



	DESCRIPTION	LOCK TYPE	CASE	SIZE	CODE	PRICE
1.	Padlock	Keyed alike, all-purpose double locking shackle with 2 brass keys	Solid body construction, brass cylinders	1-9/16” wide, 3/4” tall and 9/32” dia. shackle, 3/4” clearance	20027893	\$13 ⁹⁹ EA
2.	Combination lock - keyless	Combination - no keyway	Stainless steel body, black dial	1-7/8” wide body, 3/4” tall hardened steel shackle	20021502	\$8 ⁹⁹ EA
3.	Combination lock 1525 (Specify color/series)	Keyed alike combination locks (Keys sold sep.)	Stainless Steel body, Specify Color and Keyway	1-7/8” wide body, 3/4” tall hardened steel shackle	MSL1525	\$10 ⁹⁹ EA
4.	Combination lock-Keyed alike V69 Series	Keyed alike combination locks (Keys sold sep.)	Stainless Steel Body, Black, Blue, Green or Red Dial	1-7/8” wide body, 3/4” tall hardened steel shackle	1022858	\$10 ⁹⁹ EA
5.	Control keys - specify keyway				20029474	\$5 ⁹⁹ EA

LOCKS & LOCKERS

WADDELL

a GMI company

TROPHY CASES

- Classic styled, durable, hardwood cases
- Sliding tempered glass doors, built-in locks and levelers, white laminate backs and the full length is available with an optional cornice light fixture
- Available finishes: Cordovan, Danish Walnut or Honey Maple (Oak finish is available for an extra charge)
- Free remembrance plaque (not engraved) also available on request
- Mirrored or plaque fabric backs are available for an extra charge
- Overall measurements include a 10” base
- Light fixture adds 6” to height of 70” case

PTA949XX	40”H x 36”W x 14”D - 112 lbs.	\$899 ⁹⁹ EA	
3421XXXX	70”H x 48”W x 18”D - 243 lbs.	\$1,879 ⁹⁹ EA	
PTA8931X	Light Fixture For 70”H Case	\$419 ⁹⁹ EA	



WADDELL

a GMI company

SPIRIT DISPLAY CASE

- Display all of your achievements in these vibrant color cases
 - Anodized aluminum framing with a 12” base cabinet
 - Features sliding tempered glass doors and (4) 14” deep half shelves with brackets
 - Built-in locks and levelers
 - 72”H x 16”D
 - Optional cornice/lighting fixture available in 10 colors
 - Please specify color of frame, base and back panel
- Backing Color Options: **Plaque, White**
 Base Color Options: **Black, Forest Green, Gold, Kelly Green, Maroon, Navy, Orange, Purple, Red, Royal**
 Frame Color Options: **Bronze, Gold, Satin.**

1364410	1) 48”W Display Case	\$2,099 ⁹⁹ EA	
1364470	2) 60”W Display Case	\$2,399 ⁹⁹ EA	
1364630	48”W Cornice/Lighting Fixture	\$389 ⁹⁹ EA	
1364640	60”W Cornice/Lighting Fixture	\$449 ⁹⁹ EA	



BULLETIN BOARD

- Satin aluminum frame
- 36”H x 48”W with natural cork display area
- Includes 2 key lock shatter-resistant acrylic doors

1162806

\$479⁹⁹ EA



HEAVY DUTY RECTANGULAR TABLE

- 6', 8', 10' and 12' lengths available
- 2-3/8" diameter all welded frame with powder coat finish
- Diamond and Perforated patterns available
- 1 or 2 sided ADA 8' versions
- Table is both Portable and Surface Mount (mounting hardware not included)

5 Year Limited Warranty



WIDE WALK THROUGH DESIGN FOR EASY ENTRY & EXIT



SIZE	STYLE	DIAMOND	PERFORATED	PRICE EA.	DELIVERY
6'	Walk-thru	1275353	1275360	\$1,107 ⁹⁹	
8'	Walk-thru	1275377	1275384	\$1,212 ⁹⁹	
8' ADA	Double sided	1275438	1275445	\$1,107 ⁹⁹	
8' ADA	Single sided	1275452	1275469	\$1,107 ⁹⁹	
10'	Walk-thru	1275391	1275407	\$1,559 ⁹⁹	
12'	Walk-thru	1275414	1275421	\$1,634 ⁹⁹	

THE THERMOPLASTIC ADVANTAGE!

- High thermal stability keeps seats and tables cooler
- More corrosion and rust-resistant than other coatings
- Products are more durable and last longer
- FDA approved non-stick surface confidence in user safety for food contact



46" SQUARE AND ROUND TABLES

- 1-5/8" diameter steel frame with powder coat finish
- Diamond and Perforated patterns available
- Portable and/or Surface Mount (mounting hardware not included)
- Includes center umbrella hole

5 Year Limited Warranty



Square

SIZE	STYLE	DIAMOND	PERFORATED	PRICE EA.	DELIVERY
46"	Square	1275476	1275483	\$1,107 ⁹⁹	
46"	Round	1275490	1275506	\$1,159 ⁹⁹	

RECTANGULAR PEDESTAL TABLE

- 4' and 6' lengths available
- Heavy-duty 4" square steel center post
- 3" square steel support arm posts
- Diamond and Perforated patterns available
- In-Ground or Surface Mount
- ADA compliant

5 Year Limited Warranty



In-Ground

SIZE	PATTERN	IN-GROUND	SURFACE MOUNT	PRICE EA.	DELIVERY
4'	Diamond	1275513	1275520	\$1,159 ⁹⁹	
4'	Perforated	1275537	1275544	\$1,318 ⁹⁹	
6'	Diamond	1275551	1275568	\$1,350 ⁹⁹	
6'	Perforated	1275575	1275582	\$1,455 ⁹⁹	

THERMOPLASTIC & POWDER COAT COLOR OPTIONS:

Tables, benches & receptacles feature rounded corners with either diamond expanded or perforated pattern. All items can be coated with any color shown here.

NJ State Approved Co-op #65MCESCCPS Metuchen/Garden State AppareBid Term: 5/9/18 - 5/8/20: Extended to 5/8/21

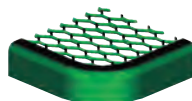

DIAMOND EXPANDED

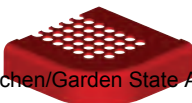

PERFORATED

- BLACK
- BROWN
- GREEN
- DARK BLUE
- BURGANDY
- BLUE
- RED



Bid #ESCNJ 17/18-31

Educational Services Commission of New Jersey

Athletic Equipment & Supplies

HEAVY DUTY PICNIC TABLES

- 6' and 8' lengths available
- 2-3/8" diameter all welded walk through frame
- Pressure treated pine or aluminum plank options available
- 1 or 2 sided ADA 8' versions
- Pre-drilled holes for Portable and Surface Mount (mounting hardware not included)
- Made in the USA



SIZE	STYLE	PRESSURE TREATED		ALUMINUM	
		PRICE	PRICE	PRICE	PRICE
6'	Walk-thru	1275995	\$632 ⁹⁹	1276039	\$1,030 ⁹⁹
8'	Walk-thru	1276008	\$685 ⁹⁹	1276046	\$1,134 ⁹⁹
8' ADA	Double sided	1276015	\$685 ⁹⁹	1276053	\$1,134 ⁹⁹
8' ADA	Single sided	1276022	\$685 ⁹⁹	1276060	\$1,134 ⁹⁹



1275629 - 8' PERFORATED PORTABLE BENCH WITH PUNCHED CUSTOM LETTERING

THERMOPLASTIC BENCHES W/CUSTOM LETTERING

- Benches can be customized with either punched or laser-cut lettering for a specialized look
 - Available colors: Black, Brown, Green, Dark Blue, Burgundy, Light Blue, Red and Beige
 - Call for lettering details
- 5 Year Limited Warranty**

SIZE	PORTABLE	IN-GROUND	SURFACE MOUNT	PRICE EA.	DELIVERY
6'	1275599	1275605	1275612	\$892 ⁹⁹	
8'	1275629	1275636	1275643	\$945 ⁹⁹	

*Price includes custom lettering



LASER CUT LETTERING
1275667 - 5' LEXINGTON WAVE BENCH

ENTIRE BENCH (FRAME INCLUDED)
AVAILABLE ONLY IN ONE THERMOPLASTIC FINISH

LEXINGTON WAVE BENCH

- Customized bench for a specialized look
 - Custom lettering is included
 - 12 letter spaces maximum for 4' benches
 - 18 letter spaces maximum for 6' benches
- 5 Year Limited Warranty**

1275650	4' Portable and/or Surface Mount	\$1,470 ⁹⁹ EA	
1275667	6' Portable and/or Surface Mount	\$1,680 ⁹⁹ EA	

ULTRACOAT™ THERMOPLASTIC COATED BENCHES

- 6' and 8' lengths available
 - 12" wide seat
 - Diamond and Perforated patterns available
 - All welded frame made from 2-3/8" O.D. pipe
 - Made in the USA
- 5 Year Limited Warranty**



6' BENCH WITH BACK - DIAMOND

BENCH WITH BACK SUPPORT					
SIZE	PORTABLE	IN-GROUND	SURFACE MOUNT	PRICE EA.	
6' DIA.	1275759	1275797	1275834	\$739 ⁹⁹	
6' PERF.	1275766	1275803	1275841	\$791 ⁹⁹	
8' DIA.	1275773	1275810	1275858	\$813 ⁹⁹	
8' PERF.	1275780	1275827	1275865	\$844 ⁹⁹	



6' BENCH - PERFORATED

BENCH WITHOUT BACK SUPPORT					
SIZE	PORTABLE	IN-GROUND	SURFACE MOUNT	PRICE EA.	
6' DIA.	1275872	1275919	1275957	\$474 ⁹⁹	
6' PERF.	1275889	1275926	1275964	\$515 ⁹⁹	
8' DIA.	1275896	1275933	1275971	\$515 ⁹⁹	
8' PERF.	1275902	1275940	1275988	\$566 ⁹⁹	

NJ State Approved Co-op #65MCESCPCS, Metuchen/Garden State Apparatus Bid Term: 5/9/18 - 5/8/20: Extended to 5/8/21

PARKS



ROTATING FLIPBACK GRILL

- 280 sq. inches of cooking area
- Cool coil handles
- Adjustable to 4 different levels
- Easy cleanup and fire building
- High temp. powder coat finish
- Mounts in-ground

1276077	2-3/8" Post	\$268 ⁹⁹ EA	S&H
1276084	3-1/2" Post	\$339 ⁹⁹ EA	S&H



ADA ACCESSIBLE GRILL

- Same specs. as Rotating Flipback Grill
- 3-1/2" post
- ADA accessible at 28" height

1276091	280 sq. inch Cooking Area	\$268 ⁹⁹ EA	S&H
1276107	300 sq. inch Cooking Area	\$288 ⁹⁹ EA	S&H



BI-LEVEL GRILL

- 1008 square inches of cooking area
- Utility shelf, grate adjusts to 4 different levels
- 4" square post
- High temp. powder coat finish

1276114	In-Ground	\$824 ⁹⁹ EA	S&H
1276121	Surface Mount	\$876 ⁹⁹ EA	S&H

KENSINGTON PREMIUM SERIES

- Includes a bench, bench without back, single pedestal table, 3 seat round table and side-load receptacle
- This series is all steel construction with powder coat finish
- Features rolled vertical slats that are 1 1/2" x 1/4" flat steel precision formed
- The legs are made of 2 7/8" twelve gauge steel
- The benches are available in surface mount and in-ground mount
- Receptacle includes a solid top lid and 32 gallon liner
- The single pedestal table is supported by a 4" x 4" eleven gauge structural steel tubing and is available in surface mount or in-ground mount
- Assembly required
- Available colors: Beige, Black, Blue, Brown, Burgundy, Dark Grey, Green, Matte Black Metallic, Purple, Red, Ultra Blue Metallic, White and Yellow



1393456	46" Square Table - Surface Mount	\$2,886 ⁹⁹ EA	S&H
1393457	46" Square Table - In-Ground Mount	\$2,886 ⁹⁹ EA	S&H
1393458	46" 3 Seat Round Table	\$2,092 ⁹⁹ EA	S&H
1393459	6' Bench w/Back - Surface Mount	\$1,577 ⁹⁹ EA	S&H
1393460	6' Bench w/Back - In-Ground Mount	\$1,536 ⁹⁹ EA	S&H
1393461	6' Bench wo/Back - Surface Mount	\$1,237 ⁹⁹ EA	S&H
1393462	6' Bench wo/Back - In-Ground Mount	\$1,195 ⁹⁹ EA	S&H
1393463	32 Gallon Receptacle	\$1,051 ⁹⁹ EA	S&H

POWDER COAT COLOR OPTIONS:



PIONEER GRILL

- A great all around campfire grill
- Four strong support bars combined with chrome plated, thick gauged steel wire
- Permanently attached and rigidly braced legs fold flat
- 12 1/2"W x 24"L with 12" legs
- Must order in increments of 6 each

1376522	\$24 ⁹⁹ EA
---------	-----------------------



CAMPFIRE RING & GRILL

- A combination grill and fire ring
- Coil grip handles allow easy movement of the sliding grill for heat control and fire building
- The non-removable grill is made of 1/2" round bars on 1 1/8" centers
- Cooking surface is 15 1/2" x 18 1/2" providing 286 square inches
- The fire box and fire ring are made of 3/16" steel
- Fire box measures 21"W x 10"H x 15"D

1376524	79 lbs.	\$199 ⁹⁹ EA
---------	---------	------------------------

Bid #ESCNJ 17/18-31

Educational Services Commission of New Jersey Athletic Equipment & Supplies

THERMOPLASTIC TRASH RECEPTACLES

- 32 gallon trash receptacle is available in Diamond or Perforated patterns.
- Plastic liner and lids sold separately.
- Available colors: Black, Brown, Green, Dark Blue, Burgundy, Light Blue, Red and Beige.

5 Year Limited Warranty

1275698	Diamond - Specify Color	\$399 ⁹⁹ EA	
1275704	Perforated - Specify Color	\$515 ⁹⁹ EA	
1275711	Dome Lid - Black	\$159 ⁹⁹ EA	
1275728	Flat Lid (8" Opening) - Specify Color	\$159 ⁹⁹ EA	
1275735	Rain Bonnet - Specify Color	\$199 ⁹⁹ EA	
1275742	Plastic Liner - Black	\$84 ⁹⁹ EA	



32 GALLON CUSTOM LASER CUT TRASH RECEPTACLE

CUSTOM TRASH RECEPTACLES

1275674	Diamond Pattern	\$679 ⁹⁹ EA	
1275681	Perforated	\$837 ⁹⁹ EA	



DOMELID



RAIN BONNET LID



32 GALLON TRASH RECEPTACLE - PERFORATED

32 GALLON TRASH RECEPTACLE - DIAMOND

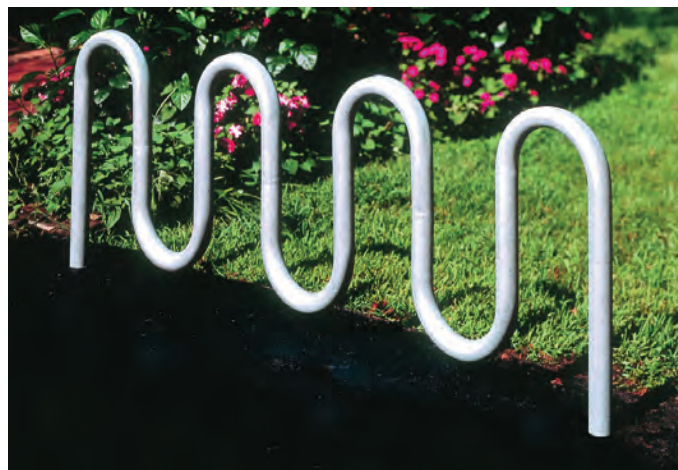

CONTEMPORARY BIKE RACKS

- All one piece - no assembly required
- Comprised of 2 3/8"OD steel tubing
- Available as in ground design or surface mount (mounting hardware not included)

7 loop Bike Rack

5 Year Limited Warranty

1375247	1 Loop - 2 Bike - In ground design	\$226 ⁹⁹ EA	
1375249	1 Loop - 2 Bike - Surface mount design	\$247 ⁹⁹ EA	
1375250	3 Loop - 5 Bike - In ground design	\$484 ⁹⁹ EA	
1375251	3 Loop - 5 Bike - Surface mount design	\$546 ⁹⁹ EA	
1375252	5 Loop - 7 Bike - In ground design	\$556 ⁹⁹ EA	
1375253	5 Loop - 7 Bike - Surface mount design	\$608 ⁹⁹ EA	
1375254	7 Loop - 9 Bike - In ground design	\$628 ⁹⁹ EA	
1375255	7 Loop - 9 Bike - Surface mount design	\$680 ⁹⁹ EA	
1375256	9 Loop - 11 Bike - In ground design	\$824 ⁹⁹ EA	
1375257	9 Loop - 11 Bike - Surface mount design	\$876 ⁹⁹ EA	

TRADITIONAL BIKE RACKS

- Available as either in-ground, portable or surface mount design (mounting hardware not included)
- Constructed of 1 5/8"OD steel
- 5/8"OD rung bars
- All zinc plated hardware

5 Year Limited Warranty

1375258	5' Single sided - In ground	\$494 ⁹⁹ EA	
1375259	5' Single sided - Portable	\$474 ⁹⁹ EA	
1375260	5' Single sided - Surface Mount	\$536 ⁹⁹ EA	
1375261	8' Single sided - In ground	\$566 ⁹⁹ EA	
1375262	8' Single sided - Portable	\$546 ⁹⁹ EA	
1375263	8' Single sided - Surface Mount	\$608 ⁹⁹ EA	
1375264	10' Single sided - In ground	\$628 ⁹⁹ EA	
1375265	10' Single sided - Portable	\$608 ⁹⁹ EA	
1375266	10' Single sided - Surface Mount	\$670 ⁹⁹ EA	
1375267	5' Double sided - In ground	\$525 ⁹⁹ EA	
1375268	5' Double sided - Portable	\$505 ⁹⁹ EA	
1375269	5' Double sided - Surface Mount	\$546 ⁹⁹ EA	
1375270	8' Double sided - In ground	\$628 ⁹⁹ EA	
1375271	8' Double sided - Portable	\$608 ⁹⁹ EA	
1375272	8' Double sided - Surface Mount	\$670 ⁹⁹ EA	
1375273	10' Double sided - In ground	\$742 ⁹⁹ EA	
1375274	10' Double sided - Portable	\$721 ⁹⁹ EA	
1375275	10' Double sided - Surface Mount	\$773 ⁹⁹ EA	



5' DOUBLE-SIDED BIKE RACK

HITCH POST BIKE RACKS

- Classic Bollard style rack for settings tight on space
- Capacity up to two bikes
- 36"H x 20"W
- 2 3/8"OD 12 gauge galvanized steel tubing
- Rings are 1 5/16" 14 gauge zinc tubing

5 Year Limited Warranty

1375276	In-ground	\$201 ⁹⁹ EA	
1375277	Surface Mount	\$211 ⁹⁹ EA	



HORSESHOE BIKE RACKS

- Blends elegance with practicality
- Capacity up to two bikes
- 37"H x 42"W
- Framework is 1.9"OD - 11 gauge galvanized steel tubing

5 Year Limited Warranty

1375278	In-ground	\$412 ⁹⁹ EA	
1375279	Surface Mount	\$453 ⁹⁹ EA	





WIRELESS CONTROLLER



OPTIONAL STAND
(SOLD SEPARATELY)

MacGregor

4' X 2' MULTISPORT INDOOR SCOREBOARD

- 6" LED numerals with 3 digit scoring, digital periods, bonus and possession indicators, (fouls can be kept on controller) last minute counts down in 1/10th seconds
- Durable plastic cabinet with plexiglass face
- Scores basketball, volleyball, wrestling and can function as a stopwatch or clock
- Includes rechargeable wireless remote control with 300' range and 12 frequency settings to help eliminate wireless interference
- Controller changes sports easily and can turn scoreboard on and off remotely
- Built in wall mount slots or use with portable stand (sold separately)
- Includes 100' of data cable if cable connection is preferred
- Weight: 24 lbs.
- Assembled stand measures 60"H x 56"W x 31"D

\$999⁹⁹

SK3048 ★ Complete Unit

OPTIONS		
1317107	Optional Stand	\$199 ⁹⁹ EA ★
1375095	Replacement Remote	\$199 ⁹⁹ EA ★



COUNT DOWN TO GAME DAY CLOCK

- Count down to game time in Days, Hours, Minutes and Seconds
- 2-1/4" bright LED digits for easy viewing
- Quick and easy set up
- Change out customer supplied graphics for each event
- Hinged front window allows for easy access to event panel
- Graphics window size - 26"W x 11"H

1388090

Cabinet Size - 28"W x 22"H

\$399⁹⁹ EA ★



SIDE CONTROL PANEL



CABINET OPEN



OPTIONAL STAND
(SOLD SEPARATELY)



1. INDOOR TABLETOP SCOREBOARD

- Dimensions: 16"H x 24"W x 10"D - 13 lbs.
- LED clock digits: 4.75" , LED score digits: 4.25"
- Scores basketball, volleyball and wrestling and can function as a metronome, stopwatch, clock with alarm and program timer
- Included wireless remote (100' range) allows operator to change score and start/stop the clock
- 4 user-programmable frequency settings for operating multiple units independently in the same area
- Includes digital periods, bonus, team fouls and possession indicators
- Indoor use only
- Optional assembled stand measures 43"H x 28"W x 28"D

SK2229R Indoor Tabletop Scoreboard **\$499⁹⁹** EA ★

OPTIONS		
1293784	Wheeled Stand	\$99⁹⁹ EA ★
1240597	Extra Loud Horn	\$63⁹⁹ EA ★
1142266	Carry Bag	\$74⁹⁹ EA ★
1201789	Replacement Remote	\$53⁹⁹ EA ★
1167443	Replacement Power Cord/Adaptor	\$25⁹⁹ EA ★

BUILT IN CONTROL PANEL



WIRELESS REMOTE

INDOOR/OUTDOOR TABLETOP SCOREBOARD

Same as our popular SK2229R tabletop scoreboard with the following added features:

- Dimensions: 16"H x 24"W x 10"D - 24 lbs.
- Dual LED setting for indoor and outdoor brightness
- AC/DC, with built-in rechargeable battery (up to 6 hour battery life depending on brightness setting)
- Portable use only (do not store outside or use during inclement weather)
- Assembled stand measures 43"H x 28"W x 28"D

SK999 Tabletop Scoreboard **\$599⁹⁹** EA ★

OPTIONS		
1293784	Wheeled Stand	\$99⁹⁹ EA ★
1240597	Extra Loud Horn	\$63⁹⁹ EA ★
1142266	Carry Bag	\$74⁹⁹ EA ★
1201789	Replacement Remote	\$53⁹⁹ EA ★
1167443	Replacement Power Cord/Adaptor	\$25⁹⁹ EA ★
1171570	Replacement Battery	\$39⁹⁹ EA ★

2. WIRELESS SHOTCLOCKS & CONTROLLER

Module included for use with the SK2229R or SK999 scoreboards.

- Dimensions: 20"H x 15"W x 7"D - 12 lbs. ea
- 8" LED shot clock digits (300' viewing distance) 4.7" game clock digits
- Power supplied by built-in rechargeable batteries or 110v AC power cord
- Built in horns
- Assembled stand measures 48"H x 16"W x 26"D
- Optional stand not included

1171525 **\$819⁹⁹** SET ★

OPTIONS		
1171556	Optional Stand	\$99⁹⁹ EA ★
1167443	Replacement Power Cord/Adaptor	\$25⁹⁹ EA ★
1171570	Replacement Battery	\$39⁹⁹ EA ★

Bid #ESCNJ 17/18-31

Educational Services Commission of New Jersey

Athletic Equipment & Supplies

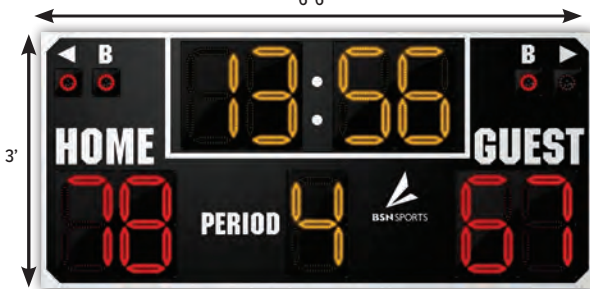

ULTIMATE SCOREBOARD

- 12" and 8" super-bright, 100,000 hour rated LED numerals (500' viewing distance)
- Scores 0-99 and clock will count down from 99:59
- Galvanized steel cabinet with powder-coated finish
- Includes horn, bonus and possession indicators
- Wireless remote standard
- Weight: 100 lbs.

5 Year Limited Warranty

MSBULTB	Black	\$2,899 ⁹⁹	EA ★	
MSBULTC	Specify Color	\$2,899 ⁹⁹	EA ★	
MSBNET4	Protective Net (7' x 3.5')	\$419 ⁹⁹	EA ★	

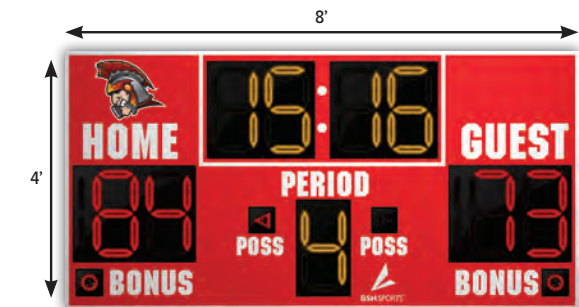

INDOOR SCOREBOARD

- 15" super-bright, 100,000 hour rated LED numerals (750' viewing distance)
- Scores 0-199 and clock will also count down from 99:59
- 1/10th second timing feature during final minute
- Galvanized steel cabinet with powder-coated finish
- Includes horn and 150 feet of control cable (if operated by cable)
- Weight: 180 lbs.

5 Year Limited Warranty

MSBBB3	Basic (8' x 3') - as shown	\$2,499 ⁹⁹	EA ★
MSBBB3DB	Double Bonus (8' x 3')	\$2,699 ⁹⁹	EA ★
MSBBB4	Basic (8' x 4')	\$3,199 ⁹⁹	EA ★
MSBBB4DB	Double Bonus (8' x 4')	\$3,299 ⁹⁹	EA ★

OPTIONS		
MSBREM4	Wireless Remote Control *	\$1,149 ⁹⁹ EA ★
1376992	Handi-Score	\$799 ⁹⁹ EA
MSBCBL	Control Cable	\$0.85 FT ★
MSBPPP4	Battery for Wireless Remote***	\$124 ⁹⁹ EA ★
MSBNET5	Protective Net (9' x 4.5')	\$489 ⁹⁹ EA ★
MSBSPN2	Sponsor Panel (21" X 8')	\$449 ⁹⁹ EA ★
MSBBB4L	Logo Above Home/Guest	\$249 ⁹⁹ EA
1366507	Receiver for 2nd Scoreboard**	\$279 ⁹⁹ EA



8' X 5' INDOOR SCOREBOARD

- 15" super-bright, 100,000 hour rated LED numerals (750' viewing distance)
- Scores 0-199 and clock will also count down from 99:59
- 1/10th second timing feature during final minute
- Interchangeable panels for volleyball and wrestling
- Galvanized steel cabinet with powder-coated finish
- Includes horn and 150' of control cable (if operated by cable)
- Weight: 260 lbs.

5 Year Limited Warranty

MSBBB1	Basic (As Shown)	\$3,499 ⁹⁹	EA ★	
MSBBB1DB	Double Bonus	\$3,699 ⁹⁹	EA ★	
MSBBB1TO	Timeouts Left	\$3,699 ⁹⁹	EA ★	
MSBBB1DT	Double Bonus/Timeouts Left	\$3,799 ⁹⁹	EA ★	

OPTIONS		
MSBREM4	Wireless Remote Control *	\$1,149 ⁹⁹ EA ★
MSBCASE2	Carry Case for Wireless Remote	\$169 ⁹⁹ EA ★
MSBCBL	Control Cable***	\$0.85 FT ★
MSBPPP4	Battery for Wireless Remote	\$124 ⁹⁹ EA ★
MSBNET7	Protective Net (9' x 8')	\$519 ⁹⁹ EA ★
MSBSPN2	Sponsor Panel (21" X 8')	\$449 ⁹⁹ EA ★
MSBBB4L	Artwork Left/Right of Fouls	\$249 ⁹⁹ EA
1366507	Receiver for 2nd Scoreboard**	\$279 ⁹⁹ EA

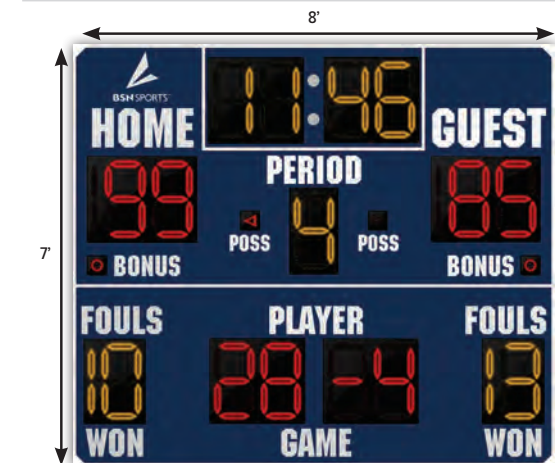

8' X 7' INDOOR SCOREBOARD

- 15" super-bright, 100,000 hour rated LED numerals (750' viewing distance)
- Scores 0-199 and clock will also count down from 99:59
- 1/10th second timing feature during final minute
- Interchangeable panels for volleyball and wrestling
- Galvanized steel cabinet with powder-coated finish
- Includes horn and 150' of control cable (if operated by cable)
- Weight: 260 lbs.

5 Year Limited Warranty

MCSBI86M	Basic (as shown)	\$4,799 ⁹⁹	EA ★	
MCSBI86MDB	Double Bonus	\$4,899 ⁹⁹	EA ★	
MCSBI86MTO	Timeouts Left	\$4,899 ⁹⁹	EA ★	
MCSBI86MDT	Dbl Bonus/Time Out	\$5,099 ⁹⁹	EA ★	

OPTIONS		
MSBREM4	Wireless Remote Control *	\$1,149 ⁹⁹ EA ★
MSBCBL	Control Cable	\$0.85 FT H
MSBPPP4	Battery for Wireless Remote ***	\$124 ⁹⁹ EA ★
MSBNET8	Protective Net (9' x 11')	\$729 ⁹⁹ EA ★
MSBSPN2	Sponsor Panel (21" X 8')	\$449 ⁹⁹ EA ★
1366507	Receiver for 2nd Scoreboard**	\$279 ⁹⁹ EA



SCOREBOARD COLOR OPTIONS

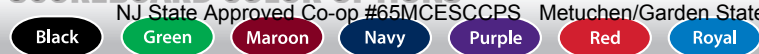

NJ State Approved Co-op #65MCECCPS Metuchen/Garden State Appar. Bid Term: 5/9/18 to 5/8/20 Extended to 5/8/21

* Must be factory installed

*** Battery not included with wireless remote

NEW! Bid #ESCNJ 17/18-31

Educational Services Commission of New Jersey Athletic Equipment & Supplies

BASKETBALL SCOREBOARD W/VIDEO BOARD

VIDEO DISPLAY FEATURES:

- 6mm Pixel Pitch full color RGB video display for high resolution images
- Maximum Fan Experience with included presentation software and in game flash messages
- Boost vendor and sponsorship revenue
- Optional sponsor panels around the video display
- Includes Video Operating System - Laptop Computer preloaded with presentation software, Video Processor enabling live video, 1920 x 1080 Camcorder, Fluid head camera tripod for smooth panning and live video
- Connect to facility's existing sound system with audio interface box
- Leave no fan out with incredible 120 degree viewing angles
- Optional sponsor panels around the video display, please call for pricing
- Software includes: Player Profile Templates – ideal for showing starting lineups & Pre-designed Game Templates
- Allow 8 - 10 weeks for delivery
- Installation charges NOT included

SCOREBOARD FEATURES:

- 15" super-bright, 100,000 hour rated LED numerals in galvanized steel cabinet
- Double bonus and time outs left
- Includes horn, and 150' of control cable (if operated by cable)

5 Year Limited Warranty

MSBBB10DT	14" x 5" Scoreboard	\$6,699 ⁹⁹ EA ★
1390145	10" x 6" (approx.) Video Display	\$29,999 ⁹⁹ EA

OPTIONS		
MSBREM4	Wireless Remote Control *	\$1,149 ⁹⁹ EA ★
MSBPP4	Battery for Wireless Remote ***	\$124 ⁹⁹ EA ★
MSBCASE2	Carry Case for Wireless Remote	\$169 ⁹⁹ EA ★
MSBSPN114	Top Sponsor Panel - 14" x 21"	\$799 ⁹⁹ EA ★
1390148	Side Sponsor Panels - 6" x 21" (PR)	\$849 ⁹⁹ PR



SHOT CLOCK/SCOREBOARD



NEW!

18' X 8' BASKETBALL/VOLLEYBALL SCOREBOARD W/PLAYER PANELS

- 15" super-bright, 100,000 hour rated LED numerals (750' viewing distance)
- 9" super-bright, 100,000 hour in player panels for volleyball and basketball
- Scores 0-199 and clock will also count down from 99:59
- 1/10th second timing feature during final minute
- Interchangeable panels for volleyball and wrestling
- Galvanized steel cabinet with powder-coated finish
- Built-In sponsor panel at bottom of scoreboard
- Includes horn and 150' of control cable (if operated by cable)
- Weight - 900 lbs.

5 Year Limited Warranty

MSBB9PPF6	As Shown	\$12,599 ⁹⁹ EA ★
-----------	----------	-----------------------------



OPTIONS		
MSBREM13	Wireless Remote Control *	\$1,659 ⁹⁹ EA ★
MSBCBL	Control Cable	\$0.85 FT H
MSBCASE2	Carry Case for Wireless Remote	\$169 ⁹⁹ EA ★
MSBPP4	Battery for Wireless Remote ***	\$124 ⁹⁹ EA ★
MSPSPN18	Sponsor Panel (18" x 21")	\$1,069 ⁹⁹ EA ★
1366507	Receiver for 2nd Scoreboard**	\$279 ⁹⁹ EA
MSBPSC	Shot Clock - PR	\$2,199 ⁹⁹ SET ★

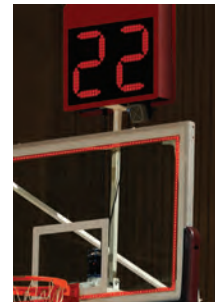

SCOREBOARD COLOR OPTIONS



* Must be factory installed

** Two scoreboards only work together on one controller with wireless option

Appare Bid Term: 5/9/18 to 5/8/20: Extended to 5/8/21

SCOREBOARDS

Bid #ESCNJ 17/18-31

Educational Services Commission of New Jersey

Athletic Equipment & Supplies

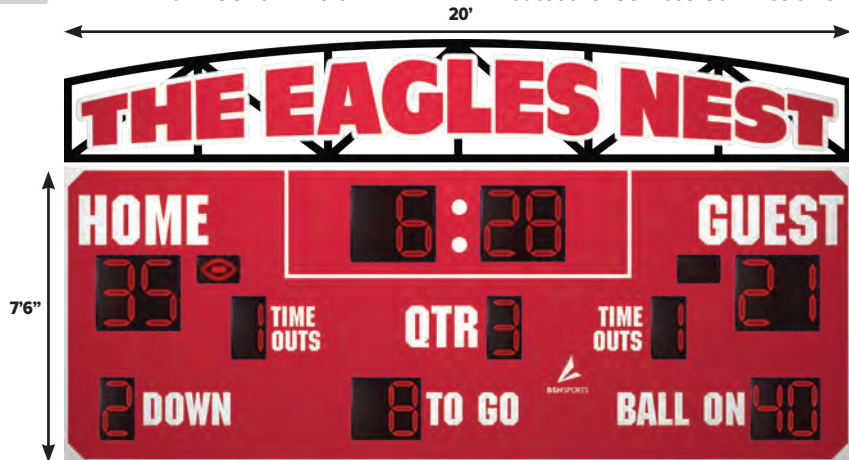

20' X 7' 6" FOOTBALL SCOREBOARD

- 20" and 15" super-bright, 100,000 hour rated LED numerals with digit protective shields (1000' viewing distance)
- Wireless remote now comes with external High Gain Antenna for improved communication from press box to scoreboard
- Galvanized steel cabinet with powder-coated finish
- Includes operator keyboard with AC wall transformer (customer must order cable length separately), junction box cover, and mounting rails
- Complete operation, installation and service manual
- Track time option is available
- Time Outs Left Feature comes standard
- Weight: 1250 lbs.

5 Year Limited Warranty

MSBFB14T0	Basic	\$9,199 ⁹⁹ EA ★	
MSBFB9T0L	With Track Timer	\$9,999 ⁹⁹ EA ★	

OPTIONS

MSBREM4HG	Wireless Remote w/High Gain Antenna*	\$1,399 ⁹⁹ EA ★
MSBREM4	Wireless Remote Control *	\$1,149 ⁹⁹ EA ★
MSBCBL	Control Cable	\$0.85 FT ★
MSBPP4	Battery for Wireless Remote***	\$124 ⁹⁹ EA ★
MSBHORN	Loud Outdoor Horn	\$599 ⁹⁹ EA ★
MSBSPN5	Sponsor Panel (20' X 31")	\$1,199 ⁹⁹ EA ★
MSBFB14CKB	Baseball Conversion Kit	\$469 ⁹⁹ EA ★
MSBFB14CKS	Soccer Conversion Kit	\$469 ⁹⁹ EA ★



NEW!

14' X 6' FOOTBALL SCOREBOARD

- 15" super-bright, 100,000 hour rated LED numerals with digit protective shields (750' viewing distance)
- Optional conversion kits for baseball and soccer (see options)
- Galvanized steel cabinet with powder-coated finish

- Includes operator keyboard with AC wall transformer (customer must order cable length separately), junction box cover and mounting rails
- Complete operation, installation and service manual
- Weight - 500 lbs.

5 Year Limited Warranty

MSBFB15	As Shown	\$6,399 ⁹⁹ EA ★
---------	----------	----------------------------

OPTIONS

MSBREM4	Wireless Remote Control *	\$1,149 ⁹⁹ EA ★
MSBREM4HG	Wireless Remote w/High Gain Antenna*	\$1,399 ⁹⁹ EA ★
1376995	Handi-Score	\$799 ⁹⁹ EA
MSBCBL	Control Cable	\$0.85 FT ★
MSBPP4	Battery for Wireless Remote***	\$124 ⁹⁹ EA ★
MSBHORN	Loud Outdoor Horn	\$599 ⁹⁹ EA ★
MSBSPN014	Sponsor Panel (14' x 21")	\$799 ⁹⁹ EA ★
MSBFB15CKB	Baseball Conversion Kit	\$439 ⁹⁹ EA ★
MSBFB15CKS	Soccer Conversion Kit	\$439 ⁹⁹ EA ★



8' X 5' FOOTBALL SCOREBOARD

- 15" super-bright, 100,000 hour rated LED numerals with digit protective shields (750' viewing distance)
- Optional conversion kits for baseball and soccer (see options)
- Galvanized steel cabinet with powder-coated finish
- Includes operator keyboard with AC wall transformer (customer must order cable length separately), junction box cover and mounting rails
- Complete operation, installation and service manual
- Weight: 275 lbs.

5 Year Limited Warranty

MSBFB2	As Shown	\$5,199 ⁹⁹ EA ★	
--------	----------	----------------------------	--

OPTIONS

MSBREM4	Wireless Remote Control *	\$1,149 ⁹⁹ EA ★
1376995	Handi-Score	\$799 ⁹⁹ EA ★
MSBCBL	Control Cable	\$0.85 FT ★
MSBPP4	Battery for Wireless Remote***	\$124 ⁹⁹ EA ★
MSBHORN	Loud Outdoor Horn	\$599 ⁹⁹ EA ★
MSBSPN2	Sponsor Panel (21" X 8")	\$449 ⁹⁹ EA ★
MSBCKBS	Baseball Conversion Kit	\$299 ⁹⁹ EA ★
MSBCKSC	Soccer Conversion Kit	\$299 ⁹⁹ EA ★



SCOREBOARD COLOR OPTIONS



* Must be factory installed

** Two scoreboards only work together on one controller with wireless option

*** 12V 500mAh NiMH Rechargeable Battery (sold separately)

HandiScore Bid Term: 5/9/18 - 5/8/20: Extended to 5/8/21



FOOTBALL DELAY-OF-GAME CLOCK

- 26" super bright 100,000-hour rated LED displays (1000' viewing distance)
- Available as an independent system or for attachment to an existing MacGregor football scoreboard
- Optional wheel stand available
- Galvanized steel cabinet with powder-coated finish
- Weight - 85 lbs. (each clock)
- (Wireless remote required for Hand Held Controller option)

5 Year Limited Warranty

MSBFB6	Independent System	\$4,299 ⁹⁹	PR ★	S&H
MSBFB6S	Independent System w/Stands	\$4,799 ⁹⁹	PR ★	S&H
MSBFB7	Existing Scoreboard	\$3,699 ⁹⁹	PR ★	S&H
MSBFB7S	Existing Scoreboard w/ Stands	\$4,199 ⁹⁹	EA ★	S&H

OPTIONS

MSBCBL	Control Cable	\$0.85	FT ★
MSBPP4	Battery for Wireless Remote	\$124 ⁹⁹	EA ★
MSBREM8	Wireless Remote - Independent System	\$1,749 ⁹⁹	EA
MSBREM9	Wireless Remote - Existing System	\$1,199 ⁹⁹	EA
1376996	Hand Held Controller	\$659 ⁹⁹	EA
1388078	Portable Power Pack - Pair	\$1,849 ⁹⁹	PR ★



FOOTBALL SEGMENT TIMER

- 13" super-bright, 100,000 hour rated LED numerals (300' viewing distance)
- Interchangeable colon and white divider line allows user to change the configuration of the timer so the period can go to 9 or 99
- Count down from 9:59 or 99:59
- Built-in horn
- Galvanized steel cabinet with powder-coated finish
- Not water proof - do not use in inclement weather or leave outdoors
- Made to order - no returns allowed except for issues related to a manufacturers defect
- Includes controller with 10' control cable and 25' control cable extension
- Weight: 45 lbs.

2 Year Limited Warranty

MSBFB5	Segment Timer	\$2,099 ⁹⁹	EA ★
--------	---------------	-----------------------	------

OPTIONS

MSBFB5ST	Portable Stand	\$209 ⁹⁹	EA ★
MSBREM3	Wireless Remote Control*	\$899 ⁹⁹	EA ★
MSBDPS2	Dual Power System*	\$259 ⁹⁹	EA ★
MSBBAT3	External Battery	\$199 ⁹⁹	EA ★



MADE TO ORDER - NO RETURNS.

SCOREBOARD COLOR OPTIONS

- Black
 - Green
 - Maroon
 - Navy
 - Purple
 - Red
 - Royal
- * Must be factory installed

SEGMENT TIMER W/WIRELESS REMOTE

- 8" and 13" super-bright, LED numerals (300' viewing distance)
- Program your practice schedule and workout drills
- All steel cabinet with built in handle, weather protector, fence attachment and storage pouch for remote programmer
- AC or DC with built-in, 8 hour rechargeable battery
- 140 decibel horn sounds after each segment, 3 short beeps after each rest period
- Program up to 99 segments from 1 second to 99 minutes. The last minute always counts down in seconds
- Wireless remote remembers last entry and has a range of 65 feet
- Not water proof - do not leave outside when not in use
- Weight: 26 lbs.

1239645	Segment Timer	\$1,499 ⁹⁹	EA ★
1239652	Replacement Wireless Remote	\$79 ⁹⁹	EA ★
1171570	Replacement Battery	\$35 ⁹⁹	EA ★



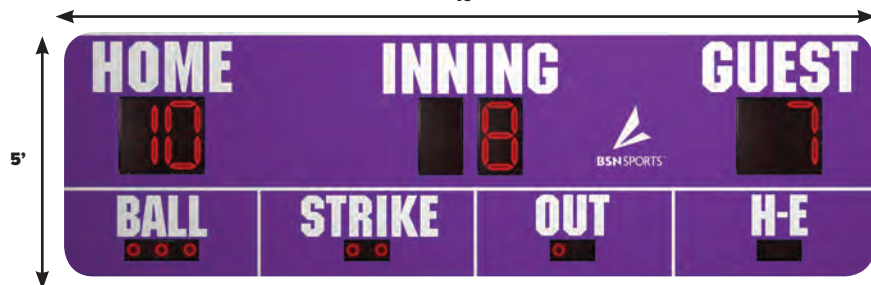

16' X 5' BASEBALL SCOREBOARD

- 15" super-bright, 100,000 hour rated LED numerals with digit protective shields (750' viewing distance)
 - Galvanized steel cabinet with powder-coated finish
 - Scores & innings up to 99
 - Weight: 650 lbs.
- 5 Year Limited Warranty**

MSBBS1

As Shown

\$4,299⁹⁹ EA ★



OPTIONS		
MSBREM2	Wireless Remote Control*	\$899⁹⁹ EA ★
MSBCBL	Control Cable	\$0.85 FT ★
MSBPP4	Battery for Wireless Remote	\$124⁹⁹ EA ★

1376993	Handi-Score	\$799⁹⁹ EA
MSBBSPN4	Sponsor Panel (21" x 16")	\$829⁹⁹ EA ★
MSBBS1L	Custom Logo Left/Right of Inning	\$629⁹⁹ EA ★

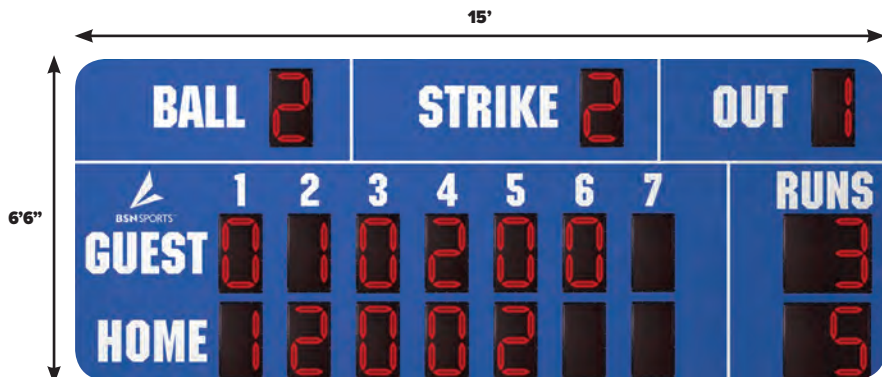

15' X 6'6" BASEBALL SCOREBOARD

- 15" super-bright, 100,000 hour rated LED numerals with digit protective shields (750' viewing distance)
 - Galvanized steel cabinet with powder-coated finish
 - Displays home & guest scores by inning up to 7 innings
 - Operates by wireless remote or direct cable (see OPTIONS)
 - Weight 650 lbs.
- 5 Year Limited Warranty**

MSBBS11

As Shown

\$7,999⁹⁹ EA ★



OPTIONS		
MSBREM4	Wireless Remote Control *	\$1,149⁹⁹ EA ★
MSBCBL	Control Cable	\$0.85 FT ★
MSBPP4	Battery for Wireless Remote***	\$124⁹⁹ EA ★
MSBSPN6	Sponsor Panel (15' X 21")	\$799⁹⁹ EA ★



14' X 5' BASEBALL SCOREBOARD **NEW!**

- 15" super-bright, 100,000 hour rated LED numerals with digit protective shields (750' viewing distance)
 - Galvanized steel cabinet with powder-coated finish
 - Scores & innings up to 99
 - Clock counts down from 99 minutes, final minute in seconds
 - Weight - 450 lbs.
- 5 Year Limited Warranty**

MSBBS18

As Shown

\$5,199⁹⁹ EA ★

OPTIONS		
MSBREM4	Wireless Remote Control *	\$1,149⁹⁹ EA ★
MSBCBL	Control Cable	\$0.85 FT ★
MSBPP4	Battery for Wireless Remote***	\$124⁹⁹ EA ★
MSBSPN014	Sponsor Panel (14' x 21")	\$799⁹⁹ EA ★

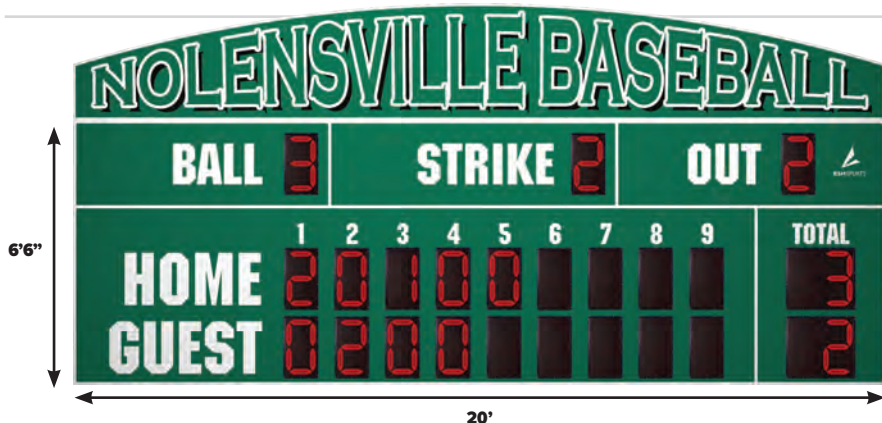

20' X 6'6" BASEBALL SCOREBOARD **NEW!**

- 15" super-bright, 100,000 hour rated LED numerals with digit protective shields (750' viewing distance)
 - Galvanized steel cabinet with powder-coated finish
 - Displays home and guest scores by inning up to 9 innings
 - Scoreboard Weight - 600 lbs.
 - Arched Panel Weight - 250 lbs.
- 5 Year Limited Warranty**

MSBBS19

Scoreboard Only

\$8,799⁹⁹ EA ★

OPTIONS		
MSBCAPN20	Arched Top Panel	\$1,699⁹⁹ EA ★
MSBREM4	Wireless Remote Control *	\$1,149⁹⁹ EA ★
MSBCBL	Control Cable	\$0.85 FT ★
MSBPP4	Battery for Wireless Remote ***	\$124⁹⁹ EA ★
MSBSPN20	Sponsor Panel (20' X 21")	\$1,199⁹⁹ EA ★



8' X 4' BASEBALL SCOREBOARD

- 15" red, super-bright, 100,000 hour rated LED numerals with digit protective shields (750' viewing distance)
- Galvanized steel cabinet with powder-coated finish
- Scores to 99, innings to 9
- Operated by wireless remote or direct cable
- Weight - 275 lbs.

5 Year Limited Warranty

MSBBS5 Scoreboard Only \$2,999⁹⁹ EA ★ 

OPTIONS

MSBREM2	Wireless Remote (Board Only)*	\$899 ⁹⁹ EA ★
1376993	Handi-Score	\$799 ⁹⁹ EA
MSBCBL	Control Cable	\$0.85 FT ★
MSBSPN1	Sponsor Panel (21" X 8')	\$449 ⁹⁹ EA ★

BASEBALL PITCH COUNTER

- 15" super-bright, 100,000 hour rated LED numerals (750' viewing distance)
- HOME and GUEST pitch count to 99 for two-digit model and 199 for three-digit model
- Add on model works with BSN Baseball/Softball scoreboards
- Stand-alone models includes cable controller
- Galvanized steel cabinet with powder-coated finish

5 Year Limited Warranty

MSBPCB	2-Digit Add-On Option	\$1,899 ⁹⁹ EA ★
MSBPCA	2-Digit Stand Alone	\$2,199 ⁹⁹ EA ★
MSBPC3	3-Digit Add-On Option	\$2,199 ⁹⁹ EA ★
MSBPC3A	3-Digit Stand Alone	\$2,549 ⁹⁹ EA ★



NEW!

9' X 6' BASEBALL SCOREBOARD

- 15" super-bright, 100,000 hour rated LED numerals with digit protective shields (750' viewing distance)
- Galvanized steel cabinet with powder-coated finish
- Scores to 99, innings to 9
- Clock counts down from 99 minutes, final minute in seconds
- Clock can be used as a 2 digit pitch count
- Weight - 500 lbs.

5 Year Limited Warranty

MSBBS21 As Shown \$4,199⁹⁹ EA ★

OPTIONS

MSBREM4	Wireless Remote Control*	\$1,149 ⁹⁹ EA ★
MSBCBL	Control Cable	\$0.85 FT ★
MSBPP4	Battery for Wireless Remote***	\$124 ⁹⁹ EA ★
MSBSPN9	Sponsor Panel (9' x 21")	\$539 ⁹⁹ EA ★



NEW!

14' X 7'6" BASEBALL SCOREBOARD

- 15" super-bright, 100,000 hour rated LED numerals with digit protective shields (750' viewing distance)
- Galvanized steel cabinet with powder-coated finish
- Scores & innings up to 99
- Integrated 2 digit pitch count
- Weight - 600 lbs.

5 Year Limited Warranty

MSBBS20 As Shown \$5,599⁹⁹ EA ★



OPTIONS

MSBREM4	Wireless Remote Control*	\$1,149 ⁹⁹ EA ★
MSBCBL	Control Cable	\$0.85 FT ★
MSBPP4	Battery for Wireless Remote***	\$124 ⁹⁹ EA ★
MSBSPN014	Sponsor Panel (14' x 21")	\$799 ⁹⁹ EA ★



SCOREBOARD COLOR OPTIONS



- * Must be factory installed
- ** Two scoreboards only work together on one controller with wireless option
- *** Battery not included with wireless remote



8' X 4' SOCCER OUTDOOR SCOREBOARD

- 15" red, super-bright, 100,000 hour rated LED numerals with digit protective shields (750' viewing distance)
 - Galvanized steel cabinet with powder-coated finish
 - Scores to 99, periods to 9
 - Clock counts down from 99:59 with 1/10th seconds during final minute
 - Operated by wireless remote or direct cable (see OPTIONS)
 - Weight - 180 lbs.
- 5 Year Limited Warranty**

MSBMT2	As Shown	\$2,999 ⁹⁹ EA ★	S&H
OPTIONS			
MSBREM4	Wireless Remote Control *	\$1,149 ⁹⁹ EA ★	
1376994	Handi-Score	\$799 ⁹⁹ EA ★	
MSBCBL	Control Cable	\$0.85 FT ★	
MSBPP4	Battery for Wireless Remote***	\$124 ⁹⁹ EA ★	
MSBHORN	Loud Outdoor Horn	\$599 ⁹⁹ EA ★	
MSBSPN1	Sponsor Panel (21" X 8')	\$449 ⁹⁹ EA ★	

SEE COLOR OPTIONS ON PAGE 367

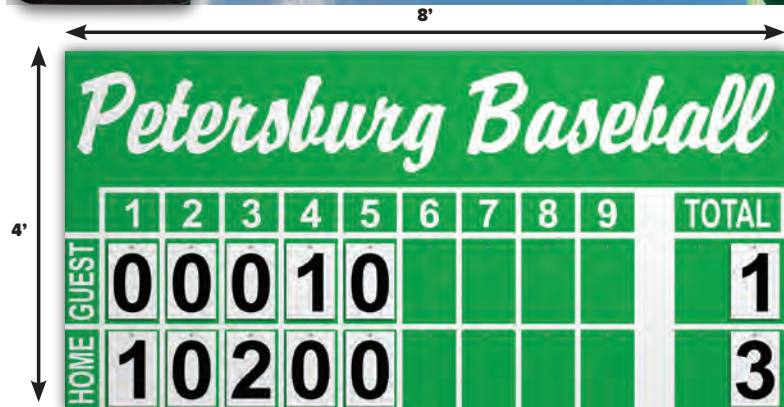

8' X 4' HANGING NUMBERS BASEBALL SCOREBOARD

- 9" plastic numbers (300' viewing distance)
- Galvanized steel cabinet with powder-coated finish
- Scores to 99 for each inning, 99 for total
- Comes complete with (1) set of hanging numbers and hooks
- Designed to mount on two 4" X 4" posts (not included)
- Weight: 100 lbs.

MSBBS8	Scoreboard Without Lettering	\$849 ⁹⁹ EA ★	S&H
MSBLTR3	Sponsor Panel Lettering (1 color)	\$209 ⁹⁹ EA ★	
MCSBNU84	Extra Set Hanging Numbers	\$219 ⁹⁹ SET ★	

MULTI-SPORT MANUAL OUTDOOR SCOREBOARD

- 9" Yellow fluorescent numbers (300' viewing distance)
- Scores to 99, Period / Inning to 9
- "Moveable window" numbers slide in and out of view
- Economical and easy to use, requires no electricity
- Leg assembly, fence mount hardware and sponsor panel lettering sold separately
- Weight: 20 lbs.

MSBBS4	Scoreboard Only	\$529 ⁹⁹ EA ★
--------	-----------------	--------------------------

OPTIONS		
MSBBS4LA	Leg Assembly	\$189 ⁹⁹ EA ★
MSBBS4FW	Fence/Wall Mount	\$29 ⁹⁹ EA ★
MSBBS4LT	Sponsor Panel Lettering (1 Color)	\$199 ⁹⁹ EA ★

8' X 3' BASEBALL SCOREBOARD

- 15" super-bright, 100,000 hour rated LED numerals with digit protective shields (750' viewing distance)
- Galvanized steel cabinet with powder-coated finish
- Built in space for team logo or sponsor
- Scores to 99, innings to 9
- Weight: 250 lbs.

5 Year Limited Warranty

MSBBS13	As Shown	\$3,249 ⁹⁹ EA ★
---------	----------	----------------------------

OPTIONS		
MSBREM2	Wireless Remote (Board Only)*	\$899 ⁹⁹ EA ★
1376993	Handi-Score	\$799 ⁹⁹ EA
MSBCBL	Control Cable	\$0.85 FT ★
MSBSPN1	Sponsor Panel (21" X 8')	\$449 ⁹⁹ EA ★

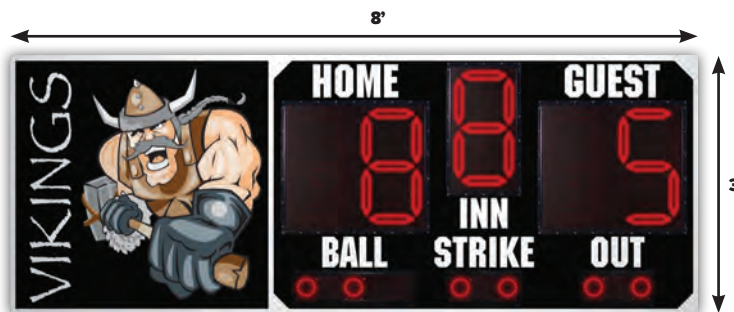

MSBBS13	As Shown	\$3,249 ⁹⁹ EA ★	S&H
---------	----------	----------------------------	-----

NJ State Approved Co-op #65MCESCPS - Metuchen/Garden State AppareBid Term: 5/9/18 - 5/8/20: Extended to 5/8/21

*MUST BE FACTORY INSTALLED

8' X 5' LACROSSE & SOCCER SCOREBOARD

- 15" red, super-bright 100,000 rated LED numerals with LED digit protective shields (750' viewing distance)
- Scores up to 99, periods up to 9
- Operated by wireless remote or direct cable but customer must order cable length separately (see OPTIONS)
- Includes standard keyboard controller with Lacrosse keypad insert
- Clock counts down from 99 minutes max, last minute in seconds
- Galvanized steel cabinet with powder coat finish

5 Year Limited Warranty

MCSBSC86 Scoreboard Only \$3,899⁹⁹ EA ★

OPTIONS			
MSBREM4	Wireless Remote Control *	\$1,149 ⁹⁹	EA ★
1376994	Handi-Score	\$799 ⁹⁹	EA ★
MSBCBL	Control Cable	\$0.85	FT ★
MSBHORN	Loud Outdoor Horn	\$599 ⁹⁹	EA ★
MSBPP4	Battery for Wireless Remote***	\$124 ⁹⁹	EA ★
MSBSPN1	Sponsor Panel (21" X 8')	\$449 ⁹⁹	EA ★



LACROSSE SHOT CLOCK

- 15" super bright 100,000-hour rated LED displays (up to 750' viewing distance)
- Galvanized steel cabinet with powder-coated finish
- Built in horn with two preset times
- Includes two shot clocks, wireless LCD controller and wireless hand held ref switch
- AC powered with optional power pack available
- Portable wheel stands available as optional purchase
- Weight - 40 lbs. (each clock)
- Available Colors: Black, Green, Maroon, Navy, Purple, Red, Royal

5 Year Limited Warranty

1388068	Clocks, Controller & Ref Switch	\$4,699 ⁹⁹	PR ★	
1388073	Optional Stands - Pair	\$599 ⁹⁹	PR ★	
1388078	Optional Port Power Pack - Pair	\$1,849 ⁹⁹	PR ★	



PORTABLE MULTI-SPORT SCOREBOARD

- 9" and 6" super-bright, 100,000 hour rated LED numerals (750' viewing distance)
- Galvanized steel cabinet with powder-coated finish
- Ships standard as basketball board but easily converts to other sports using magnetic conversion kits (included)
- Scores baseball, softball, football, soccer, field hockey, lacrosse, volleyball, basketball, wrestling & track
- 1/10th and 1/100th second timing standard
- Comes with controller, 25' of control cable, built in rechargeable 12v battery and charger
- Does not come with sponsor panel, must be purchased with initial order
- Not water-proof, do not use in inclement weather or leave outdoors
- 12 hour charge will provide 6 hours of run time
- Weight: 95 lbs.

5 Year Limited Warranty

MSBMT6 \$3,399⁹⁹ EA ★

OPTIONS			
MSBREM3	Wireless Remote Control*	\$899 ⁹⁹	EA ★
MSBBAT3	External Battery	\$199 ⁹⁹	EA ★
MSBLTR7	Sponsor Panel and Lettering	\$349 ⁹⁹	EA ★

MADE TO ORDER - NO RETURNS



SCOREBOARD COLOR OPTIONS



- * Must be factory installed
- ** Two scoreboards only work together on one controller with wireless option
- *** Battery not included with wireless remote



PORTABLE MANUAL SCOREKEEPER

- 6" score digits
- 2.5" Period/Games digit up to 5
- Scores game up to 99 for each side
- No assembly required
- Lays flat for storage

1196177 11"H x 23"W \$49⁹⁹ EA ★



MANUAL SCOREKEEPER WITH ADJUSTABLE STAND

- 7" numbers printed on vinyl
- Scores up to 99 for each team
- Two erasable team panels
- PVC stand measures 38"H with a 15" x 15" base
- Converts from floor model to 12"H table top unit

1162448 \$51⁹⁹ EA ★



MANUAL TABLETOP DOUBLE SIDED SCOREBOARD

- 6" numbers for scoring
- 2.5" numbers to score games (0-5 for each side)
- Scores up to 30 for each team
- Double-sided, see the score from front and back
- Folds up for easy transport and storage

MSMLTSCR 7"H x 15"W \$58⁹⁹ EA ★



BUDGET POSSESSION INDICATOR

- Rigid plastic triangular design with arrow
- Simply turn to indicate possession
- Weight: 1 lb.

1248395 \$22⁹⁹ EA ★



LED BASKETBALL POSSESSION INDICATOR

- Bright, 10,000 hour LED lights
- Toggle switch operation
- Includes 15' cord for AC operation
- Built in rechargeable battery with 4 - 6 hour battery life
- Weight: 5 lbs.

1155620 \$15⁹⁹ EA ★

NEW!

Robic

OSLO 1000W DUAL STOP WATCH W/COUNT DOWN TIMER

- Single Event-Lap or Split Timing to 10 hours
- 1/100 second precision Countdown Timer
- Track 2 activities Using the stopwatch and Countdown simultaneously
- Water Resistant—Soft Rubber grips offer Comfort
- Prism pack includes one each Blue, Green, Orange, Purple, Red and Yellow



1399652	Black Only	\$21.99 EA
1399651	Prism Pack of 6	\$119.99 EA



MacGregor

COUNT UP/DOWN CLOCK

- 4" LED numbers
- Timer counts up or down to 99:59
- 120 a/c power with 8 hour rechargeable battery
- Perfect device designed for any timed activities in your P.E. or Athletic program
- Built in control on top of timer with horn



1126631	6" H x 13" W x 4" D	\$279.99 EA ★
1139730	Replacement Battery	\$39.99 EA ★



Robic
BIG GAME TIMER

- Track two events at the same time
- Shows time remaining as a value and percentage of total
- Easy to operate rotary switch sets countdown time
- Local time of day and calendar
- AAA battery included

1369566	M803	\$37.99 EA
----------------	------	------------



Robic
LED TIMERS

- Flashing LED indicators confirm countdown status - active (green) or stopped (red)
- Use for timing any sport or recreational activity
- Count up or down functions
- Three alarm options - silent, regular or extra loud
- Single up to 99:59, Twin up to 99:59:59
- (2) AAA alkaline batteries included

1271355	M603 - 3 Memory Timer	\$20.99 EA
1369565	M703 - Twin Timer	\$24.99 EA



MacGregor

HANDHELD GAME TIMER

- Counts down from 99 minutes
- Features 1/100th second LED display, unlimited start-stop, audible end signal
- Includes clip with magnetic attachment
- (1) AAA battery included

MSSTP750	\$19.99 EA ★
-----------------	--------------



Robic
COUNTDOWN TIMER

- Countdown in seconds (up to 99 min. & 59 sec.)
- Can be used silently or with audible beep
- Onetouch reset to preset time
- Start & restart for time-outs
- Lock Function protects current setting
- Break-away Safety Lanyard
- Extralarge display

MSSTP502	SC-502T	\$24.99 EA
-----------------	---------	------------



NEW!

Robic
DUAL INTERVAL TRAINING TIMER

- Perfect for all types of Interval Training
- Provides two separate countdown timers which can be set to repeat the sequence and count the number of intervals completed
- Can be repeated up to 999 times
- Counts and displays number of reps
- Operates Silently or with Audible Beep

1399654	SC-513	\$19.99 EA
----------------	--------	------------



Robic
COUNT-UP & COUNTDOWN TIMER

- Track two events at the same time
- Count up/down from zero
- Select time in seconds or minutes
- Automatically resets to preset time
- Stop & restart for time-outs

1369564	SC-522	\$19.99 EA
----------------	--------	------------

BRACES



THE ONE ANKLE BRACE

- Comfortable in cleats or shoes during competition
- Very light and low profile
- Seamless construction under the foot
- Features anti slip criss-crossing side straps, side pulling stirrups, and cushioned tongue
- Fits either foot
- Color - black only



1375722 Specify Size \$39.99 EA

FITS STANDARD SIZE SHOE

	MD	LG	XL	2XL	3XL
U.S. MEN	9-11	11-13	13-15	15-17	17-19
U.S. WOMEN	10-12	12-14	14-16	16-18	18-20



PRO LEVEL HINGED KNEE BRACE

- Extra large triaxial hinge properly tracks the knee joint producing near normal motion
- Removable patellar buttress can be cut to desired shape for proper tracking
- Extra long for maximum stability
- Lockout option for complete immobilization or limited range of motion (tool included)
- Fits either knee



1362673 Specify Size \$68.99 EA

	7 in below center of knee	7 in below center of knee
SM	18-19 in (46-48 cm)	13-14 in (31-34 cm)
MD	19-20 in (48-50 cm)	14-15 in (35-38 cm)
LG	21-22 in (53-55 cm)	15-16 in (38-40 cm)
XL	23-24 in (58-60 cm)	16-17 in (40-43 cm)
2XL	25-26 in (63-66 cm)	17-18 in (43-45 cm)

If measurements indicate different sizes, choose the larger size.



T2 ACTIVE ANKLE

- Durable quick fitting single strap system adjustable for both high and low top shoes
- Feather-light E.V.A. padding that hugs every contour of the ankle



1050929 Specify Size \$49.99 EA

	S	MD	LG
U.S. MEN	5-8	9-12	12-16



PRO LEVEL ATF2 ANKLE BRACE

- Next generation inner straps help protect against inversion sprains
- Single layer of comfortable fabric over the ankle bones
- Rigid plastic stays act like tendons to reinforce both sides
- Permanently bonded antimicrobial barrier
- Fits either foot



1362663 Black - Specify Size \$29.99 EA

1362658 White - Specify Size \$29.99 EA

	XS	SM	MD	LG	XL
U.S. MEN	6-7	7-9	9-11	11-13	13-15
U.S. WOMEN	7-8	8-10	10-12	12-14	14-16



HG80 HINGED KNEE BRACE

- Triaxial hinge properly tracks the knee joint producing near normal motion
- Tibial containment system with secondary shell and patella buttress
- Upper and lower trapping system
- Highly comfortable Mueller exclusive HydraCinn fabric
- Permanently bonded antimicrobial barrier
- Free carry bag included!
- Fits either knee



1362668 Specify Size \$59.99 EA

S	MD	LG	XL	2XL
12-114 in 30-35 cm	14-16 in 35-40 cm	16-18 in 40-45 cm	18-20 in 45-50 cm	20-22 in 50-55 cm

MEASURE THE CENTER OF THE KNEE



PORTABLE TREATMENT TABLE

- Lightweight aluminum frame
- 2 1/2" thick multi layered semi firm foam
- Push button height adjustment
- includes carry bag with shoulder sling

1394858 Specify Size \$89.99 EA



WOOD TREATMENT TABLE WITH SHELF

- Adjustable back rest
- Black upholstered top
- Weight - 400 lbs

1394859 30" x 78" x 30" \$969.99 EA





DOUBLE ANKLE

- Compression wrap for ankle
- Comes with two 11" refillable ICE20 ice bags
- Durable mesh carry bag included

1385287 Fits L or R \$49⁹⁹ EA



DOUBLE KNEE

- Compression wrap for knee
- Comes with two 11" refillable ICE20 ice bags
- Durable mesh carry bag included

1385290 Fits L or R \$79⁹⁹ EA



COMBO ARM

- Compression wrap for shoulder to elbow
- Comes with two 11" and one 9" refillable ICE20 icebags
- Durable mesh carry bag included

1385294 Fits L or R \$119⁹⁹ EA



BACK / HIP

- Use for upper, mid, lower back
- Also used for hip, glutes, abs, pelvis
- Comes with one refillable 11" ICE20 icebag
- Durable mesh carry bag included

1385293 Fits L or R \$59⁹⁹ EA



LARGE KNEE

- Compression wrap for adult knee
- Comes with one 11" refillable ICE20 icebag
- Durable mesh carry bag included

1385289 Fits L or R \$49⁹⁹ EA



SINGLE SHOULDER

- Pleated fabric design enables the ice bag to contour around the body
- Comes with one refillable 11" ICE20 icebag
- Durable mesh carry bag included

1385291 Fits L or R \$59⁹⁹ EA



TUF-SKIN® COLORLESS SPRAY

- Helps secure all tapes, underwrap and elastics to the skin in order to reduce friction and help prevent blisters and chafing
- Same formula as original Tuf-Skin® without the color; will not stain skin or clothes
- FAA regulations, can not ship via overnight air or 2nd day air.



1078226 10 oz. Can \$19⁹⁹ EA



REUSABLE HOT/COLD PACKS

- Soft gel refrigerates for cold therapy and microwaves for heat therapy
- A versatile, non-toxic pack ideal for applying cold therapy or heat therapy



1397418 4.75" x 6" \$29⁹⁹ PACK
1397419 6" x 9" \$39⁹⁹ PACK



INSTANT COLD PACK

- Convenient and ready whenever you need it
- No refrigeration needed - activates instantly
- Ideal for sports injuries or first aid



1397420 6" x 9" \$29⁹⁹ PACK

FLEX-I-WRAP

- 4" wide plastic film on a roller makes wrapping a one-handed task
- Replaces elastic wraps at a fraction of the cost
- Provides compression while clear film allows inspection of injury
- Patented, built-in hand brake on roller makes tearing easy



MDFLXWRP 6 rolls w/ handle \$72⁹⁹ SET
1082562 Handle only \$42⁹⁹ EA
1082555 6 rolls only \$66⁹⁹ EA

PRO-DOWN ICE BAGS

- 1500 each, 10" x 18" bags per roll
- 1 mil thick clear bags
- Dispenser sold separately



1089356 Dispenser only \$67⁹⁹ EA



Trainer Bags

- Multiple layers of external storage makes space better organized and more accessible so you can quickly find what you need, when you need it
- Semi-rigid shell is encased in a combination of our new super durable and stylish Tuf-Tek material and our 1680 ballistic nylon
- Rigid supports in the main walls make this the most protective soft-sided kit in the Cramer line. It also helps the kit keep its shape and keep it looking new
- Rounded corner design gives a large, more aerodynamic and sleek look

TUFF TEK SUPER

1375587	Empty	\$249⁹⁹ EA
1375586	Equipped	\$299⁹⁹ EA

TUFF TEK JUNIOR

1375585	Empty	\$159⁹⁹ EA
1375584	Equipped	\$229⁹⁹ EA



ATHLETIC TRAINER REFILL KIT

- Contains all the products you need to restock your trainer's kit in one easy purchase
- Contents: (1) 3" Elastic Wrap, (1) Tuf-Skin®, (1) PVP Pack, (1) Roll Athletic Tape, (1) Instant Cold Pack, (2) Latex Gloves, (1) Bulk Bandage Pack, (1) Skin Lube, (1) Sam® Finger Splint, (1) Iso-Quin®, (1) Sports Injury Handbook, (1) Zip-Cut®, (1) Atomic Balm®, (1) Cinder Suds®, (1) Tape Underwrap, (1) Pocket Mirror, (1) Sterile Eye Wash, (10) Antibiotic Creams
- Cannot be shipped by air

MDKITREF	\$99⁹⁹ EA
-----------------	-----------------------------

25 PERSON FIRST AID KIT

- 9" x 6 5/16" x 2 3/8" Plastic Case with Waterproof Gasket and Wall Mount/Handle
- Kit Contents: (2) 1/2" x 5yd Adhesive Tape, (1) Instant Cold Pack, (10) Antiseptic Towelettes, (2 pair) Disposable Gloves, (10) 1/32 oz. First Aid Cream, (100) 1" x 3" Adhesive Strips, (1) 5" x 9" Combine Pad, (6) 3" x 3" Gauze Pads, (2) Oval Eye Pads, (1) Triangular Bandage, (1) 2" x 4yd Conforming Bandage, Scissors and Forceps

1202106	OSHA Compliant	\$29⁹⁹ EA
----------------	----------------	-----------------------------



50 PERSON FIRST AID KIT

- 9" x 9" x 2 3/8" Plastic Case with Waterproof Gasket and Wall Mount/Handle
- Kit Contents: (2) 1/2" x 5yd Adhesive Tape, (2) Instant Cold Pack, (10) Antiseptic Towelettes, (2 pair) Disposable Gloves, (10) 1/32oz First Aid Cream, (8) Fingertip Bandages, (8) Knuckle Bandages, (2) Eye Wash Bottles, (100) 1" x 3" Adhesive Strips, (2) XL Adhesive Strips, (3) Insect Sting Relief, (1) 5" x 9" Combine Pad, (12) 2" x 2" Gauze Pads, (12) 3" x 3" Gauze Pads, (4) Oval Eye Pads, (2) Triangular Bandage, (2) 2" x 4yd. Conforming Bandage, (1) 4" x 2 yd. Conforming Bandage, (1) 3" Elastic Bandage, Scissors and Forceps

1202113	OSHA Compliant	\$57⁹⁹ EA
----------------	----------------	-----------------------------



SPORT MEDICAL KIT

- Soft padded cordura nylon bag with shoulder strap, heavy duty zipper, cold-pack holder with Velcro, waterproof bottom, and cell-phone compartment; 12" x 9" x 7", 7 lbs
- Kit includes: (1) 9" Reusable Ice Bag, (4) 6" x 8" Instant Cold Packs, (1) 6" x 30" Cold Pack Holder, (1) Blister Kit, (20) 1" x 3" Bandages, (6) 2" x 4.5" Large Bandages, (1) 3" x 5" Elastic Wrap, (1) Scissors, (10) Blood-Off Cloth Towelettes, (20) Latex-free Gloves, (1) 4 oz. Eye Wash, (2) Rolls 1.5"x15 yd. Athletic Tape, (1) Roll 2.75" x 30 yd. Pre-wrap, (20) Antimicrobial Skin Wipes, (1) Sport Wound Care Kit
- Note: The Refill Pack includes all of the items above with the exception of the Reusable Ice Bag, Cold Pack Holder and Scissors
- Both the Medical Kit and Refill Pack cannot be shipped by air

MDSPTMED	Equipped	\$249⁹⁹ EA
7911RFK	Refill Pack	\$149⁹⁹ KIT



COACH'S TEAM FIRST AID KIT

- Designed by athletic trainers to meet the first aid needs of competitive sports
- Contents: (2) Instant Cold Packs, (3) Knuckle Bandages, (5) Butterfly Bandages, (3) After Bite Sting Relief, (6) Tongue Depressors, (1) Tuf-Skin® Tape, (1) Tape Underwrap, (12) Antiseptic Towelettes, (10) 3" x 3" Gauze Pads, (3) Fingertip Bandages, (1) Scissors, (5) Antibiotic Cream, (1) Sports Injury Care Handbook, (1) Sam Finger Splint, (5) Acetaminophen, (10) 3/4" x 3" Bandages, (5) 2" x 4" Bandages, (6) Alcohol Prep Pads, (6) Latex Gloves, (1) 3" Elastic Wrap, (1) Skin Lube, (1) Triangle Bandage

1202096	\$49⁹⁹ EA
----------------	-----------------------------



PERSONAL FIRST AID KIT

- Plastic case with waterproof gasket
- Kit Contents: (10) 3/4" x 3" Adhesive Strips, (1) XL Adhesive Strip, (1), Fingertip Bandage, (1) Knuckle Bandage, (1) 2" Sterile Conforming Bandage, (2) 3" x 3" Gauze Pads, (2) Latex Gloves, (1) 1/2" x 5yd Adhesive Tape, (2) 1/32 oz. Triple Antibiotic, (2) 1/32 oz. First Aid Cream, (6) Antiseptic Towelette, (1) Instant Cold Pack, (1) Instant Sting Relief, (1) PAWS Antimicrobial Wipe

1202096	\$49⁹⁹ EA
----------------	-----------------------------

BSN SPORTS



BSN SPORTS PRE-WRAP

- Pre-taping foam underwrap that protects athlete's skin from chafing and irritation
- Each roll is 2.75" x 30 yards long
- 48 rolls per case

1378416

\$59.99 CASE



BSN SPORTS ATHLETIC TAPE

- 100% cotton backcloth, zinc oxide white trainer's tape
- High tensile strength with excellent tackiness
- 1 1/2" x 15 yard rolls

1405995

32 rolls per case

\$66.99 CASE



750 ATHLETIC TAPE

- Zinc Oxide tape offers maximum tensile strength and comfortability
- Latex free adhesive
- Computer calibrated unwind for consistency and performance roll to roll
- Roll: 1.5" x 15 yd
- 32 rolls per case

2190XXXX

Case of 32

\$72.99 PACK 32 ROLLS



M-WRAP

- Pre-taping foam underwrap
- Helps protect skin from tape chafing
- Can be used to keep hair out of face, hold pads and socks in place and as a protective wrap inside athletic footwear
- 48 rolls per case
- Specify color

Color Options: Black, Blue, Gold, Green, Lime, Maroon, Natural, Navy, Orange, Pink, Purple, Red.

1405975

2.75" x 30 yards per roll

\$59.99 CASE

- Red
- Blue
- Pink
- Green
- Orange
- Natural
- Lime
- Gold
- Purple
- Navy
- Black
- Maroon



MTAPE

- 100% cotton backcloth, zinc oxide white trainer's tape
- High tensile strength with excellent tackiness
- Easy unwind to core
- 1 1/2" x 15 yard rolls

1292695

32 rolls per case

\$79.99 CASE



Johnson & Johnson

5188 ATHLETIC TAPE

- High-quality, breathable porous athletic tape protects joints from sprains and injury
- Provides support to speed recovery after injury
- Packaged in SPEED PACK®
- Each roll is 1 1/2" x 15 yds
- 32 rolls per case

1420363

Case of 32

\$92.99 CASE



TAPE WRAP PREMIUM

- Excellent alternative to pre-wraps, compression wraps, wound care and fixation bandages.
- Cohesive, breathable, sweat-resistant, high tensile, lightweight and easy tearing.
- 2" x 6 yards is 24 rolls per case
- 3" x 6 yards is 16 rolls per case
- Specify color

Color Options: Black, White.

1348606

2" - Specify Color

\$58.99 EA

1348613

3" - Specify Color

\$69.99 EA



BANDAGE SCISSORS

- Flat-tipped bottom blade slips safely under tape and bandages
- Stainless steel

1078695

\$19.99 EA



TEAR-LIGHT TAPE

- Superior adhesive
- Excellent comfort
- Ideal for securing lateral knee braces as well as compression wrap or fixation bandages for padding and cold packs
- Available in 2" or 3" wide rolls

1155143

3" x 5 yd - 16 rolls/case

\$79.99 CASE



SHARK TAPE CUTTER

- Cuts through tape and bandage material with ease.
- Made of the highest quality Valox resin, fiberglass-reinforced for durability.

1082517

\$19.99 EA



2XL GYM WIPES

- EPA registered disinfectant wipes in a 900 count (extra-thick, super-absorbent 8" x 6" towelette size) designed to sanitize surfaces
- Alcohol-free, bleach-free and phenol-free. Fastest kill time in the industry
- Gym Wipes Antibacterial Towelettes, are pre-moistened, disposable, surface disinfecting wipes, that have been developed to stop cross-contamination on surfaces
- Gym Wipes will sanitize surfaces and kill 99.9% of germs that can cause illness
- Antibacterial Towelettes are proven to kill bacteria such as Salmonella choleraesuis, ATCC #10708, and E. coli, ATCC #11229

1240689	2 Reusable Buckets (900 sheets each)	\$114 ⁹⁹ EA
1240696	4 Refill Packs (900 sheets each)	\$199 ⁹⁹ EA
1249163	Wall Mount Dispenser	\$69 ⁹⁹ EA



PUREGREEN24[®] DISINFECTANT

- The first "green" hard surface disinfectant registered with the EPA.
- Recognized as a ChildSafe product by Grassroots Environmental Education
- Fast bacterial/viral/fungal kill times
- Can be applied in the presence of humans and animals
- KILLS MRSA AND STAPH
- 24hr residual protection against Staph & Salmonella
- Non-toxic, non-caustic and non-staining
- Odorless, disinfects without bleaching

1250039	32 oz. Spray Bottle	\$27 ⁹⁹ EA
1250046	1 Gallon Refill	\$77 ⁹⁹ EA



WHIZZER[®]

- Multipurpose concentrate kills HIV-1 (AIDS virus), MRSA, Hepatitis B & C, and other viruses.
- Kills strep, staph and fungus germs on contact.
- Cleaner, fungicide, mildewstat, virucide and deodorizer - all in one. Comes complete with 2 FREE Pint spray bottles.
- Economical. One ounce of concentrate mixed with water makes a gallon of full-strength disinfectant. 128 dilutions per gallon.
- Fast. Apply directly to mats, floors, walls, training tables, locker rooms, or personal items. Just wipe dry.

1155235	1 Gallon + 2 FREE Pint Spray Bottles	\$64 ⁹⁹ EA
---------	--------------------------------------	-----------------------



MATT-KLEEN[™] ALL PURPOSE DISINFECTANT CLEANER

- Helps stop the spread of skin diseases and infections
- Ideal for wrestling and gymnastic mats, training tables and shower floors
- Highly concentrated; 2 oz. makes one full gallon



1092479	Gallon	\$79 ⁹⁹ EA
---------	--------	-----------------------

ENDURACOOOL[™] INSTANT COOLING TOWEL-LG

ENDURACOOOL[™] TOWEL

- Cools instantly when wet - last up to 2 hours
 - Wearable Ultra Violet Protection Factor (UPF) 45 provides sun protection when covering the skin
 - Reusable and machine washable with detergent
- Color Options: **Blue, Pink.**

1366539	Specify Color	\$14 ⁹⁹ EA
---------	---------------	-----------------------



BIO HAZARD KIT

- Kit includes: safety shield/mask, impervious gown, Disposable gloves, bio-waste bag, antimicrobial hand wipe, Disposal bag with ties, germicidal disinfectant with dry wipe, pick-up scoop with scraper and a red Z pouch.

1205503		\$39 ⁹⁹ EA
---------	--	-----------------------



Bid #ESCNJ 17/18-31

Educational Services Commission of New Jersey

Athletic Equipment & Supplies



LIGHTED WAND

- Ideal for traffic direction in school zone
- Easy on-off with blinking or solid light
- Requires (2) size D batteries (not included)
- 16" long

1277173

\$19⁹⁹ EA



100' PENNANT STREAMERS

- Rope streamers with 18" nylon cloth pennants in a variety of colors: Blue, Green, Red, White and Yellow
- Use to dress up your field, crowd control or for cross-country events
- Sold in lengths of 100' (approx. 48 flags per 100')

1260XXX

\$17⁹⁹ EA ★



TRAFFIC SAFETY VESTS

- Class II 100% solid polyester fluorescent lime safety vest with 2" silver reflective striping and adjustable front closure
- Vest has a left bottom pocket, a left chest pocket and a right inside pocket
- Ideal for a crossing guard or for traffic safety

1276879

Size: Large

\$19⁹⁹ EA

1276886

Size: XXL

\$19⁹⁹ EA



ORANGE GAME CONES

- Flexible PVC with weighted base for added stability
- Stack easily for storage

1040814

12"

\$9¹⁹ EA ★

1040838

18"

\$11²⁹ EA ★

1040845

28"

\$30⁹⁹ EA

1040852SET

36"

\$214⁹⁹ SET OF 5

ROPE POSTS

- 5' galvanized steel post with pointed end for easy insertion into ground
- Minimum order of 6

1041392

\$42⁹⁹ EA



Sign not included

ECONO CLASSIC SIGN STAND

- Holds 24" x 36" signs (signs not included)
- Displays (2) signs per frame
- Accepts signs made of Colorplast™ foamboard, acrylic, or aluminum
- All plastic: no rust, splinters or maintenance
- White only - 11 lbs.

1292121

Size: 42"H x 27"W

\$87⁹⁹ EA



Sign not included

SIMPO SIGN II STAND

- Holds 22" x 28" signs (signs not included)
- Displays (2) signs per frame
- Blank signs quickly slide in and out and stay securely in place
- All plastic: no rust, splinters, or maintenance

1276664

Size: 36"H x 24"W

\$87⁹⁹ EA

Bid #ESCNJ 17/18-31

Educational Services Commission of New Jersey

Athletic Equipment & Supplies



MONSTER BALL CART

- Fabricated from 1" square steel
- Black powder coated finish
- Holds 15 official size basketballs

7 Year Limited Warranty

1162608 30"H x 49"W x 20"D - 30 lbs. **\$299⁹⁹** EA ★



DOUBLE MONSTER BALL CART

- Fabricated from 1" square steel
- Black powder coated finish
- Holds 30 official size basketballs

7 Year Limited Warranty

1162615 30"H x 49"W x 24"D - 54 lbs. **\$439⁹⁹** EA ★



BASKETBALL BUTLER

- Keep basketballs off the ground and ready to use
- Welded steel with powder coated finish
- Attaches to round posts up to 4 1/2" O.D. (hardware included)
- Can also be wall mounted (hardware not included)

1249156 2 Ball **\$59⁹⁹** EA
1253641 4 Ball **\$119⁹⁹** EA



**3-ROW
12 BALLS**



15 BALL CART

- Heavy duty chrome steel rods
- Solid triangular frames for strength and stability
- Non-marring casters
- Wide base design prevents tip over
- Holds 15 official size basketballs

1159639 38"H x 51"W x 19"D - 10 lbs. **\$109⁹⁹** EA ★



WALL MOUNT BALL RACK

- Black powder coated 1" steel tubing construction
- Easy to install with 4 screws (not included)
- Will hold up to 18 balls on 3 levels

1197739 40"H x 60"W x 15"D - 18 lbs. **\$139⁹⁹** EA ★



**4-ROW
16 BALLS**



HEAVY-DUTY BALL CARTS

- Welded 1" square wall tubing with 3/4" steel chrome plated, ball support arms
- Non-marring, high quality 360° swivel casters
- Extra wide wheel base avoids tipping
- Add a school or mascot name, up to (10) letters, to the end panels (lettering sold separately and is not applied by manufacturer)

5 Year Limited Warranty

Color Options: **Grey, Royal Blue, Scarlet, White.**

1048452 12 Ball Cart **\$349⁹⁹** EA
1245899 Lettering **\$79⁹⁹** EA



DOUBLE-WIDE BALL CART

- Made of 1" rugged chrome steel
- Holds 30 full size basketballs

1237634 33"H x 45"W x 24"D - 35 lbs. **\$179⁹⁹** EA ★

NEW!

WIDE BODY BALL CARTS

- Heavy duty white powder coated steel tubing
- Non-marring, hard rubber casters with a wide, no-topple base
- Designed for easy storage and removal of balls
- 12 Ball Cart - 40"W x 40"H x 16"D
- 16 Ball Cart - 40"W x 52"H x 16"D

BCART12W
BCART16W

NJ State Approved Bid #65MCE SCGRS

Metuchen/Garden State Appare

Bid Term: 5/9/18 - 5/8/20. Extended to 5/8/21

4 Row, 16 Balls **\$79⁹⁹** EA ★

Bid #ESCNJ 17/18-31

Educational Services Commission of New Jersey

Athletic Equipment & Supplies



STANDARD PORTABLE BALL LOCKER

- 1" steel tubing frame
- Holds up to 20 basketballs
- Hinged cover can be locked (lock not included)

12002100 43"H x 41"W x 24"D - 35 lbs. **\$289⁹⁹** EA ★



DOUBLE-SIDED BALL LOCKER

- Heavy duty 1" powder coated steel outside frame
- 5mm PVC coated steel mesh
- Allows for divided storage of balls
- Each side can be locked (locks not included)
- Holds up to 30 basketballs or volleyballs
- 8" back wheels allow for easy movement
- Fits through a standard doorway

1237627 44"H x 63"W x 24"D - 60 lbs. **\$369⁹⁹** EA ★ **S&H**



E-Z FOLD CART

- Aluminum square frame
- Nylon top with mesh bottom
- Holds 20 basketballs or 30 volleyballs
- Non-marring swivel casters
- Folds to only 6" wide for easy storage

MCVBCARTY 40"H x 24"W x 24"D **\$129⁹⁹** EA ★



WALL MOUNTED BALL LOCKERS

- Constructed of 1" black powder coated steel tubing
- Permanently mounts to your gym wall (hardware not included)
- Holds 6 basketballs; Double model holds 16 basketballs or 30 volleyballs
- Double model includes locking bars at the top and bottom to secure balls (locks sold separately)

1. **1173123** 66"H x 15"W x 12"D **\$169⁹⁹** EA ★
 2. **1162578** 66"H x 37"W x 12"D **\$239⁹⁹** EA ★



COMPACT BALL LOCKER

- Constructed of 1" powder coated steel tubing
- Holds up to 30 inflated balls
- Can be padlocked (lock not included)
- Larger rear wheels roll smoothly over rough terrain
- Includes mesh ball bag

1362605 46"H x 26"W x 28"D - 42 lbs. **\$189⁹⁹** EA ★



MONSTER BALL LOCKER

- Constructed of 1" powder coated steel tubing
- Holds 30 official basketballs or 40 volleyballs
- Features over sized 4" wheels for easy movement
- The top is lockable (lock not included) and contains special hinges and safety chains to prevent top from falling over

1162622 37"H x 47"W x 24"D - 75 lbs. **\$509⁹⁹** EA ★



50 BALL CART

- Constructed of 1" O.D. black powder coated steel tubing
- Heavy duty urethane swivel wheels - 2 with brakes
- 5 welded shelves make for easy assembly
- Will hold 50 official size basketballs
- Fits through standard doorways

1378673 64"H x 24"W x 61"L - 61 lbs. **\$299⁹⁹** EA ★



ALL-TERRAIN BALL LOCKER

- 7/8" steel tubing frame w/ red powder coated finish
- Durable, welded wire mesh body
- Can be padlocked (lock not included)
- Heavy duty, 16" poly spoked wheels on rear
- 4" swivel casters on front
- Holds 15 official basketballs or 25 volleyballs

1342758 38"H x 46"W x 30"D - 50 lbs. **\$419⁹⁹** EA ★



DELUXE PORTABLE BALL LOCKER

- Constructed of 3/4" powder coated steel tubing
- Lockable, hinged cover (lock not included)

STBALLCC 40"H x 40"W x 26"D - 50 lbs. **\$309⁹⁹** EA ★ **S&H**

NJ State Approved Co-op #65MCESCP's Limited New Garden State AppareBid Term: 5/9/18 to 5/8/20. Extended to 5/8/21

Bid #ESC NJ 17/18-31

Educational Services Commission of New Jersey

Athletic Equipment & Supplies



MULTI-PURPOSE EQUIPMENT WAGON

- All steel construction with pneumatic tires
- Use for carrying equipment, water containers, or field storage
- Front, rear, and side panels fold away for easy loading/unloading
- 1400 lb. weight capacity

1291766 11"H (sides) x 24"W x 48"L **\$309⁹⁹** EA ★



DELUXE TEACHING CART

- Powder coated steel frame, vinyl coated basket with foam grip
- Rubber 4" wheels with sealed ball bearings
- Locking lid that lays flat against the side
- Includes basket hanger and convenient water bottle holder
- Holds 325 tennis balls
- Basket Height - 42 1/2"H
- Top Basket - 19" W x 23"L

1342550 **\$259⁹⁹** EA ★



COLOSSAL VOLLEYBALL CART

- Nylon basket includes side pockets for storage
- Holds 40 volleyballs
- Black only

1274417 38"H x 42"W x 32"D **\$199⁹⁹** EA



BATTING PRACTICE BALL CART

- Constructed of 1.5" O.D. powder coated steel
- Large capacity basket
- Oversized "no flat" tires

1378683 Batting Practice Ball Cart **\$229⁹⁹** EA ★
1375102 Replacement Wheel **\$24⁹⁹** EA ★



MULTI-PURPOSE EQUIPMENT CART

- Constructed of 1" powder coated steel tubing
- Great for carrying PE and baseball equipment
- Polyester bag measures 24"H x 24"W x 12"D

1197655 46"H x 29"W x 30"D - 29 lbs. **\$204⁹⁹** EA ★



RACQUET CART

- Galvanized steel construction
- Holds up to 64 tennis rackets or 100 table tennis paddles
- Non-marring casters for easy transport

1690XXXX 32"L x 14"W x 28"H **\$84⁹⁹** EA ★



LARGE EQUIPMENT CART

- Safe, secure, highly visible wire storage center
- 2" square grid, nickel chrome finish
- Double door opens a full 270° and is lockable
- Comes with (4) 5" polyurethane swivel casters
- Interior shelves sold separately
- Assembly required - 1000 lb. capacity

92448XXX **\$99⁹⁹** EA ★
92449XXX Shelf 48"W x 24"D **\$99⁹⁹** EA



SCOOTER BOARD/CONE CART

- 1" diameter, powder coated silver, steel tubing
- Holds up to (28) 12" scooters with or without handles
- Large 10" rubber wheels

1375089 47"H x 32"W x 19"D **\$203⁹⁹** EA ★



CONE CART

- Holds (60) 12" pvc or (200) plastic cones
- 1" diameter steel tube frame w/ silver powder coated finish

1362619 45"H x 26"W x 16"D - 30 lbs. **\$152⁹⁹** EA ★

Bid #ESCNJ 17/18-31

Educational Services Commission of New Jersey

Athletic Equipment & Supplies



BULK STORAGE CART

- Transport most anything in this heavy-duty PVC cart
- Durable plastic bottom board will hold laundry, balls or equipment
- Rolls easily

1366522 17"H x 47"W x 23"D - 47 lbs. \$299⁹⁹ EA

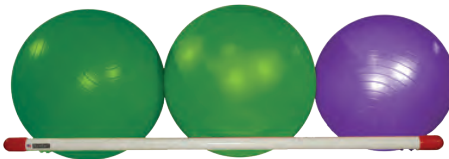

STABILITY BALL WALL RACK

- Wall-mounted stability ball rack (hardware not included)
- Conveniently holds 3 medium or 2 large fitness balls

1369556 55"W x 18"D - 6 lbs. \$69⁹⁹ EA



STABILITY BALL CART

- Stores and safely transports stability balls with a diameter of 16" or larger, plus jump ropes, exercise bands and resistance tubes
- Lightweight PVC, yet strong, durable and maintenance free
- Roll lock casters secure cart in place with the push of a lever
- Easily passes through a standard doorway

1257557 67"H x 67"W x 19"D \$279⁹⁹ EA S&H



P.E. RECESS CART

- Store and transport equipment and balls frequently used during recess
- Holds up to (30) basketballs, soccer balls, 8.5" playground balls or volleyballs
- Also holds (100) jump ropes and (50) hoops of various sizes

1188318 72"H x 63"W x 19"D \$339⁹⁹ EA ★



FITNESS STEP CART

- Large capacity storage rack and transporter for fitness steps and resistance tubes
- Lightweight and durable
- This cart will safely store up to (32) 4" steps or (16) 6" steps plus resistance tubes
- Features include heavy-duty, ball bearing, swivel, non-marring casters with a roll lock feature
- Easily goes through standard doorway

1188332 60"H x 45"W x 19"D \$269⁹⁹ EA

JUMP ROPE/HOOP RACK

- Stores and transports over 120 jump ropes (up to 10' long) plus hoops
- Large base for increased stability
- Bar heights of 56", 62" and 68" allow children and adults to easily access the correct size jump rope
- Easily goes through standard doorway



1188325 68"H x 27"L x 19"D \$179⁹⁹ EA



1. Single

2. Divided

LARGE LAUNDRY CARTS

- Bag is constructed of heavy duty canvas and removes easily with hook and loop fasteners
- Chrome plated steel frame
- Load capacity: 7 bushels, 51 gallons, 100 lbs.
- Support bars under bag
- 2½" casters, two with brake and 4 caster bumpers
- Outer dimensions: 36½"H x 38½"W x 24¾"D
- Inner dimensions: 23"H x 30½"W x 19½"D
- Assembly required

Lifetime Warranty

1. 1378279 Single Compartment \$219⁹⁹ EA
 2. 1378280 Divided Compartment \$239⁹⁹ EA



MULTI-TERRAIN ALL PLAY CART

- Large rubber wheels on back
- Non-marring swivel, locking casters on front
- Cart will transport up to (24) soccer balls or basketballs plus jump ropes, hoops and more
- Includes (2) heavy-duty baskets

1257526 65"H x 52"W x 24"D \$399⁹⁹ EA

SHOW YOUR OPPONENTS THAT THEY ARE IN YOUR HOUSE!



Wall Mat Construction

- Used primarily behind basketball goals to absorb impact and reduce injuries
- Constructed of 1/2" Novaply wood backing with your choice of either Crosslink Polyethylene Foam, 100 ILD High Density Polyurethane or combine both for a dual density pad
- Covered in 18 oz. vinyl with a 1" lip at the top and bottom for attachment to the wall
- Corner round molding or aluminum channel (not included) may be used to cover bolt heads after installation installation hardware not included)

Combine Art With Performance

- Special, durable inks are used that produce extreme and intense, life size outdoor quality images
- The vinyl is protected with a special lamination process to add durability and prevent fading

It's Quick and Easy

- Send us a (copyright free) high resolution digital vector file or choose from our library of in-house mascot images
- For an additional charge, our designers will create or enhance your existing artwork
- All images and additional charges will be sent to you for approval prior to printing on pads

WALL PADS WITH GRAPHICS

13/8" Crosslink Polyethylene

20028347	2' x 5' x 13/8"	\$207 ⁹⁹	EA	
20028353	2' x 6' x 13/8"	\$228 ⁹⁹	EA	
20028360	2' x 7' x 13/8"	\$261 ⁹⁹	EA	

2" High Density Polyurethane

20028351	2' x 5' x 2"	\$217 ⁹⁹	EA	
20028358	2' x 6' x 2"	\$239 ⁹⁹	EA	
20028364	2' x 7' x 2"	\$281 ⁹⁹	EA	

2 1/2" Combination Wall Pads

20028349	2' x 5' x 2 1/2"	\$228 ⁹⁹	EA	
20028355	2' x 6' x 2 1/2"	\$249 ⁹⁹	EA	
20028362	2' x 7' x 2 1/2"	\$292 ⁹⁹	EA	

WALL PADS WITHOUT GRAPHICS*

13/8" Crosslink Polyethylene

20028348	2' x 5' x 13/8"	\$109 ⁹⁹	EA	
20028354	2' x 6' x 13/8"	\$130 ⁹⁹	EA	
20028361	2' x 7' x 13/8"	\$152 ⁹⁹	EA	

2" High Density Polyurethane

20028352	2' x 5' x 2"	\$130 ⁹⁹	EA	
20028359	2' x 6' x 2"	\$152 ⁹⁹	EA	
20028365	2' x 7' x 2"	\$164 ⁹⁹	EA	

2 1/2" Combination Wall Pads

20028350	2' x 5' x 2 1/2"	\$140 ⁹⁹	EA	
20028356	2' x 6' x 2 1/2"	\$164 ⁹⁹	EA	
20028363	2' x 7' x 2 1/2"	\$174 ⁹⁹	EA	



CUT OUT FOR WALL PADS AND I-BEAM PADS



WALL PAD ACCESSORIES

6870YXXX	6" Aluminum Channeling	\$59 ⁹⁹	SET	
20028346	Cut Out	\$87 ⁹⁹	EA	
20028345	Corner Pad	Call for Pricing	EA	
20028357	I-Beam Pad For Up to 8" Face	\$325 ⁹⁹	EA	

COLOR CHOICES: Choose from 14 school colors, in solids or alternating panel colors.

Due to dye lots and natural variations, vinyl colors may vary slightly if ordered at separate times.



ENHANCE THE SAFETY & APPEARANCE OF YOUR GYM AND PLAY AREAS!

LET US GUIDE YOU THROUGH THE ENTIRE ORDERING PROCESS!



18oz. vinyl



WALL PADS

- Provides protection for indoor impact areas
- Perfect for basketball courts, gymnastics areas, wrestling facilities, rehab centers and more
- Installs easily and the brightly colored pads will enhance the appearance of your facility
- Made of 7/16" thick wood backing, 18 oz. vinyl, and have a 1" lip at the top and bottom for attachment to the wall
- We recommend our Aluminum Channeling for mounting your wall pads, but can be bolted in place - hardware not included
- Covered material meets California Fire Marshall's specifications for flammability
- Available colors: **Black, Columbia Blue, Grey, Kelly Green, Maroon, Medium Green, Midnight Green, Navy Blue, Orange, Purple, Red, Royal Blue, Sport Grey/Charcoal, Tan, Vegas Gold, White or Yellow**
- You may also order a combination of colors
- Please contact us for pricing on custom wall pads, column pads or cut outs

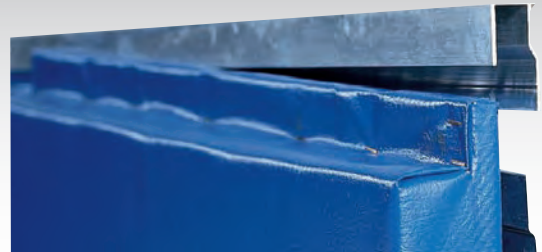

ALUMINUM CHANNELING FOR WALL PADS

- Fastest and easiest method for attaching wall padding to your walls
- Pads fit into the channeling securely and lock-in at the top for a smooth, neat appearance (no ugly bolts or screws to cover up)
- Worn or damaged pads can be easily removed and replaced one panel at a time by simply removing the top channel
- Includes top and bottom channels
- Sold in 6' lengths

6875YXXX	2' x 5' x 13/8" Cross Link Polyethylene	\$127 ⁹⁹ EA
6876YXXX	2' x 6' x 13/8" Cross Link Polyethylene	\$143 ⁹⁹ EA
6877YXXX	2' x 7' x 13/8" Cross Link Polyethylene	\$159 ⁹⁹ EA
6872YXXX	2' x 5' x 2" High Density Urethane	\$137 ⁹⁹ EA
6873YXXX	2' x 6' x 2" High Density Urethane	\$159 ⁹⁹ EA
6874YXXX	2' x 7' x 2" High Density Urethane	\$176 ⁹⁹ EA
1045826	1045826	\$52 ⁹⁹ EA



FLAME RETARDANT WALL PADS

- Class A pads are constructed of 7/16" OSB Board, with 2" highly flame resistant polymerized open cell foam and covered with 16 oz. FR rated vinyl
- Pads have a 1" lip top and bottom for attachment to the wall
- Corner round molding or aluminum channel (**not included**) may be used to cover bolt heads after installation (**installation hardware is not included**)
- Pads comply with the standards set forth by ASTM E84
- Meets NFPA 255, UL 723, ANSI 2.5 and UBC 8-1 (42-1)
- Available colors: Black, Columbia Blue, Dark Green, Grey, Kelly Green, Maroon, Navy Blue, Orange, Purple, Red, Royal Blue, Tan, White and Yellow

CERTIFICATE OF COMPLIANCE



With Graphics

1248029	2' x 5' x 2"	\$249 ⁹⁹ EA	
1248036	2' x 6' x 2"	\$291 ⁹⁹ EA	
1248043	2' x 7' x 2"	\$336 ⁹⁹ EA	

Without Graphics

1247992	2' x 5' x 2"	\$174 ⁹⁹ EA	
1248005	2' x 6' x 2"	\$207 ⁹⁹ EA	
1248015	2' x 7' x 2"	\$228 ⁹⁹ EA	



I-BEAM PADS

- Designed to minimize the risk for injury from contact with a steel support I-beam
- Crafted to provide maximum protection, durability and ease of installation
- Pads are 6' H, covered with 18 oz. vinyl and filled with 4" high density polyfoam
- Fits beams up to 8" wide
- Available in **Black, Columbia Blue, Dark Green, Grey, Kelly Green, Maroon, Navy Blue, Orange, Purple, Red, Royal Blue, Tan, White or Yellow**
- Please specify color

G862YXXX \$353⁹⁹ EA



COLUMN PADS

- Provide protection against collisions with support posts and poles
- Easily installed and enhances the appearance of your facility
- Available for both free-standing and in-wall supports

Call for more information and pricing on our column pads.



MADE IN 8" WIDE SECTIONS

STAGE PADS

- If your gymnasium is also used as an auditorium or theater, you need our stage pads to reduce the chance of injury
- Custom made to your specific application
- The inboard side of the fold is beveled so the edge of the stage is fully padded
- Fastener strips are included to prevent the pad from shifting, sliding or detaching while in use
- Manufactured using 1 3/8" crosslink polyethylene foam covered in 18 oz. vinyl
- Available in **Black, Columbia Blue, Dark Green, Grey, Kelly Green, Maroon, Navy Blue, Orange, Purple, Red, Royal Blue, Tan, White or Yellow**
- Please specify color

G861YXXX \$19⁹⁹ SQ.FT

COLOR CHOICES: Choose from 14 school colors, in solids or alternating panel colors.
Due to dye lots and natural variations, vinyl colors may vary slightly if ordered at separate times.

N.J. State Approved Co-op #6514GESCRRS Metuchen/Garden State Apparel Bid Term: 5/9/18 - 5/8/20: Extended to 5/8/21



BUY THE PACK & \$SAVE!!

PHYSICAL EDUCATION



RECESS PACKAGE

Package Includes:

- 6 cones (6")
- 1 set of throwdown bases
- 1 poly bat (29 1/2")
- 6 plastic baseballs
- 6 flying discs
- 2 Poof foam footballs
- 2 Poof foam soccerballs
- 1 Poof foam basketball
- 4 rubber basketballs (2 each official, junior)
- 2 size 4 rubber soccerballs

- 2 Enduro playground balls (8 1/2")
- 1 Fun Gripper football (8 1/2")
- 10 segmented jump ropes (4 each 7', 8' and 2 each 16')
- 4 hi-bounce spongy balls
- 1 hand inflater
- 1 mesh ball bag

1179354 54 Pieces \$269⁹⁹ SET ★



SIX-COLOR STARTER SET

Package includes: One Blue, Green, Orange, Purple, Red and Yellow of each item.

- Junior footballs
- Junior basketballs
- Size 4 soccer balls
- Official volleyballs
- 8 1/2" playground balls
- 6" color cones
- Mesh bags

99916XXX 42 Pieces \$359⁹⁹ PACK ★



DELUXE FIELD DAY PACKAGE

Includes everything needed to have a great day of fun-filled activities.

Package Includes:

- 12 Plastic batons
- 12 Potato sacks
- 1 Tug-o-war rope (75' long)
- 6 Game cones (12" high)
- 12 Low profile field cones
- 12 Flying discs
- 12 Plastic hoops (30" diameter)
- 24 Foam hoop holders

- 200 Latex balloons
- 6 Playground balls (8 1/2")
- 1 Stopwatch
- 150 Award ribbons (50 each 1st-2nd-3rd place)

1251562 398 Pieces \$429⁹⁹ PACK ★

HAVE A BALL VALUE PACK

Package includes:

- 12 VOIT® 8 1/2" colored playground balls
- 6 VOIT® Enduro CB2 official basketballs
- 6 MacGregor® size 5 rubber soccer balls

- 2 VOIT® Soft Shot rubber volleyballs
- 2 VOIT® CF9 senior size footballs

999912XX 28 Pieces \$239⁹⁹ SET ★



TUFF FOAM BALL PACKAGE

Package includes:

- 6 Voit 8 1/4" "Special" Tuff balls
- 6 Voit 6 1/4" "Softi" Tuff balls
- 6 Voit 5" Mini Tuff balls
- 3 Voit 6 1/4" Tuff dodgeballs
- 3 Voit Tuff soccerballs - size 4

2 Year Limited Warranty



Add fun and excitement to your class and playground with our color management system. Use our system and provide each group with its own unique color. Eliminate arguments over whose equipment was left on the field or whose turn it is to play. If it's your color, it's yours. Color My Class' products are available in **Blue, Green, Orange, Purple, Red and Yellow.** Prism packs include - 1 of each color.



MacGregor

MULTICOLOR BASKETBALLS

- Durable rubber construction
- Deep channels and enhanced pebbling
- Indoor/Outdoor use

Color Options: **Blue, Green, Orange, Purple, Red, Yellow.**

936021	Official Size (29.5")	\$12 ⁴⁹	EA ★
93600	Official Size Prism Pack	\$66 ⁹⁹	PACK OF 6 ★
935021	Intermediate Size (28.5")	\$12 ⁴⁹	EA ★
93500	Intermediate Size Prism Pack	\$63 ⁹⁹	PACK OF 6 ★
934021	Junior Size (27.5")	\$12 ⁴⁹	EA ★
93400	Junior Size Prism Pack	\$60 ⁹⁹	PACK OF 6 ★
1308099	Colt (25.5") Prism Pack	\$58 ⁹⁹	PACK OF 6 ★
1268935	Lil' Champ (22") Prism Pack	\$56 ⁹⁹	PACK OF 6 ★



MacGregor

MULTICOLOR SOCCERBALLS

- Top quality rubber construction
- Nylon windings and butyl bladder for superior strength and air-retention

94500	Size 5 Prism Pack	\$60 ⁹⁹	PACK OF 6 ★
94502	Size 5 Blue	\$12 ⁷⁹	EA ★
94400	Size 4 Prism Pack	\$53 ⁹⁹	PACK OF 6 ★
94402	Size 4 Blue	\$11 ⁷⁹	EA ★
94300	Size 3 Prism Pack	\$50 ⁹⁹	PACK OF 6 ★



MacGregor

MULTICOLOR FOOTBALLS

- Durable rubber construction
- Pebble grain exterior with raised laces for a superior grip
- Nylon windings and butyl bladder provides added strength and air-retention

95900	Official Size Prism Pack	\$70 ⁹⁹	PACK OF 6 ★
95925	Official Size Yellow	\$12 ⁵⁹	EA ★
95700	Youth Size Prism Pack	\$67 ⁹⁹	PACK OF 6 ★
95725	Youth Size Yellow	\$11 ⁹⁹	EA ★
95600	Junior Size Prism Pack	\$65 ⁹⁹	PACK OF 6 ★
95625	Junior Size Yellow	\$11 ⁵⁹	EA ★



MacGregor

MULTICOLOR VOLLEYBALLS

- Durable rubber construction
- Regulation size and weight
- Nylon windings and butyl bladder construction provides added strength and increased air-retention

91300	Prism Pack	\$60 ⁹⁹	PACK OF 6 ★
--------------	------------	--------------------	-------------



MacGregor
COLOR MY CLASS' XTRA™

Step Into The Next Generation!!

- Launch your programs to the next level with these vibrantly colored balls
- Eye-popping colors make these balls easy to track
- Synthetic leather balls with PVC cushioned covers feature a swirling 3-D hologram
- Footballs have an "E-Z" grip material on each end that enhances catching and throwing
- Each set includes 1 of each neon color: **Blue, Green, Orange, Purple, Red and Yellow**

1255829	Junior Football	\$71 ⁹⁹	SET OF 6 ★
1255843	Size 4 Soccer Ball	\$71 ⁹⁹	SET OF 6 ★
1255850	Size 5 Soccer Ball	\$71 ⁹⁹	SET OF 6 ★
1255836	Regulation Volleyball	\$71 ⁹⁹	SET OF 6 ★



Voit

ENDURO CS3 KICKBALL

- The original 8 1/2" playground kickball
- Nylon wound construction provides increased shape and air retention
- Durable but soft rubber cover for all your tough kicking activities

VCS3HXXX	Prism Pack	\$59 ⁹⁹	SET OF 6 ★
1282108			



Voit

4-SQUARE UTILITY BALLS

- 8 1/2" nylon wound utility ball for increased air and shape retention
- Designed for the game of 4-Square or for kicking, striking and hard impact activities
- Prism Pack includes 1 of each color: **Blue, Green, Orange, Purple, Red and Yellow**

1026634	Prism Pack	\$37 ⁹⁹	SET OF 6 ★
----------------	------------	--------------------	------------



Voit

LIGHT SPIKE

- Double knit soft polyester fabric cover allows players to practice skills without discomfort
- 30% lighter than official volleyball

1342536		\$13 ⁹⁹	EA ★
----------------	--	--------------------	------



Voit



PHYSICAL EDUCATION

PLAYGROUND BALLS

- The most widely used playground ball in the country!
- Please specify color where applicable

	Diameter	Color Options	
VP65HXXX	5"	Red Only	\$4 ⁹⁹ EA ★
VP66HXXX	6"	Blue, Green, Orange, Purple, Red, Yellow	\$5 ³⁹ EA ★
VP67HXXX	7"	Red Only	\$5 ⁹⁹ EA ★
VP685HXX	8 1/2"	Blue, Green, Orange, Purple, Red, Yellow	\$6 ⁴⁹ EA ★
VP610HXX	10"	Blue, Green, Orange, Purple, Red, Yellow	\$7 ³⁹ EA ★
VP613HXX	13"	Red Only	\$11 ⁹⁹ EA ★
VP616HXX	16"	Red Only	\$15 ⁹⁹ EA ★

PLAYGROUND BALL PRISM PACKS

- All prism packs include one of each color: Blue, Green, Orange, Purple, Red and Yellow

1369484	6"	\$31 ⁹⁹ SET OF 6 ★
1033472	8 1/2"	\$37 ⁹⁹ SET OF 6 ★
1369485	10"	\$42 ⁹⁹ SET OF 6 ★

2-PLY PLAYGROUND BALLS!



COLOR MY CLASS® P.G. SOF'S

- Roto-molded from foamed vinyl
- Combine the best features of playground balls and coated foam balls
- Supple, squeezable, sting-free and bounce like a rubber ball
- Vary the diameter of each ball for desired softness and bounce
- Each set includes 1 of each color: Blue, Green, Orange, Purple, Red and Yellow

1064957	8" Diameter Special	\$40 ⁹⁹ SET OF 6
1251913	7" Diameter Allround	\$38 ⁹⁹ SET OF 6
1251920	6" Diameter Playball	\$34 ⁹⁹ SET OF 6
1255119	9 1/4" Long Football	\$41 ⁹⁹ SET OF 6
1255102	7 1/2" Long Football	\$37 ⁹⁹ SET OF 6



Voit THE RAINBOW 48 PACK

- Pack includes forty eight 8 1/2" playground balls
- 8 each Blue, Green, Orange, Purple, Red and Yellow

BUY THE PACK & SAVE!

1233179

\$269⁹⁹ PACK OF 48 ★



Voit

YELLOW ENDURO SERIES PLAYGROUND BALLS

KICK 'EM - BAT 'EM - BOUNCE 'EM

- Designed for tough playground activities - kicking, batting, bouncing
- Nylon wound construction adds durability and air and shape retention
- Harder than standard playground balls
- Not recommended for bombardment activities

VP66HNYL
VP610HNY

NJ State Approved Co-op #65MCESCCPS Metuchen/Garden State AppareBid Term: 5/9/18 - 5/8/20: Extended to 5/8/21

10"

\$11³⁹ EA ★



Voit

8 1/2" ENDURO SERIES PLAYGROUND BALLS

- Our toughest most durable playground ball!
- Nylon wound for more durability and shape retention
- Designed to withstand all high-impact playground activities
- Should not be used for bombardment games

Color Options: Blue, Green, Orange, Purple, Red, Yellow.

EXTRA TOUGH!

154470
1369483

Specify Color
Prism Pack

\$7⁹⁹ EA ★
\$45⁹⁹ SET OF 6 ★



CAGEBALLS

- A TRADITIONAL FAVORITE!
- Multi-color ball for multi-player action
- Super-duty nylon cover over a durable, vinyl bladder with sonic welded seams
- Helps develop coordination and teamwork
- Inflate with a high powered inflator/deflator
- The bigger the ball, the more players you can use



Complete Set

CAGEUN24X	24" (2 lbs. 2 oz.)	\$42 ⁹⁹	EA ★
CAGEUN30X	30" (3 lbs. 1 oz.)	\$49 ⁹⁹	EA ★
CAGEUN36X	36" (6 lbs. 10 oz.)	\$72 ⁹⁹	EA ★
CAGEUN48X	48" (7 lbs. 6 oz.)	\$129 ⁹⁹	EA ★
CAGEUN60X	60" (11 lbs. 5 oz.)	\$184 ⁹⁹	EA ★
CAGEUN72X	72" (17 lbs. 3 oz.)	\$259 ⁹⁹	EA ★

Cover Only

CAGE24CO	24"	\$21 ⁹⁹	EA ★
CAGE30CO	30"	\$25 ⁹⁹	EA ★
CAGE36CO	36"	\$37 ⁹⁹	EA ★
CAGE48CO	48"	\$64 ⁹⁹	EA ★
CAGE60CO	60"	\$89 ⁹⁹	EA ★
CAGE72CO	72"	\$139 ⁹⁹	EA ★

Bladder Only

CAGEBL24	24"	\$22 ⁹⁹	EA ★
CAGEBL30	30"	\$27 ⁹⁹	EA ★
CAGEBL36	36"	\$39 ⁹⁹	EA ★
CAGEBL48	48"	\$67 ⁹⁹	EA ★
CAGEBL60	60"	\$99 ⁹⁹	EA ★
CAGEBL72	72"	\$159 ⁹⁹	EA ★

POOF

FOAM BALLS

- Students successfully learn skills by eliminating the fear
- Spongy foam core with a durable, moisture resistant outer skin
- Great for restricted areas indoors or out
- Colors vary



3169	7 1/2" Size 3 Soccer Ball	\$12 ⁹⁹	EA
3166	7" Size 3 Junior Basketball	\$12 ⁹⁹	EA
3168	3/4 Size 9 1/2" Football	\$9 ⁹⁹	EA
1378321	Set of 3 Balls (1 of Each Ball)	\$30 ⁹⁹	SET OF 3

PLAYOFF TURBO FOAM FOOTBALL

- Unique foam football is grooved to make it easier to grip and throw
- Non-toxic powder construction makes it environmentally safe
- Dense construction for better performance and aerodynamics
- Colors may vary



40199XX	8 1/2" Long	\$7 ⁹⁹	EA
----------------	-------------	-------------------	----



OMNIKIN® MULTICOLOR BALLS

- Bright and ultra-light
- Use indoors and outdoors - throw, bounce, kick them
- Change traditional activities into giant-sized activities
- Includes nylon cover and 1 latex bladder

3 Year Limited Warranty

24634	40" Ball (2 lbs. 6 oz.)	\$244 ⁹⁹	EA
24632	33" Ball (1 lb. 7 oz.)	\$183 ⁹⁹	EA
1313888	24" Ball (1 lb.)	\$83 ⁹⁹	EA
1071450	40"-48" Replacement Bladder	\$55 ⁹⁹	EA
1071467	33" Replacement Bladder	\$43 ⁹⁹	EA
1313895	24" Replacement Bladder	\$25 ⁹⁹	EA

KIN-BALL® SPORT BALLS

- **FAST PACED EXCITING TEAM SPORT!**
- 3 teams of 4 players each try to keep this super lightweight ball from hitting the ground or the gym wall in this constant action game
- When a team has possession of the ball, every member of that team will touch the ball before serving to another team
- Promotes cooperation and teamwork
- Develops physical, social and critical thinking skills while being just plain fun

3 Year Limited Warranty

24640	48" KIN-BALL® Sport (Pink)	\$305 ⁹⁹	EA
20020170	48" KIN-BALL® Sport (Black)	\$305 ⁹⁹	EA
1071450	40"-48" Replacement Bladder	\$55 ⁹⁹	EA



OMNIKIN® INFLATOR

- Made of lightweight, durable plastic
- Includes 3 adapters and dual handles
- Use on any large inflatable

24630XXX	4 1/2 HP	\$264 ⁹⁹	EA
-----------------	----------	---------------------	----

NEW!

GRIPPEE BALLS

- This patented ball could be the easiest ball to grip we have ever seen
- The patented design creates a textured cover for a sure grip every time
- Outer cover is polyurethane windings making it extremely soft and durable
- Not only a GREEN product, but also a GREEN manufacturing process

2 Year Limited Warranty

1395256	5" Prism Pack	\$69 ⁹⁹	SET OF 6 ★
1395257	6 1/4" Prism Pack	\$87 ⁹⁹	SET OF 6 ★
1395258	7" Prism Pack	\$109 ⁹⁹	SET OF 6 ★
1395259	8 1/4" Prism Pack	\$159 ⁹⁹	SET OF 6 ★



JELLY BALL

GRAB - PULL - BOUNCE - YEOW!

- Non-threatening elastic ball for squeezing, kicking and catching
- Super-light, super-tough material can take anything kids can dish out
- Vary inflation to adjust from low to medium bounce
- Features a re-inflatable valve and straw attachment for easy inflation
- Includes 1 of each color: Blue, Green, Orange, Purple,



1275025	9" Prism Pack	\$43 ⁹⁹	SET OF 6 ★
----------------	---------------	--------------------	------------



SOFT-LOW BOUNCE TUFF BALLS

- Our coated foam balls are soft, squeezable and built to last
- Durable enough for all playground and indoor games
- Builds confidence and enhances skill development
- Easy to catch, grip and control
- Tear-resistant cover is washable, non-toxic and can be disinfected

2 Year Limited Warranty

Color Options: **Blue, Green, Orange, Purple, Red, Yellow.**

44075	5" "Mini Playball" (Specify Color)	\$13 ⁹⁹ EA ★
1181555	5" "Mini Playball" (Prism Pack)	\$64 ⁹⁹ SET OF 6 ★
440011	6 1/4" "Softi" (Specify Color)	\$14 ⁹⁹ EA ★
1179286	6 1/4" "Softi" (Prism Pack)	\$78 ⁹⁹ SET OF 6 ★
1369513	7" "Seven" (Specify Color)	\$17 ⁹⁹ EA ★
1369579	7" "Seven" (Prism Pack)	\$98 ⁹⁹ SET OF 6 ★
440101	8 1/4" "Special" (Specify Color)	\$25 ⁹⁹ EA ★
1236149	8 1/4" "Special" (Prism Pack)	\$148 ⁹⁹ SET OF 6 ★

AVAILABLE IN 4 SIZES!



PHYSICAL EDUCATION



TUFF MEDIUM DENSITY SPECIALTY BALLS

- Firmer and larger than the Softi, yet appropriately sized for children
- Recommended for activities requiring greater ball action and weight than the Softi can provide

2 Year Limited Warranty

4407	Yellow All Around 7" dia.	\$23 ⁹⁹ EA ★
4406	Red Playball 6 1/2" dia.	\$19 ⁹⁹ EA ★



TUFF COATED FOAM SOCCER BALL

- Durable ball, perfect to learn lead-up skills
- Features high-density foam covered in "tuff" vinyl

2 Year Limited Warranty

Color Options: **Blue, Green, Orange, Purple, Red, Yellow.**

44017	Size 4 (Specify Color)	\$28 ⁹⁹ EA ★
1243987	Size 4 (Prism Pack)	\$154 ⁹⁹ SET OF 6 ★
1369585	Size 5 (Specify Color)	\$29 ⁹⁹ EA ★
1369584	Size 5 (Prism Pack)	\$159 ⁹⁹ SET OF 6 ★



TUFF 6 1/4" DODGEBALL

- Soft, slow moving and easy to grip
- Perfect for target games (bowling pins, critters, cones) and dodgeball

• Soft, low density foam covered in a "Tuff" outer cover

2 Year Limited Warranty

44020	Black	\$13 ⁹⁹ EA ★
1369507	Prism Pack	\$76 ⁹⁹ SET OF 6 ★



TUFF COATED FOAM FOOTBALLS

- Lightweight, yet heavy enough for quality football action

2 Year Limited Warranty

Color Options: **Blue, Green, Orange, Purple, Red, Yellow.**

VTFBTL10	9 3/4" Junior (Specify Color)	\$21 ⁹⁹ EA ★
1243925	9 3/4" Junior (Prism Pack)	\$123 ⁹⁹ SET OF 6 ★
VTFMFB91	8 1/2" Mini (Specify Color)	\$18 ⁹⁹ EA ★
1243864	8 1/2" Mini (Prism Pack)	\$101 ⁹⁹ SET OF 6 ★



6 1/4" NEON "SOFTI" TUFF BALLS

- Soft, squeezable coated foam balls in exciting neon colors
- Soft enough for indoor play and "tuff" enough for rugged playground activities

• Easy to catch, grip and control

2 Year Limited Warranty

1274587	6 1/4" Prism Pack	\$274 ⁹⁹ SET OF 6 ★
---------	-------------------	--------------------------------



NEW!

BOUNCEE FOAM BALLS

- High density coated foam balls are lively and bouncier
- Use for teaching dribbling, kicking and bouncing lead up skills
- Tear-resistant cover is washable, non-toxic and can easily be disinfected
- Each pack includes 1 of each color: Blue, Green, Orange, Purple, Red and Yellow

2 Year Limited Warranty

1395254	6 1/4" Prism Pack	\$94 ⁹⁹ SET OF 6 ★
1395255	8 1/4" Prism Pack	\$189 ⁹⁹ SET OF 6 ★

BEST SELLER



DELUXE PARACHUTES

- WE'VE RAISED THE STANDARDS!
- Features durable, reinforced handles
- High quality nylon parachutes with an air-flow mesh center
- Perfect cool down activity for children with Autism Spectrum Disorder
- Storage bag included

1040005	6' Dia. - 8 Handles	\$26 ⁹⁹ EA ★
1040012	12' Dia. - 12 Handles	\$61 ⁹⁹ EA ★
1255874	20' Dia. - 16 Handles	\$132 ⁹⁹ EA ★
1040029	24' Dia. - 20 Handles	\$163 ⁹⁹ EA ★
1040036	30' Dia. - 24 Handles	\$234 ⁹⁹ EA ★
1255881	35' Dia. - 28 Handles	\$326 ⁹⁹ EA ★
1255898	45' Dia. - 32 Handles	\$459 ⁹⁹ EA ★



WEIGHTED BOWLING SET

- This set plays almost like the real thing
- The weighted pins react more realistically when hit
- Set includes ten 15"H pins weighing about 10 oz. each, one 4 1/2 lb. ball, set up sheet and score pad

1248050 **\$101⁹⁹ SET ★**



LIGHTWEIGHT BOWLING SET

- Ideal for teaching the fundamentals of bowling to beginners
- Each set includes ten 15"H, lightweight, 5 oz. hollow pins, 5 lb. rubber ball, set-up sheet and score pad

1041149	Complete Set	\$91 ⁹⁹ SET ★
PPS527XXY	Replacement 5 lb. Ball	\$44 ⁹⁹ EA ★
PPS528XXY	Replacement 2 1/2 lb. Ball (2 Finger Holes)	\$26 ⁹⁹ EA ★
PPS524XX	Replacement Set of Pins, Set-Up Sheet and Score Pad	\$50 ⁹⁹ SET ★



ROLL OUT BOWLING LANE

- Store this colorful 42"W x 20'L vinyl mat and roll it out when needed
- Lies flat after being brought out of storage
- Printed pin placement graphics assures pins will be set up correctly
- The printed directional arrows will have bowlers throwing strikes in no time
- Pins and balls sold separately

1274974 **\$149⁹⁹ EA ★**



ECONOMY TUG-O-WAR ROPE

- 1" diameter, top grade manila rope
- 72" loop and braided at each end

1040968	50'	\$96 ⁹⁹ EA ★
1040975	75'	\$139 ⁹⁹ EA ★
1040951	100'	\$153 ⁹⁹ EA ★



TEAMWORK TREKKERS

- WALK THIS WAY!
- Designed to develop balance, coordination, agility and cooperation
- Students must communicate and work together in order to walk together
- Features a soft foam bottom that will not harm gym floors
- Use indoors or outdoors
- Recommended for ages 4 and up
- 5 1/2" wide

1026535	2-Person Trekker 36" L	\$76 ⁹⁹ PR ★
1026542	4-Person Trekker 59" L	\$127 ⁹⁹ PR ★
1026559	6-Person Trekker 90" L	\$178 ⁹⁹ PR ★



HOPPERS

- A fun way to develop leg strength and balance
- Use as an aerobic workout indoors or out
- Heavy duty PVC cover is washable
- Available in 2 sizes
- 18" for ages 3 to 6 - 24" for ages 6 to 10 - 30" for ages 10-15

1397253	18" Hopper - Prism Pack	\$159 ⁹⁹ SET OF 6 ★
1039986	18" Hopper - Tie Dye	\$30 ⁹⁹ EA ★
1256772	18" Hopper - Yellow	\$30 ⁹⁹ EA ★
1397254	24" Hopper - Prism Pack	\$179 ⁹⁹ SET OF 6 ★
1039993	24" Hopper - Tie Dye	\$32 ⁹⁹ EA ★
1256789	24" Hopper - Red	\$32 ⁹⁹ EA ★
1397255	30" Hopper - Prism Pack	\$199 ⁹⁹ SET OF 6 ★
1397256	30" Hopper - Tie Dye	\$34 ⁹⁹ EA ★

Bid #ESCNJ 17/18-31

Educational Services Commission of New Jersey

Athletic Equipment & Supplies

HEAVYWEIGHT SASH ROPES

- Thick sash cord jointed into well shaped hollow handles



2546XXXX	8'	\$5.49 EA ★
2547XXXX	9 1/2'	\$6.99 EA ★
2548XXXX	16'	\$7.99 EA ★



HANDLELESS JUMP ROPES

- These nylon braided ropes turn in your hand without handles
- The danger of injury from a hard plastic handle is eliminated
- Each set includes 1 of each color: Blue, Green, Orange, Purple, Red and Yellow

1172522	7'	\$19.99 SET OF 6 ★
1172539	8'	\$20.99 SET OF 6 ★
1172546	9'	\$21.99 SET OF 6 ★
1172553	10'	\$22.99 SET OF 6 ★
1172560	16'	\$33.99 SET OF 6 ★

LEATHER JUMP ROPE

- Ball bearing swivel and foam handles
- 9 1/2" long



2549XXXX	\$17.99 EA ★
----------	--------------

JUMP ROPE/HOOP RACK

- Stores and transports over 120 jump ropes (up to 10' long) plus hoops
- Large base for increased stability
- Bar heights of 56", 62" and 68" allow children and adults to easily access the correct size jump rope
- Easily goes through standard doorway



1188325	68"H x 27"L x 19"D	\$179.99 EA
---------	--------------------	-------------

JUMP ROPE TIP!

Use the following guidelines when selecting jump ropes for your students

- 6' - UP TO 4' 5" TALL
- 7' - 4' 5" TO 4' 10" TALL
- 8' - 4' 10" TO 5' 3" TALL
- 9' - 5' 4" TO 5' 10" TALL
- 10' - 5' 11" TALL AND OVER

NJ State Approved Co-op #65MCECSCPS Metropolitan/ Garden State Apparel Bid Term: 5/9/18 @ 5/8/20; Extended to 5/8/21



SPEED ROPES

- Poly rope with plastic swivel handle
- Speed, durability, and flexibility all in one rope

1040043	6'	\$2.49 EA ★
1040050	7'	\$2.69 EA ★
1040067	8'	\$2.89 EA ★
1040074	9'	\$2.99 EA ★
1040081	10'	\$3.19 EA ★
1040098	16'	\$4.09 EA ★



NEON SPEED ROPES

- Hot, bright, exciting neon colors
- Poly rope with plastic swivel handle is light, durable and flexible

1700XXXX	7' Pink	\$35.99 DZN ★
1702XXXX	8' Green	\$38.99 DZN ★
1701XXXX	9' Purple	\$40.99 DZN ★



LICORICE ROPES

- Perfect for beginners or experienced jumpers who want the best
- Great for speed jumping and a favorite with jump teams
- Injection molded handles designed for comfort and free spin
- Durable, plastic rope

17206XXX	Black 6' Licorice	\$3.79 EA
17207XXX	Orange 7' Licorice	\$3.99 EA
17208XXX	Red 8' Licorice	\$4.49 EA
17209XXX	Green 9' Licorice	\$4.99 EA
17210XXX	Black 10' Licorice	\$5.49 EA



WALL-MOUNTED JUMP ROPE RACK

- All steel wall-mounted unit features five 10" long pegs for storage
- 25" long unit attaches to wall to save space

MSWMJRACBM	\$44.99 EA ★
------------	--------------



SEGMENTED SKIP ROPES

- Designed for use by all age groups and skill levels
- An economical way to promote mass participation
- Great for a fun, aerobic workout
- Features durable, plastic segments over a solid long-lasting nylon cord

1040142	6' Black/White	\$2.29 EA ★
1040159	7' Red/White	\$2.39 EA ★
1040166	8' Blue/White	\$2.59 EA ★
1040173	9' Red/White/Blue	\$2.89 EA ★
1040128	10' Red/White	\$3.89 EA ★
1040180	11' Blue/White	\$4.19 EA ★
1040135	16' Green/White	\$5.19 EA ★



THE KANGA-ROPE™

BY HEARTBEAT

- Developers of Jump Aerobics™
- Tough colored plastic segments on solid braid cord with spin-free handles
- Choose any two-color combination from these colors: Black, Royal Blue, Green, Orange, Pink, Purple, Red, Yellow and White

1610XXXX	7'	\$78.99 DZN
1611XXXX	8'	\$84.99 DZN
1612XXXX	9'	\$90.99 DZN
1613XXXX	10'	\$98.99 DZN
1614XXXX	14'	\$85.99 SET OF 6
1615XXXX	16'	\$98.99 SET OF 6



DOUBLE-DUTCH JUMP ROPES

- Durable cotton/nylon blend ropes are designed for group jump rope activities

1706XXXX	14'	\$17.99 PR ★
----------	-----	--------------



TOURNAMENT BOCCE SET

- Indoor/outdoor bowling game promotes hand-eye coordination
- Solid, one-piece, composition resin, striped, precision balls
- Official ball of the United States Bocce Federation
- Features 8 bocce balls (107mm) and 1 jack ball (57mm)
- Includes rule book, instructions for court layout and zippered tote bag
- For all age groups

MSUS1602 **\$195.99** SET



GAMECRAFT® ECONOMY BOCCE SET

- Perfect for kids and beginner players
- Includes 8 synthetic 4" dia. balls (2 each Blue, Green, Purple, and Yellow) and 1 jack ball

7221XXXX **\$61.99** SET ★



PRO SHUFFLEBOARD SET

- Designed for heavy-duty outdoor use
- Cues have regulation 6' tempered aluminum shafts fastened to rugged plastic heads
- 6" high-impact, plastic discs for lively, non-flutter slide
- Set includes 4 cues, 8 discs and instructions

MSSHBSET Complete Set **\$269.99** SET
 MSSHBDIS 8 Replacement Discs **\$112.99** SET OF 8



ST. PIERRE® OFFICIAL HORSESHOES

- Official size and weight shoes - NHPA approved
- Includes four 2 lb. 8 oz. solid steel drop forged shoes, 2 solid steel 24"L regulation stakes and rules

3219XXXX **\$61.99** SET



RAMPSHOT

- Designed by a Physical Education teacher as an alternative to traditional tossing games, which only allow one player to be active at a time
- Three out of four player players are involved in every play in RampShot which allows for increased physical activity and player engagement
- A highly interactive game that develops motor skills, hand-eye coordination, teamwork and good old fashion fun
- Allows players to toss for points plus catch for points
- Ramps stack inside one another for easy storage and transportation

1388859 **\$70.99** EA



INDOOR/OUTDOOR HORSESHOE SET

- Includes four 9 oz. hard plastic shoes, two 12" rubber mats with two plastic 6" pegs for indoors and two 16" outdoor plastic stakes

MSSHOEIOY **\$30.99** SET ★



WASHER TOSS GAME

- Similar to horseshoes, players toss coated metal washers at the bulls eye target
- Score points for hitting the center bulls eye cup and for landing it in the box but not in the cup
- Portable game can be set up for different skill levels
- Includes 2 wooden boxes and 8 washers

1268874 **\$54.99** SET ★



DELUXE CROQUET SET

- Includes 6 solid wood mallets (24" x 7"), 6 color-coded knurled balls (2 3/4" dia.), 9 weather-resistant wickets, 2

1152043 **\$91.99** SET ★

Bid #ESCNJ 17/18-31

Educational Services Commission of New Jersey

Athletic Equipment & Supplies

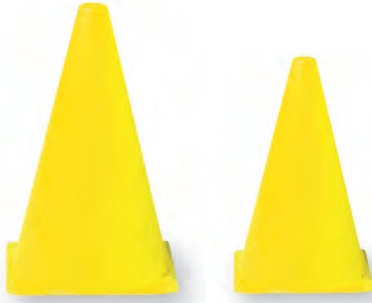

ECONOMY CONES

- Lightweight vinyl with small base
- No hole in top

MSCONE9XY	9"	\$3.09 EA ★
MS12CONEY	12"	\$4.09 EA ★



ORANGE GAME CONES

- Flexible PVC with weighted base for added stability
- Stack easily for storage

1040814	12"	\$9.19 EA ★
1040838	18"	\$11.29 EA ★
1040845	28"	\$30.99 EA
1040852SET	36"	\$214.99 SET OF 5



100' PENNANT STREAMERS

- Rope streamers with 18" nylon cloth pennants in a variety of colors: Blue, Green, Red, White and Yellow
- Use to dress up your field, crowd control or for cross-country events
- Sold in lengths of 100' (approx. 48 flags per 100')

1260XXXX	\$17.99 EA ★
----------	--------------

ROPE POSTS

- 5' galvanized steel post with pointed end for easy insertion into ground
- Minimum order of 6

1041392	\$42.99 EA
---------	------------



CONE CART

- Holds (60) 12" pvc or (200) plastic cones
- 1" diameter steel tube frame w/ silver powder coated finish
- 10" semi pneumatic wheels with roller bearings

1362619	45"H x 26"W x 16"D - 30 lbs.	\$152.99 EA ★
---------	------------------------------	---------------



NOW AVAILABLE IN 4 SIZES!

COLOR MY CLASS® GAME CONES

- Flexible, PVC cones with weighted bases for increased stability
- Use to designate boundaries, lanes and teams
- Each set includes 1 of each color: Blue, Green, Orange, Purple, Red and Yellow

1398265	28" Prism Pack	\$119.99 SET OF 6
1245875	18" Prism Pack	\$71.99 SET OF 6 ★
1093452	12" Prism Pack	\$44.99 SET OF 6 ★
MS6CONPK	6" Prism Pack	\$29.99 SET OF 6 ★



LOW PROFILE CONES

- Soft, flexible and stack easily
- Color code your drills for more effective practice time
- Available in Orange, Yellow or Prism Packs (2 each: Blue, Green, Orange, Purple, Red and Yellow)
- 3"H x 7 3/4" diameter

1255706	Orange	\$13.29 DZN ★
1276558	Yellow	\$13.29 DZN ★
1255690	Prism Pack	\$13.29 DZN ★



COLOR MY CLASS® SPOT MARKERS

- 9" diameter, soft, flexible, plastic markers
- Stick to gym floors without shifting
- Prism packs: include either 1 or 2 of each color: Blue, Green, Orange, Purple, Red and Yellow

6058SPOT	Prism Pack	\$30.99 DZN ★
1309973	Prism Pack	\$16.99 SET OF 6 ★
80598XX	Orange	\$6.99 DZN ★



Pickleball. Great for All Ages!



3.0 TOURNAMENT NET & FRAME

- Portable, regulation-size pickleball 3.0 Tournament Net
- Comes with a high-strength 22' steel snap-together frame, lightweight net and instructions on how to set-up and play, all in a sturdy carry bag

90 Day Limited Warranty

1450232

\$199⁹⁹ EA



3.0 TOURNAMENT NET & FRAME SET WITH DILLER WOOD PADDLES

- This tournament set includes everything you need to get started playing pickleball
- Includes portable, regulation-size metal frame, net, 4 Diller paddles, 4 pickleballs, nylon carrying bag and rules/strategy guide

90 Day Limited Warranty

1364661

\$269⁹⁹ SET



3.0 TOURNAMENT NET & FRAME SET WITH CHAMPION LT COMPOSITE PADDLES

- A complete package for the performance-minded pickleball player
- Includes portable, regulation-size metal frame, net, 4 durable and lightweight composite Champion LT paddles, 4 pickleballs, nylon carrying bag and rules/strategy guide

90 Day Limited Warranty

CHAMPION LT PADDLE

- Take your game to the next level with these lightweight and durable performance paddles
- Features strong polypropylene honeycomb core, composite facing and a proprietary one-piece edge guard

1450228

\$49⁹⁹ EA

CHAMPION PADDLE

- A great choice for recreational and advanced competitive players
- Great ball feel, touch and power in a lightweight paddle
- Features Nomex composite honeycomb core and graphite face with skin-feel performance grip

Color Options: **Blue, Red.**

1384931

Specify Blue or Red \$84⁹⁹ EA

PICKLEBALLS

- Designed for durability and performance
- Seamless, molded plastic ball
- Also great for baseball and softball drills
- Dura Fast 40 = Outdoor
- Jugs Poly Bulldog = Indoor

Color Options: **Neon, Orange, White, Yellow.**

1050XXXX Outdoor - Specify Color \$39⁹⁹ DZN

1384886 Indoor - Yellow \$19⁹⁹ DZN

DILLER PADDLE

- Lightweight 7-ply maple wood paddle with wrapped handle and safety wrist strap
- From the company that invented the game
- A top choice for recreational and institutional play

1450225

\$16⁹⁹ EA



DILLER PADDLE & BALL PACK

- The Ultimate Starter Kits!
- Durable maple wood pickleball paddles with wrapped grip, safety strap and pickleballs

1450226 2 Paddles + 4 Balls \$29⁹⁹ PACK

1450227 4 Paddles + 4 Balls \$49⁹⁹ PACK



CHAMPION LT PADDLE & BALL PACK

- A great value to get your pickleball game going
- Champion LT performance composite pickleball paddles and pickleballs

1450229 2 Paddles + 4 Balls \$97⁹⁹ PACK

1450230 4 Paddles + 6 Balls \$189⁹⁹ PACK



DILLER NET SET

- A complete pickleball set for those who have existing net stanchions
- Includes a durable tie-on net (22'L), 4 Diller paddles, 4 pickleballs and a rules/strategy sheet

1024XXXX

\$214⁹⁹ SET



PICKLEBALL INC.



MORE PICKLEBALL ITEMS AVAILABLE IN OUR RACQUET SPORTS SECTION

EQUIPMENT



THE RECRUIT STARTER SET

- Perfect for those pickleball players eager to get out on the court and learn the sport
- Kit includes: 2 hardwood paddles and 2 pickleballs

1393481 \$40⁹⁹ SET



THE RECRUIT 1.0 PADDLE

- A recreational, 6-ply bass wood pickleball paddle that features a stained-wood handle
- Perfect for the beginner player looking for a solid-feeling pickleball paddle

1393482 \$22⁹⁹ EA



THE RECRUIT 2.0 PADDLE

- A recreational, 7-ply baltic birch wood pickleball paddle that features a padded grip on the handle
- Provides a solid feel and long-lasting durability for entry-level players

1393483 \$30⁹⁹ EA



THE COMPOSITE STRYKER

- Perfect for players looking to trade up from a wood paddle to a composite
- Offers the lightweight playability of a nomex core with the power of a fiberglass face

1393484 \$81⁹⁹ EA



THE GRAPHITE Z5

- The top selling paddle in the Onix line
- Offers the premium, lightweight playability of a graphite face and increased control of a nomex core

1393485 \$97⁹⁹ EA

NET



PORTABLE PICKLEBALL NET

- 34" H x 22" W
- Meets USAPA requirements
- Premium carry bag with wheels for easy transportation
- Quick assembly

1393490 \$193⁹⁹ EA

BALLS



OUTDOOR BALLS

- 6 outdoor Yellow balls

1393486 Yellow \$17⁹⁹ PACK OF 6

1393487 Orange \$17⁹⁹ PACK OF 6



INDOOR BALLS

- 6 indoor Yellow balls

1393488 Yellow \$17⁹⁹ PACK OF 6

1393489 Orange \$17⁹⁹ PACK OF 6

FEATURES & SPECS	ONIX PURE™ OUTDOOR BALL	ONIX PURE™ BALL
Recommended for outdoor play	x	In low wind conditions
Recommended for indoor play		x
Pure Bounce Technology	x	x
True Flight Technology	x	x
Weather Weighted	x	
More accuracy, control, and consistency	x	x
Smaller hole design for better flight in outdoor conditions	x	
Meets USAPA requirements	x	x



DISC GOLF DISCATCHER®

- Galvanized steel construction with HD welds
- 28 chain grid design
- Powder coated stainless steel chain rack with vinyl numbers
- Anti-skip basket rim prevents skips
- PDGA approved

MDCI	In-Ground/Permanent	\$612 ⁹⁹ EA
MDCP	Portable w/Base	\$612 ⁹⁹ EA

PORTABLE ECONOMY DISCATCHER®

- Same specs as above units except 18 single chain design with electroplate galvanized finish
- Portable model that can be locked down
- Not meant for permanent outdoor installation

20029345		\$269 ⁹⁹ EA
----------	--	------------------------



MACH LITE PORTABLE PRACTICE TARGET

- Lightweight (26 lbs.), portable and compact with folding upper chain assembly, basket assembly and base
 - Sturdy steel frame with 16 heavy-duty chains
 - PDGA approved
 - Not designed to be left outdoors
 - Includes carry bag and game instructions
- Color Options: **Black, Blue.**

1390389	Specify Color	\$193 ⁹⁹ EA
---------	---------------	------------------------



DISC GOLF SCHOOL PACK

- Includes 12 each drivers, mid-range and putters
- Store in the mesh bag included

1304176		\$203 ⁹⁹ SET OF 36
---------	--	-------------------------------



TRAVELERS DISCATCHER® TARGET

- Lightweight, portable target pops open in seconds
- Chain and mesh fabric catching area
- Features a wide sturdy base, anchor rings and stakes for increased stability
- Includes bag for storing and transporting
- 50"H x 22"W x 22"L (colors may vary)



1246056	Single Target	\$173 ⁹⁹ EA
1246063	9 Target Course	\$1,359 ⁹⁹ SET OF 9



COMPETITION DISCS

- Top of the line flying discs for sports games
- Available in 3 different weights, each offering individual features for distance, loft, and freestyle throwing

MSDIS120Y	120g Neon Pink	\$7 ¹⁹ EA ★
MSDIS140Y	140g Neon Orange	\$7 ⁶⁹ EA ★
MSDIS165Y	165g Neon Yellow	\$8 ¹⁹ EA ★



PLASTIC FLYING DISCS

- More fun for the money than any other game
- Each set includes 1 of each color: Blue, Green, Orange, Purple, Red and Yellow

1201550	9" Diameter	\$14 ²⁹ SET OF 6 ★
---------	-------------	-------------------------------



ULTIMATE FRISBEE® DISC

- Meets the specifications for the sport of Ultimate
- UPA approved - 175 grams and 10 1/2" diameter
- Colors and graphics may vary

1268942		\$13 ⁹⁹ EA
---------	--	-----------------------



DISC GOLF PACK

- Includes everything you need to get started
- Durable plastic construction
- Includes: 8 each fairway driver, mid-range and putter
- Age appropriate weights will be shipped

1399737	Elementary Age Pack	\$219 ⁹⁹ PACK
1399738	Middle School Age Pack	\$219 ⁹⁹ PACK

Bid #ESCNJ 17/18-31

Educational Services Commission of New Jersey

Athletic Equipment & Supplies



BAGGO BEAN BAG TOSS GAME

- Played similar to horseshoes
- Weighs only 20 lbs. and folds making it easy to carry and store (2 1/2"H x 20"W x 36"L)
- Constructed of high-impact polyethylene for lasting durability
- Take the two boards, spread them apart and begin to play
- Includes 2 game boards, eight 6" bean bags, a distance regulator, wall mounting bracket, and instruction booklet

1269000		\$122 ⁹⁹	SET
1269017	Replacement Bean Bags - 4 Red + 4 Blue	\$28 ⁹⁹	SET OF 8



5" NYLON BEAN BAGS

- Nylon bags are filled with synthetic filler
- Please specify one color per dozen or purchase a prism pack which includes 2 of each color
- Color Options: **Blue, Green, Orange, Purple, Red, Yellow.**

1039900	Specify Color	\$16 ⁹⁹	DZN ★
1293418	Prism Pack	\$16 ⁹⁹	DZN ★

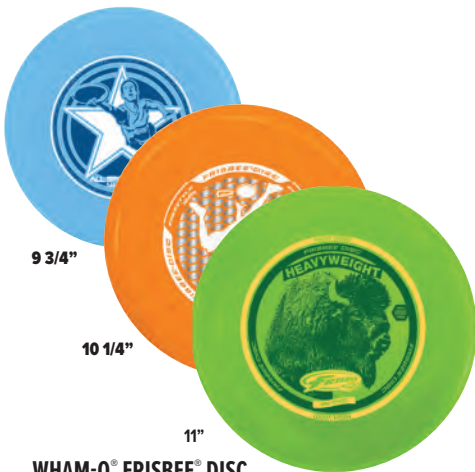

WHAM-O® FRISBEE® DISC

- The original Frisbee®
- 3 weights and diameters to choose from
- Colors and graphics may vary

1308815	9 3/4" Diameter - 140 Grams	\$8 ⁹⁹	EA
1308822	10 1/4" Diameter - 180 Grams	\$9 ⁹⁹	EA
1308839	11" Diameter - 200 Grams	\$13 ⁹⁹	EA



FOAM HOOP HOLDERS

- Create your own games by sliding hoops or wands on horizontally and vertically
- Create dozens of over, under and through obstacles
- Use with our standard, deluxe and premium hoops
- Each set includes 1 pair of each color: **Blue, Green, Orange, Purple, Red and Yellow**

1812XXXX \$40⁹⁹ SET OF 6 PAIR



SAFETY GUARD SCOOTERS

- AVAILABLE IN 6 COLORS!
- 12" x 12" x 1" thick heavy-duty plastic boards
- Feature safety hand guards with non-marring, double ball-bearing swivel casters
- Color Options: **Blue, Green, Orange, Purple, Red, Yellow.**

6CSC12	Specify Color	\$23 ⁴⁹	EA ★
1092493	Prism Pack	\$132 ⁹⁹	PACK OF 6 ★
1389167	Replacement Wheels	\$7 ¹⁹	SET OF 4 ★



ZOOMER SCOOTERZ

- 16" x 16" scooters with safety guards to protect hands and fingers
- Feature large 4", durable all-terrain, ball bearing wheels
- Tough enough for the playground but will not harm gym floors
- Each set includes 1 of each color: **Blue, Green, Orange, Purple, Red and Yellow**

1265293	Prism Pack	\$336 ⁹⁹	SET OF 6 ★
1295682	Replacement Wheels	\$26 ⁹⁹	SET OF 4 ★
1389168			



STANDARD HOOPS

- No P.E. or recreation program is complete without hoops
- Versatile hoops teach balance, coordination and rhythm
- Use as targets, jump and hop rings for races and much more
- Each dozen includes 2 of each color: **Blue, Green, Orange, Purple, Red and Yellow**

1246087	24" Diameter	\$39 ⁹⁹	DZN
1246070	30" Diameter	\$43 ⁹⁹	DZN
1274646	36" Diameter	\$47 ⁹⁹	DZN

DELUXE HOOPS

- Stronger than our standard hoops - thicker wall
- Set them up as targets for tossing, jump and hop rings for races or in your obstacle course
- Set of 12 includes 2 of each color: **Blue, Green, Orange, Purple, Red and Yellow**

1064902	24" Diameter	\$59 ⁹⁹	DZN
1064919	30" Diameter	\$64 ⁹⁹	DZN
1064926	36" Diameter	\$69 ⁹⁹	DZN



PREMIUM NO-KINK® HOOPS

- Regular hoops often become the object of tug-of-war
- Pulling causes a kink, and off to the hoop graveyard!
- Extra thick walls prevent kinking
- Includes 2 of each color: **Blue, Green, Orange, Purple, Red and Yellow**

02150XXX	24" Diameter	\$61 ⁹⁹	DZN
021718X	30" Diameter	\$66 ⁹⁹	DZN
02170XX	36" Diameter	\$70 ⁹⁹	DZN



YOUTH LACROSSE STICK

- Aluminum shaft, wide plastic head with nylon mesh pocket
- 40" overall length makes this the ideal stick for the beginner or youth player

Color Options: **Blue, Red.**

1363676 Specify Color **\$19⁹⁹** EA ★



TRAINING SET

- Play indoors or out with a safer, modern stick
- Sticks feature plastic pockets and exclusive ball "keeper" straps
- Sticks are lightweight, flexible, durable and will not harm gym floors
- Includes: (12) 36" sticks, 6 orange balls, rule book and lesson plans

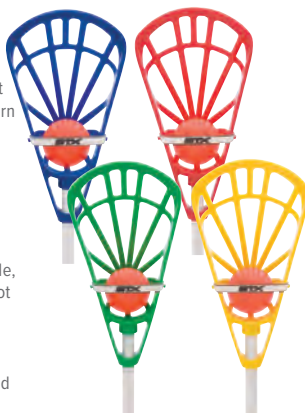

1010XXXX	Blue & Red Set	\$254⁹⁹ SET
1011XXXX	Yellow & Green Set	\$254⁹⁹ SET
1012XXXX	Sticks Only - Specify 1 Color	\$132⁹⁹ SET OF 6



FUN-AIR SCOOP BALL

- Helps to develop hand-eye coordination
- Use as a lead-up to lacrosse activities
- Complete set of two throwing scoops and a soft ball sized fun ball

1040104	Green and Pink	\$10⁹⁹ SET ★
1270402	Prism Pack	\$50⁹⁹ SET OF 6 ★



POLYBAT

- 29 1/2" long bat weighs 7 oz. - hollow with taped grip

MSC05705 **\$8⁹⁹** EA ★



PLASTIC TRAINING BALLS

- Designed for true slow and limited flight

1033601	9" Baseball	\$9⁹⁹ SET OF 6 ★
1033618	12" Softball	\$9⁹⁹ SET OF 6 ★
1141245	Wiffle® 9" Baseball	\$1⁹⁹ EA
3193XXXX	32" Wiffle® Bat	\$4⁹⁹ EA



DEBEER CLINCHER® SOFTBALL

- Trutech leather cover
- Kapok core
- Unique Clincher® hidden stitching
- Great for use on hard surfaces

30 Day Limited Warranty

1388860	12"	\$129⁹⁹ DZN
1388861	16"	\$219⁹⁹ DZN



Voit

SPONGE CENTER SOFTBALL

- Very soft rubber cover
- Cotton surface windings

VSBC8125 12" White **\$5⁹⁹** EA ★



SPIKEBALL

- A fun, aerobic game that is played 2 on 2
- It's sort of a funky combo of four square and volleyball
- A taut hoop-sized net is placed at ankle level between a pair of two-player teams
- You smack the palm-sized ball down on the net so it ricochets up at your opponents
- They have up to three hits between them (just like volleyball) to control it and bounce it back to you
- When they miss, you score
- Includes 1 net and frame with 3 balls

90 Day Limited Warranty

1376884	Combo Set	\$59⁹⁹ SET
1376885	2 Replacement Balls	\$8⁹⁹ SET

Bid #ESCNJ 17/18-31

Educational Services Commission of New Jersey

Athletic Equipment & Supplies



Voit
TETHERBALLS

- Both balls feature nylon windings and a butyl bladder for added shape and air retention
- Choose between a soft touch cover for added comfort or a traditional rubber cover
- Includes an attached recessed rope

- 1. **VCT850HS** Soft Touch Cover \$18⁹⁹ EA ★
- 2. **VCT850HX** Rubber Cover \$16⁹⁹ EA ★



SSTB SOF-T™ TETHERBALL

- Manufactured with a special rubber composition cover
- Provides a softer play and feel
- Includes a nylon rope with metal clip

- 3. **TACSSTBX** \$20⁹⁹ EA



PORTABLE TETHERBALL STANDARD

- 40" dia. steel base with a non-marring rubber edge
- Rolls indoors or outdoors
- 10'H pole is 1.9" OD galvanized steel tube with a permanent top eye
- Ball included

- THBPORT** \$439⁹⁹ EA ★

OUTDOOR TETHERBALL POLE

- 12'L (2 pieces 6'L) 2 3/8" galvanized steel post installs permanently into the ground 2'
- Permanent top eye and ball included

- THBIG** \$159⁹⁹ EA ★

TETHERBALL POLE GROUND SLEEVE

- For semi permanent installation of our outdoor pole

- STTBGSXX** \$45⁹⁹ EA ★



RUBBER BUCKET SWING CHAIR

- Soft, all-weather safety seat for toddlers
- Safety chain included
- For ages 2-4

- 1040746** \$61⁹⁹ EA ★

360° ENCLOSED SWING SEAT

- Heavy-duty, rubber enclosed seat for infants
- For ages 2-4

- 1040685** \$91⁹⁹ EA ★



6" SLASH-PROOF SWING SEAT

- Synthetic rubber seat with a metal insert for increased durability
- For ages 5-12

- 6152DXXX** \$30⁹⁹ EA ★

REPLACEMENT SWING SET PARTS

- 1041217** 3/8" Galvanized Large S-Hook \$2⁹⁹ EA ★
- 1041354** 4/0 Heavy Duty Galvanized Chain (Specify Length) \$5⁹⁹ FT ★



JUGGLING SCARVES

- Teach juggling fundamentals with these 15" square, nylon scarves
- Beginners enjoy early success with these scarves that float through air
- Engages children with poor concentration
- Includes 2 of each color: Blue, Green, Orange, Purple, Red and Yellow

- 1206258** \$9⁹⁹ PACK OF 108 ★
- 1041057**

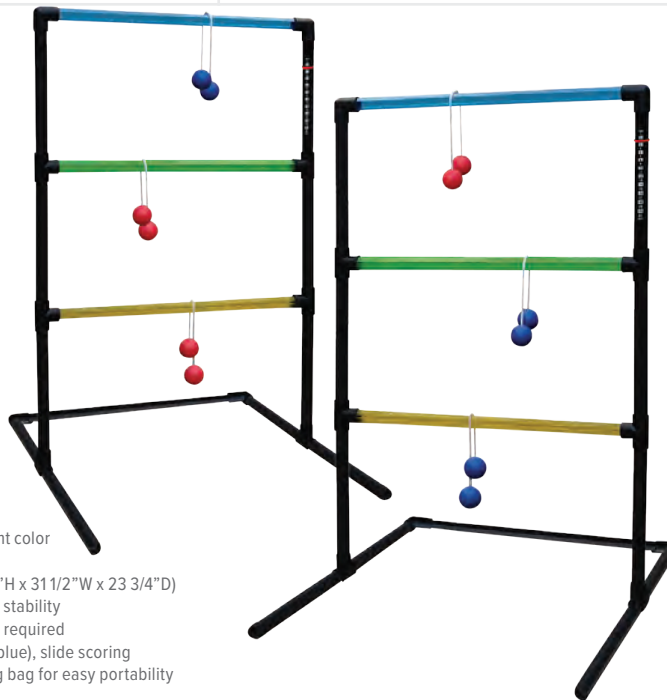

LADDER TOSS GAME

- Toss the bolos onto the different color rungs to score points
- Features 2 PVC ladders (36 1/4"H x 31 1/2"W x 23 3/4"D) with weighted bases for added stability
- Ladders set up easily - no tools required
- 6 semi-firm bolos (3 red and 3 blue), slide scoring system on ladders and carrying bag for easy portability included

- 1396065** \$41⁹⁹ SET

NJ State Approved Bid Term: 5/9/18 - 5/8/20: Extended to 5/8/21

PHYSICAL EDUCATION



FOLDING SPORTS GOAL

- High impact, 1 5/8" PVC tubing with center pipe support for added strength
- Features a "sleeve" netting system that slides on easily
- Quick and easy assembly - folds for storage
- 44"H x 54"W x 24"D

1065336 \$50⁹⁹ EA
 1304855 \$26⁹⁹ EA Replacement Net



FOLDING ALL PURPOSE GOAL

- 1 5/8" high-impact PVC frame
- Push-button Loc fittings for easy folding and storage
- Bungee Slip-Net with 1-1/2" mesh size for quick set-up
- Double back support bars for stability
- Includes ground anchors for outdoor use
- 48"H x 72"W x 36"D

1304763 \$91⁹⁹ EA
 1304794 \$25⁹⁹ EA Replacement Net



ALL PURPOSE STEEL GOAL

- Heavy gauge 1 1/4" steel tubing with center pipe support
- Features the sleeve netting system
- Pro style design with top shelf
- Assembly required - non folding
- 43"H x 52"W x 28"D

1256208 \$64⁹⁹ EA
 1304855 \$26⁹⁹ EA Replacement Net



ULTRA PRO GOAL

- 1 5/8" PVC tubing with back support bar
- Includes heavy-duty sleeve net
- Pro style design - assembly required
- 44"H x 54"W x 24"D

1304848 \$74⁹⁹ EA
 1304855 \$26⁹⁹ EA Replacement Net



FOLDING STEEL HOCKEY GOAL

- Durable, 1 1/2" diameter, 18 gauge, steel frame
- Bungee slip net with clamps for easy attachment and adjustment
- Includes anchors for outdoor use on grass
- 44"H x 54"W x 30" D

1343113 \$101⁹⁹ EA
 1388262 \$20⁹⁹ EA Replacement Net



MULTI-PURPOSE EQUIPMENT CART

- Constructed of 1" powder coated steel tubing
- Great for carrying PE and baseball equipment
- Polyester bag measures 24"H x 24"W x 12"D

1197655 \$204⁹⁹ EA ★
 46"H x 29"W x 30"D - 29 lbs.

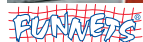

SOCCER/HOCKEY GOAL - ABS

- 4' x 6' goal to be used indoors or outdoors for soccer, hockey, floor hockey or many other uses.
- 3mm net with nylon sleeves
- 1 5/8" O.D. Sportstuff rods and assembled with ABS fittings
- Weight: 18 lbs.

FH046D \$183⁹⁹ EA ★
 1162400 \$65⁹⁹ EA Replacement Net



SOCCER/HOCKEY GOAL - STEEL

- 4' x 6' goal to be used indoors or outdoors for soccer, hockey, floor hockey or many other uses
- 3mm net with nylon sleeves
- 1 5/16" O.D. galvanized steel tubing and assembled with galvanized steel fittings; equipped rubber footings for indoor use
- Weight: 44 lbs.

FH046S \$183⁹⁹ EA ★
 1162400 \$65⁹⁹ EA Replacement Net

ORIGINAL PILLO POLO® GAME

HOW THE GAME IS PLAYED:

- Played similar to ice hockey rules, except the goalie is allowed to pick up the ball and throw it down field
- No. Players: 12 plus substitutes
- Age Levels: 7 years and up
- Space Required: 50' x 100'
- Supervision Required: 1 Referee
- Average Activity Time: 30 - 60 min.
- Sticks are lightweight yet durable - tough outer skin over urethane foam heads that resist peeling and flexible plastic shafts

HIGH PERFORMANCE STICKS. MADE OF SOFT DURABLE FOAM!



COMPLETE PILLO POLO® GAME

- 6 Blue and 6 Yellow sticks 31" long, two 7" foam balls, set of official rules
- Goals, cones and bag not included

1041170

\$152⁹⁹ SET ★

DOUBLE PILLO POLO® GAME

- 12 Blue and 12 Yellow sticks 31" long, four 7" foam balls, set of official rules
- Goals, cones and bag not included

2600XXX

\$275⁹⁹ PACK ★



ACCESSORIES

EXTRA PILLO POLO® STICKS

Specify Blue or Yellow

601XXXX

\$16⁹⁹ EA ★

6" GAME CONES

Color Options: Blue, Orange, Purple, Red, Yellow, Green.

MSCONE

\$29⁹⁹ EA ★

STORAGE BAG

Color Options: Black, Blue, Gold, Kelly, Orange, Purple, Red.

SNBCNET

\$11⁹⁹ EA ★

EXTRA 7" FOAM BALLS

607XXXXY

\$10⁹⁹ EA ★

PILLO POLO GOAL

• 44"H x 54"W x 30"D steel goal

1343113

\$101⁹⁹ EA



PILLO POLO® STARTER PACK

With substitutions every 5 minutes, this exciting fast-paced game can keep 24 boys and girls constantly moving. Plus you may use your goals, nets and game cones for other activities.

Package includes:

- 1 complete Pillo Polo® Game
- 1 set of official rules
- 1 pair of goals
- 6 cones (6")
- 1 mesh storage bag

999913

22 Pieces

\$379⁹⁹ SET ★



PILLO HOCKEY

- Combines floor hockey, polo, field hockey and ice hockey in one safe, soft and easy-to-use game
- Perfect for all ages
- The head is made of soft urethane foam attached to a flexible, hollow, plastic stick with a contoured handle
- Set includes: 5 Blue and 5 Yellow 36"L sticks, 1- 7" foam ball, and 1- 4" puck

625XXXX

Complete Set

\$153⁹⁹ SET ★

607XXXXY

7" Vinyl Coated Foam Ball

\$10⁹⁹ EA ★



TOPPLEBALL®

- Requires only a 60' square area to play
- Played in over 10,000 recreation and school systems
- Permits 15-25 players to participate and be involved
- Easy to learn - play indoors or out - for ages 8 and up
- **How The Game is Played:**

- Players form a circle and each takes a turn batting
- Batter with the most runs wins game

- **Batter's Objective:** Get the maximum number of runs before the "Toppleball" is knocked off the batter's post by the playground ball - batter hits the playground ball past the fielders and runs to the edge of the circle and back earning a run

- **Fielder's Objective:** Get the batter out by knocking the "Toppleball" off the post with the playground ball - requires teamwork

1125924

NJ State Approved Co-op #65MCESCCPS - Metuchen/Garden State AppareBid Term: 5/9/18 - 5/8/20: Extended to 5/8/21

1125931

Replacement Bat

\$40⁹⁹ EA ★





ETHAFOAM TARGETS WITH REPLACEABLE CORE

- Used at many of the finest camp and school archery programs
- Features an 18" replaceable core
- 6" thick foam is weather/insect proof with self healing tendency
- Target stand sold separately
- Target face included

1375654	36" Square	\$193 ⁹⁹ EA ★
1375655	36" Round	\$193 ⁹⁹ EA ★
1375656	48" Square	\$275 ⁹⁹ EA ★
1375657	48" Round	\$275 ⁹⁹ EA ★
ARCORE	18" Replacement Cores - Fits 36" and 48"	\$209 ⁹⁹ SET OF 3 ★



E-Z TARGET

- Finally a good quality, economical foam target for institutional use
- 36" square and 3 1/2" thick
- Comes complete with stand and paper target face
- Lightweight for easy set up and take down
- For bows up to 40 lbs.

30 Day Limited Warranty

1308563

\$69⁹⁹ EA



POWERLIGHT TARGET

- High density foam for maximum durability
- Twice the life of normal recreational targets
- Accepts up to 70 lb. draw weight bows
- Easy arrow removal
- Target face included

1394269	36" - 35 lbs.	\$234 ⁹⁹ EA
1394270	48" - 50 lbs.	\$306 ⁹⁹ EA



CAN BE USED WITH BOWS UP TO 70LBS.

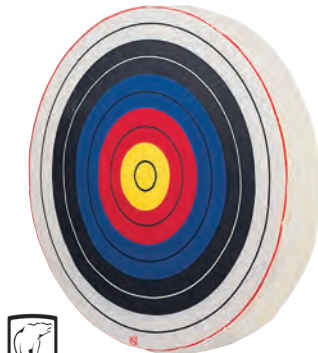

FOAM TARGETS

- 100% self-healing foam - 6" thick
- Waterproof, UV resistant and impervious to insects
- Reversible - adds life to your target
- Target face included

3739XXXX	36" - 12 lbs.	\$279 ⁴⁹ EA
3740XXXX	48" - 18 lbs.	\$369 ⁹⁹ EA

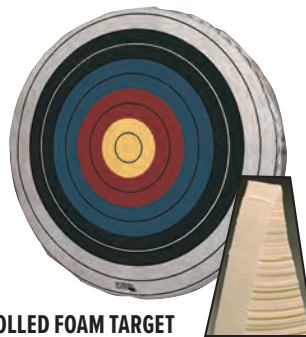

ROLLED FOAM TARGET

- Lighter weight for easy set up and storage
- Features "Rolled Heat Bond" - foam strips laminated under heat and pressure
- Arrows cause much less permanent damage
- Available in 36" and 48" diameters
- Approximately 7" thick
- Target face included

NECA236X	36" - 15 lbs.	\$209 ⁹⁹ EA
NECA248X	48" - 30 lbs.	\$309 ⁹⁹ EA

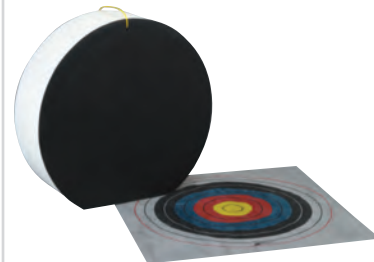

FREE STANDING ROLLED FOAM TARGET

- Features "Rolled Heat Bond" - foam strips laminated under heat and pressure
- No stand needed because bottom is flat
- 36" tall and 12" thick
- Built-in carry handle
- 4 color hang on face included

NECA536	36" - 30 lbs.	\$249 ⁹⁹ EA
---------	---------------	------------------------



TARGET STANDS

- Holds 36" and 48" targets

3718XXXX	Wheeled Stand	\$50 ⁹⁹ EA ★
1197761	Tripod Stand	\$50 ⁹⁹ EA ★



MONSTER TARGET STAND

- Adjustable - holds all targets 30" - 50" in diameter
- Constructed using 1 1/3" galvanized steel tubing
- Large wheels allow for easy rolling

ARTARSTD		\$179 ⁹⁹ EA ★
----------	--	--------------------------

ARCHERS' FAVORITE FIBERCLOTH FACES



ROUND TARGET FACES

- Long lasting, fibercloth material
- Waterproof - skirted

1282566	48" - Slip-On	\$29 ⁹⁹ EA ★
1282580	36" - Slip-On	\$19 ⁹⁹ EA ★

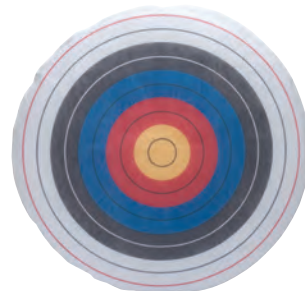

SQUARE TARGET FACES

- Long lasting, fibercloth material
- Waterproof - no skirt

1282573	48" - Flat	\$26 ⁹⁹ EA ★
1282597	36" - Flat	\$17 ⁹⁹ EA ★



Bid #ESCNJ 17/18-31

Educational Services Commission of New Jersey

Athletic Equipment & Supplies

Abdominal Exerciser 243
 Abwheel 256
 Accelerometers 273
 ADA Bleachers 11-12
 Adjustable Basketball Systems 98, 100-101
 Adjustable/Portable
 Basketball Standards 98, 100-101
 Advantage Court Repair 188
 Aerobic Steps 264
 Agility Ladder/Trainers 124, 269
 Air Hockey Tables/Accessories 306
 Air Horn 290
 Aluminum Channeling 338-339
 Ankle Braces 328
 Archery 358
Assessment 271-277
 Blood Pressure Monitors 275
 Body Fat Measurement 275-276
 Flex Testers 274
 Heart Rate Monitors 271, 275
 Jump & Reach Boards 274
 Pedometers & Accelerometers 272-273
 Pulse Oximeters 276
 Scales 275-277

Back & Abdominal Exercise Bench 243
 Backboard Padding 107
 Backboards, Basketball 102-103
 Backgammon 308
Backpacks
 Baseball 68-69
 Badminton 194-195
 Baggo Toss Game 353
 Balance Disc 258
 Ball Baskets 189
 Ball Carriers/Lockers 114, 334-337
 Ball Hoppers 189
 Ball Racks 114, 334-337

Balls
 Baseballs 56-59, 64-66
 Baseballs - Flat Seam 56
 Basketballs 93-97, 341-342
 Bocce Balls 348
 Bowling 346
 Cageballs 344
 Dodgeballs 345
 Field Hockey Balls 160
 Foam Balls 344-345
 Footballs 118-120, 341-344
 Four Square 342
 Futsal 164-165
 Handballs 194
 Have a Ball Value Pack 341
 Heavy Basketballs 97, 113
 Incrediballs 64
 Jelly Ball 344
 Kickballs 342
 Kin-Ball 342

Lacrosse Balls 159
 Medicine Balls 253
 Omnikin Balls 344
 Pickle Balls 350-351
 Ping Pong 302
 Pitching Machine Balls 55
 Playground Balls 343
 Racquetballs 197
 Reaction Ball 268
 Rubber Sport Balls 341-342
 Six Color Packs 341
 Soccer Balls 162-164, 341-342
 Softballs 60-66
 Special Tuff Balls 345
 Squash 196
 Stability Balls 258-259
 Table Tennis 302
 Tee Balls 59, 64-65
 Tennis Balls 192
 Tennis Trainers 192
 Tetherball 355
 Total Control Balls 65
 Training Balls 341-345, 354
 Unbelievaball 64
 Utility Balls 342
 Value Packs 341
 Volleyballs 216-219, 342
 Wallyball 226
 Wiffle Balls 65, 354
 Z-Balls 268

Bar Lifter 203
 Bar Wrap Pads 234
 Barbells 234

Baseball 16-83
 Accubat 79
 Backpacks 68-69
 Backstops & Padding 16-19, 24-25
 Ball Bags, Umpire 75
 Ball Baskets 66
 Ball Bucket 66
 Base Caddy 47
 Base Plugs 48-50
 Baseball Caps 86-87, 90-91
 Baseball Foul Poles 28, 32
 Baseball Jerseys 84-86, 89
 Baseball Pants 88-89
 Baseball/Softball Belts 88
 Baseballs 56-59, 64-66
 Baseballs - Flat Seam 56
 Bases 47-51
 Bat Bag 68-69
 Bat Rack 83
 Bat, Stick Training Bat 79
 Batters Box Foundations 38-39
 Batters Box Template 45
 Batting Cages & Accessories 16-19
 Batting Helmets 70-71
 Batting Practice Tuff Blanket 34-35

Batting Tees 67
 Batting Tunnels 20
 Batting Tunnels - Netting 21, 29
 Big Bubba Pro Batting Cage 19
 Bubba Elite Batting Cage 16-17
 Catcher's Equipment Bag 68-69
 Catcher's Helmets/Gear 72-74
 Catcher's Mitts 76-78
 Catching Mat 37
 Clay, Baseball/Softball Field 39
 Double First Bases 47-51
 Drag Mats 40-41
 Dry Line Markers 45, 297
 Dugout Organizer Rack 83
 Fence Guard 25
 Fence Stakes 30-31
 Fencing 30-32
 Fencing, Smart Poles 30-31
 Field Conditioners 39
 Field Covers/Tarps 33-35
 Field Groomer 40-41
 Field Markers/Stripers 45, 296-297
 Field Marking Paint 45, 296-297
 Field Marking Stick 45, 297
 Field Marking Systems 294-295
 Field Tarp Roller 33
 Foul Ball Return Station 83
 Glovers Binder 83
 Gloves 76-78
 Grass Protectors 34-35
 Ground Anchors, Baseball 48, 50-51
 Ground Stakes, Baseball 30-31
 Helmet Caddy 83
 Hit-A-Way 79
 Hitting Mats, Baseball/Softball 37
 Hitting Nets 81
 Hitting Trainer 79
 Home Plates 46, 48, 50-51
 Hoses 44
 Incrediballs 64
 Instructo-Swing 79
 Jox Box 38
 Lightning/Storm Detector 54
 Line-Up Cards 83
 Line-Up/Field Boards 82
 Loop Hoe Edger 43
 Marking Dust 39
 Mops, Infield Finishing 42
 Mound & Base Covers 33-35
 Mound Slope Gauge 43
 Net Saver 21
 Netting 21, 29
 Nozzles 44
 On-Deck Circle 37
 Overseed Enhancing Tool 43
 Paint, Field Marking 45, 297
 Pitch Counter 54
 Pitch Indicator 54

Pitcher Practice Screen 22-23, 81
 Pitchers Mounds 52-53
 Pitchers Plate 46
 Pitchers Rubbers 46, 50-51
 Pitchers Training Plates 48, 77
 Pitching Machines 55
 Pitching Machine Balls 65
 Pitching Mat, Softball 52
 Pitching Mounds 52-53
 Pitching Target 80-81
 Plate Brush 75
 Playback Trainer 80-81
 Poly Cap 25
 Pop Up Nets 81
 Portable Backstops 24
 Portable Pitching Screen/Nets 22-23, 80-81
 Protective Screens/
 Baseball & Softball 22-23, 80-82
 Protector Nets 21-23, 29
 Radar Guns 54
 Rakes 43
 Ricochet Cushion 18, 25
 Rosin Bags 54
 Safeoam Padding 18
 Scoreboards 316-327
 Screens, Ball Park 22-24, 81-82
 Shovels 43
 Slide Rite 79
 Smart Pole Fencing 30-31
 Softball Defensive Facemask 74
 Softball Helmets 70-71
 Softballs 60-64
 Softhands Infield Trainer 78
 Speed Gun 54
 Sportpanel Fencing 32
 Step-Down Rubbers 46-50
 Stride Guide 52
 Strike Zone Home Plate 80
 Striker II Hitting Trainer 79
 String Winder 39
 Tally Counter 54, 82
 Tamp 42
 Tarp Cart 34
 Template, Batters Box 45
 Throat Protectors 72
 Throwdown Bases 48
 Total Control Balls 65
 Training Bats 79
 Turf 36
 Twine 29, 39
 Ultimate Pitching Machine 39
 Umpire Equipment 75
 Unbelieva-Ball 64
 Wheel Kit 22
 Wiffle Balls 65
 Windscreen 26-27
 Base Pads, Volleyball 228
 Base Protector Pads 194, 199

Basketball 92-114
 Backboards 102-103
 Ball Racks 114, 334-335
 Basketballs 92-97, 341-342
 Coaching Boards 110
 Court Chairs 108-109
 Court Stencil 112
 Goals/Rims 104-105
 Gooseneck Systems 99
 Nets 106
 Outdoor Systems 98-99
 Padding 98-99, 107
 Rebounders 112
 Rock Basketballs, The 94-95
 Scoreboards 316-319, 325-326
 Scorer's Tables 111
 Scorebook 110
 Shooting Machine 111
 Storage 114, 334-337
 Systems 98-101
 Uniforms 115-117

Bean Bags 353
 Baseball/Softball 88
 Flag 150-151
 Football 131
 Weight Lifting 236

Bench Press Machine (Selectorized) 244-245
 Benches (Players) 4-5
 Benches (Fitness) 238
 Big Bubba Pro Batting Cage 19
 Bike Racks 315
 Billiard Tables & Accessories 304-305
 Binder, Glovers 82
 Bingo 308
 Birdies, Badminton 194
 Bleachers 6-15
 Blocking Dummies 125-127
 Blood Pressure Monitor 275
 Board Games/Table Games 307-309
 Bocce 348
 Body Composition Analyzer/Scale 275-276
 Body Fat Analyzer 275-276
 BOSU 262
 Boundry Markers 190
 Boundary Netting 29, 173
 Bowling 346
 Boxing Bags 285-287
 Boxing Gloves 285
 Brooms 42
 Bulletin Board 311
 Bumper Plates 235
 Bumper Pool 304

Cable Attachments 242
 Cable Crossover Machine 245
 Cageballs 344
 Canopies 15
 Cards

Carom Board 307
 Catcher's Equipment Bag 68-69
 Catcher's Helmets/Gear 72-74
 Catcher's Mitts 76-78
 Center Strap 185
 Chain Sets 131
 Chainman's Vests 131
 Chairs, Court 108-109
 Chalk 39, 236
 Checkers 308
 Chess 308
 Chest Press Machine (Selectorized) 244
 Chest Protectors, Baseball & Softball 72-75
 Chin & Dip Station 243, 244
 Chin/Dip/Ab Station 243, 244
 Chinning/Pull Up Bar 243, 256
 Cleat Cleaner 39
 Clocks 327

Clothing
 Baseball/Softball Uniforms 84-91
 Basketball Uniforms 115-117
 Caps & Visors 86-87, 90-91
 Football Uniforms 149
 Girdles/Sliders 143
 Jerseys, Baseball/Softball 84-86, 89
 Jerseys, Reversible 115-117
 Major & Minor League Replica Caps/
 Shirts/Jerseys/Visors 84-86
 Official's Jersey 115, 131
 Scrimmage Vests 177
 Shorts 115-117
 Socks 88
 Stirrups 88
 Umpire Shirts/Caps 75
 Volleyball Jerseys/Shorts 227

Coaching Boards
 Baseball/Softball 82
 Basketball 110
 Football 120
 Lacrosse 158
 Soccer 179
 Volleyball 227

Coaching Supplies 288-291
 Air Horns 290
 Coaching Boards 82, 110, 159, 179, 227
 Coolers 155, 157
 Inflating Needles 289
 Lanyards 288
 Laundry Bags 288
 Locks 311
 Megaphones 290
 Officials Jersey 115, 133
 Scrimmage Vests 148, 179
 Towels 148, 155-156
 Two-Way Radios 291
 Water Coolers 155, 157, 188
 Whistles 288

Cold Packs 329-330
 Collars, Spring 234
 Column Pads 340
 Competition Bench 238
 Concessions 292-293
 Cones 178, 349
 Cooler Stand 154, 156, 188
 Coolers 154, 156, 188
 Cooling Systems 152-153
 Corner Flags 177, 226
 Court Chairs 108-109
 Court Marker 112, 190
 CourtClean 113
 Covers, Gym Floor 298-299
 Croquet Set 348
 Crossbars 202-203
 Cups 155, 157, 293
 Curl Bars 234
 Curl Bench 238
 Custom Netting 29

D-Man 113
 Diamond Pro Products 39
 Dip Belt 243
 Dip Station, Free-Standing 243
 Disc Golf 352
 Discus 208
 Discus Cage 210
 Discus/Shot Carrier 209
 Discus/Shotput Circles 211
 Display Cases 311
 Distance Marker 209
 Dodgeballs 345
 Dominoes 308
 Double First Bases 47-51
 Double Shot Basketball Game 307
 Down Box/Chain Set 131
 Down Boxes 131
 Drag Mats 40-41
 Dribble Specs 112
 Drinkers 152-153
 Dry Line Markers 45, 297
 Dual-Resistance Harness 266
 Duffle Bags 120, 181
 Dumbbell Racks 236
 Dumbbells 237
 Dummies, Football 125-127
 Duraskin Backboard Padding 107

Easy-Up Youth Mini Goal 101
 Ekho 215, 271, 273, 276
 Electronic Whistles 288
 Elliptical Trainers 249
 Entryway Mats 299
 Equipment Carts 114, 130, 191
 Exercise Bikes 249-251
 Exercise Mats 260-261
 Eye Goggles 196
 Eye Shields 147

E-Z Curl Bar 234
 E-Z Fold Cart 218, 229

Fence Guard 25
 Fence Stakes 30-31
 Fencing 30-32
 Fencing, Smart Poles 30-32
 Field Covers/Tarps 33-35, 132-133
 Field Distance Markers, Track 209
 Field Groomer 40-41
 Field Hockey Balls 160
 Field Hockey Equipment 160-161
 Field Markers/Strippers 45, 296-297
 Field Marking Paint 45, 296-297
 Field Marking Stick 45, 297
 Field Marking Systems 30-31, 294-295
 Field Tarp Roller 33
 First Aid Kits & Supplies 330
 Fitness Bands 293
 Fitness Cart 258, 260, 264

Fitness Equipment 234-270
 Abwheel 256
 Aerobic Steps 264
 Benches 238
 Bikes 250-251
 Body Bars 264
 Body Fat Analyzer 275-277
 Elliptical Trainers 249
 Exercise Mats 260-261
 Foam Plyo Boxes 263
 Foam Rollers 261
 Heart Rate Monitors 271, 275
 Mat Cleaner 232, 281, 332
 Medicine Balls 253
 Pedometers 272-273
 Pilates Equipment 258-262
 Plyometric Platforms 263
 Scales 275-277
 Skinfold Caliper 275
 Speed Trainers 266-267
 Stability Balls/Carts 258-259
 Stairclimbers/Steppers 249
 Step Carts 264
 Treadmills 248
 Weight Room Flooring 246-247

Fitness Mats 260-261
 Fitness Rings 254
 Fitness Step Cart 264
 Flack Vest 142

Flag Football
 Flag-A-Tag Belts 150
 Flag-A-Tag Gamebook 150
 Flag Football Ball Spotter 151
 Triple Threat Belts 151

Flat Bench 238
 Flexibility Testing 274
 Flex-I-Wrap 329

Bid #ESCJ 17/18-31

Educational Services Commission of New Jersey

Athletic Equipment & Supplies

Floor Hockey Cart 356
 Floor Hockey Equipment 356
 Floor Marking Tape/Applicator 225
 Flooring, Exercise/Weight Room 246-247
 Flying Discs/Saucers 352-353
 Foam Balls 192, 344-345
 Foolsball Tables/Accessories 303
Football 118-149
 Balls 118-120, 341-344
 Belts 149
 Cooling Systems 152-153
 Down Indicators & Chain Sets 131
 Dummies & Shields 125-127
 Flag Football 150-151
 Gatorade 154-155
 Gear Pro-Tec 136-143
 Girdles 143
 Goalposts/Pads 134-135
 Helmet Carts 145
 Helmet Accessories 146
 Hydration 152-157
 Jerseys 149
 Kicking Cages 123
 Mouthguards 147
 Officials Equipment 131
 Pant Pads 142, 144
 Pants 149
 Passing Machine 129
 Scoreboards, Play Clocks & Timers 320-321
 Shoulder Pad Racks 145
 Shoulder Pads 136-141
 Sideline Markers, Pylons 130
 Sideline Protectors 132-133
 Sleds 126, 128-129
 Stat Book 120
 Tackle Wheels 125
 Team Drinkers 152-153
 Wristcoaches 148
 Football/Soccer Combo Goal 135, 167
FUNNETS Goals 176
Futsal
 Balls 164-165
 Goals 172
 Game Clock 316-327
 Game Cones 178, 349
 Game Standards, Volleyball 228
 Game Table, Flip Table 306
 Game Tables 300-307
 Gatorade 154-155
 Gear Pro-Tec 136-143
 Girdles 143
 Girdle Inserts 142, 144
Gloves
 Baseball/Softball 76-78
 Boxing 285
 Field Hockey 161
 Goalie

Weight Training/Workout 236
Goggles
 Field Hockey 161
 Racquet Ball/Squash 196
Goals
 Basketball 104-105
 Easy-Up Youth Mini Goal 101
 Field Hockey 160
 Floor/Street Hockey 356
 Football/Soccer Combo 137, 167
 Futsal 172
 Frisbee Golf 352
 Lacrosse Goals 158-159
 Soccer 167-171, 186-188, 356
 Grass Protectors 33-35, 132-133
 Grate Covers/Guards 38
 Grills 314
 Ground Anchors, Baseball 48, 50-51
 Ground Sleeves 134-135, 165, 182, 220-221
 Gym Chalk 236, 284
 Gym Floor Covers 298-299
 Gym Flooring 298-299
 Gym Wipes Buckets 332
 Gymnastics 284
 Hack Squat Machine 241
 Handball 196
 Headbands, Tennis Net 185
 Headgear, Wrestling 233
 Headset, Coaches 291
 Heart Rate Monitors 271, 275
 Heat Index Warning System 156
 Heavy Bags 287
 Heavy Basketballs 97-113
 Helmet Caddy 83
 Helmet Covers 147
 Helmet Hardware 146
 Helmet Inflator 146
 Helmet Rack 145
 High Jump Pits/Standards 200-202
 Hip Pads, Football 144
 Hitting Mats, Baseball/Softball 37
 Hitting Trainer 79
 Hockey Equipment, Floor/Street 356
 Home Plates 46, 48, 50-51
 Hoops 353
 Hoppers 346
 Horseshoes 348
 Hoses/Accessories 44
 Huddle Zone Special Teams Mat 132
 Hurdle Carts 206
 Hurdles 206-207
Hydration 152-157
 Coolers 155, 157
 Cups 155, 157
 Gatorade 154-155
 Sports Cool 152-153

Water Bottles 154-155
 I-Beam Pads 338-340
 Ice Bags 329
 Ice Chest 155, 157
 Incline Bench 238
 Indoor Bleachers 6-7, 10
 Inflating Needles 289
 Inflators 289, 344
 Jerseys, Baseball 84-86, 89
 Jox Box 38
 Judges Stand, Track 213
 Judges Stands/Pads, Volleyball 222, 224
 Juggling 355
 Jump & Reach Board 274
 Jump Rope Racks 347
 Jump Ropes 265, 347
 Kettlebells 252
 Kicking Cages 123
 Kicking Tees 121
 Knee Braces 328
 Knee Pads, Football 142, 144
 Knee Pads, Volleyball 227
Lacrosse 158-159
 Balls 159
 Heads/Sticks 160, 354
 Goals 158-159
 Scoreboards 325
 Ladder Toss Game 355
 Lanyards 288
 Lap Counter 213
 Lat Pull Machine (Plate Load) 242
 Laundry Bags 288
 Laundry Belts 288
 Leg Extension/Leg Curl Machine (Plate Load) 241
 Leg Guards, Baseball/Softball 72-74
 Leg Press (Plate Load) 241
 Lifting Belts 236
 Lifting Gloves 236
 Lifting Straps 236
 Lightning/Storm Detector 54, 156
 Lineman Chutes 124
 Lineman Splits Marker 124-125
 Line-Mate Field Marking Systems 294-295
 Linesman Flags 179, 226
 Line-Up Cards 82
 Line-Up/Field Boards 82, 110, 120, 179, 227
 Lockers & Locks 310-311
 Low Rise Bleachers 6
 Low Row Machine (Selectorized) 244-245
 Low-Profile Cones 178, 349
 Major & Minor League Replica Caps/
 Shirts/Jerseys/Visors 84-86
 Marking Dust 39

Mat Cleaner 232, 332
 Mat Tape 232, 281
 Mat Truck/Transporter 232, 281
Mats
 Bonded Foam 278
 Carpet/Foam Floor 283
 Carts 281
 Column Pads 340
 Custom 338-340
 Downhill 284
 Drag Mats 40-41
 Entryway Mats 299
 EnviroSafe 282
 Exercise 260-261
 Expando 280-281
 Fitness 260-261
 Gymnastic/Tumbling 278-284
 Hitting, Baseball/Softball 37
 Incline Mats 284
 Landing Mats 283
 Pitching 52
 Rainbow Mat 280
 Sideline Protective Mat 132-133
 Stage/Wall Pads 338-340
 Tape 232, 281
 Ultimat 279
 Walkway 298
 Wall Pads 338-340
 Yoga 260-261
 Measuring Tapes 212
 Measuring Wheels 212
 Medicine Balls & Accessories 253, 255
 Megaphones 290
 Mini & Maxi-Net Systems 191
 Mission Athlete Care 332
 Mound & Base Covers 33-35
 Mound Slope Gauge 43
 Mouth Guards 147
 Multi Bench 238
 Multi-Fit System 244-245
 Multi-Game Boards 307
 Multisport Tabletop Scoreboard 229, 232, 317
 Multi-Station Machines 244-245
 Neck Machine 242
 Net Setter Chain 227
Nets
 Backstop Replacement Net 29
 Badminton 194
 Baseball/Softball Nets 16, 18, 19, 21-24, 29
 Baseball/Softball Protectors 22-23
 Basketball 106
 Batting Cage Nets 16, 18-19, 21
 Boundary 172
 Field Hockey 160
 Floor Hockey 356
 Funnets® 176
 Extended to 5/8/21 158-159

Bid #ESCNJ 17/18-31

Educational Services Commission of New Jersey

Athletic Equipment & Supplies

Mini & Maxi-Net Systems 191
 Passing Drill Net 122
 Soccer 166
 Table Tennis 302
 Tennis 182-183
 Volleyball 220-222, 224-225
 Wallyball 226
 Official's Jersey 131
 Official's Penalty Flag 131
 Olympic Bar Holder 234
 Olympic Plate Holder 235
 Olympic Style Bars 234
 Olympic-Style Weight Sets 235
 Outdoor Basketball Units 98-99
 Outdoor Benches & Tables 312-315

 PA System 290-291
 Padding, Backstop 28
 Paddles, Ping Pong 302
 Paint, Field Marking 45, 295
 Paint, Tennis Court 190
 Pants, Baseball 88-89
 Parachutes 346
 Park Benches 312-315
 Park Equipment 312-315
 Passing Drill Net 122
 Pedometers 272-273
 Pennant Streamers 212, 333, 349
 Performance Indicators, Track 213
 Physical Education 341-357
 Pickle Ball 191, 196, 350-351
 Picnic Tables 312-314
 Pilates Equipment 261
 Pillo Hockey/Pillo Polo 357
 Ping Pong 300-302
 Pit Covers 198-201, 213
 Pitch Counter 54
 Pitcher Practice Screen 22-23, 80-81
 Pitchers Mounds 52-53
 Pitchers Plate 46
 Pitchers Rubbers 46-51
 Pitching Machines 55
 Pitching Target 80
 Plate Brush 75
 Plates, Weight 235
 Player's Benches 4-5
 Playground Balls 343
 Playground Basketball Posts 99
 Playground Carts 336-337
 Playing Cards 308
 Plyometric Platforms 263
 Pocket Golf 307
 Pole Vault Equipment 198-199, 202-204
 Poly Cap 25
 Pool Tables & Accessories 304-305
 Pop Up Nets 81, 175
 Portable Backstops 24
 Portable Basketball

Portable Cooling System 152
 Portable Pitching Screen/Nets 22-23
 Portable Tennis System 185, 191
 Possession Indicators 111, 326
 Post Pads 98-99, 134, 168
 Power Bench 238
 Power Lift Platform 237
 Power Racks 239-240
 Pre Wrap 331
 Protective Screens/Baseball & Softball 22-23, 81
 Protector Nets 22-23, 81
 PUGG Goals 175
 Pull Up Bars 256
 Pulsemeter 275
 Push-Up Tester 274
 Pylons 130, 333

 Quadpods 37
 Quick Feet Agility Trainer 268-269
 Quik Shade Canopies 15

 Race Clock 213
 Racket Caddy 191
 Racks, Dumbbell 236
 Racks, Medicine Ball 255
 Racquetball 197
Racquets
 Badminton 195
 Paddleball 196
 Racquetball 197
 Squash 196
 Tennis 193
 Radio, Coaches 291
 Rakes 43
 RAZOR Shoulder Pads 136-137
 RampShot 348
 Reaction Ball 268
 Recumbent Bikes 248, 250
 Relay Batons 205
 Resistance Tubes/Bands 254, 257
Reversible Jerseys
 Basketball 115-117
 Rib Protector 142
 Ricochet Cushion 16, 18-19
 Rims 104-105
 Rock Basketballs, The 94-95
 Rol Dri Sponge Rollers 184
Ropes
 Fitness Power/Battling Ropes 265
Jump Ropes 265, 347
 Tug-O-War 346
 Rosin Bags 54
 Runner Mats 298
 Running Ropes 124, 269
 Runway, Rollout 213

 Safeoam Padding 18
 Safety Ratchet, Tennis 182
 Sandbags 33, 166

Scales 232, 276-277
 Scoop Ball 354
 Scooter Boards 353
 Scoreboards 316-327
Scorebooks
 Baseball/Softball 82
 Basketball 110
 Field Hockey 161
 Football 120
 Lacrosse 158
 Soccer 179
 Tennis 190
 Track 213
 Volleyball 227
 Wrestling 232
 Scoring Tables, Basketball 111
 Screens, Ball Park 21-23, 29
 Scrimmage Vests 148, 179
 Shade Canopies 15
 Shields 126, 147
 Shin Guards 179
 Shiver Pads 126
 Shooter Ring 113
 Shooting Machine-Basketball 111
 Shot Clocks 317, 319
 Shot Puts 209
 Shot/Disc Carrier 209
 Shot/Disc Circles 211
 Shotput Toe Board 211
 Shoulder Pad Rack 145
 Shoulder Pads & Accessories 134-140, 146
 Shovels 43
 Shuffleboard 303, 348
 Shuttlecocks 194
 Sideline Kits 146
 Sideline Markers 130
 Sideline Protective Mat 132-133
 Sign Stands 333
 Sit Up Board 243
 Skinfold Caliper 275
 SKLZ 112-113, 121-123, 178, 264, 266-270
 Skyscan 54, 156
 Sleds, Football 126, 128-129
 Slipp-Nott 110
 Smith Machine 240
Soccer 162-181
 Bags 181
 Balls 162-165
 Bench 179
 Cones 178
 Corner Flags 177
 Funnets® 176
 Goalie Gloves 180
 Goal Accessories 166
 Goals (Club/Competition) 167-183
 Goals (Practice/Training) 172-176, 178
 Headgear 181
 Nets 166

Referee Supplies 179
 Scoreboards 324-325
 Scorebook 179
 Scrimmage Vests 179
 Shin Guards 180
 Socks 88
 Softballs 60-66
 Speed Bags 286
 Speed Chute 266
 Speed Trainers 266-267
 SpeedSac 267
 SpikeBall 352
 Spike Trainer, Volleyball 226
 Spikes, Track 205
 Sportpanel Fencing 32
 Sports Cool 152-153
Sports Medicine 328-332
 Ankle Braces 328
 Athletic & Trainers Tape 331
 Bandages 330-331
 Cold Packs 329
 Disinfectants 332
 First Aid Kits & Supplies 330
 Ice Therapy Braces 329
 Knee Braces 328
 Sports Wristband 115, 148
 Spots 349
 Spring Boards 284
 Spring Collars 234
 Squash 196
 Squat Rack 239-240
 Stage Pads 340
 Stairclimbers/Steppers 249
 Standard Bench 238
 Starting Block Cart 205
 Starting Blocks 205
Stencils
 Basketball Court 112
 Football Field 296
 Stopwatches 214-215, 289
Storage & Transport
 Ball Carts 114, 334-335, 337
 Ball Equipment Bags 120, 181, 229
 Ball Hoppers 189
 Ball Lockers/Ball Carriers
 114, 120, 229, 334-335
 Baseball/Softball Equipment Bags,
 Totes, Caddies 66, 68-69, 74
 Bat Rack, Fence Mounted 83
 Duffle Bags 68-69, 74, 120, 181
 Dugout Organizer Rack 83
 E-Z Fold Cart 218, 229, 335
 Field Tarp Roller 33
 Fitness Carts 264
 Fitness Step Cart 264
 Floor/Street Hockey Transporter 356
 Football Equipment Bag 120
 Football Helmet Cart 145

Bid #ESCNJ 17/18-31

Educational Services Commission of New Jersey

Athletic Equipment & Supplies

Gym Floor Cover Mobile Storage Racks 298
 Helmet Rack/Tree 83
 Hurdle Carts 206
 Jump Rope Racks 337,347
 Laundry Bags 288
 Laundry Carts 337
 Mat Truck/Transporter 281
 Medicine Ball Racks 255
 Pit Transport Cart 202
 Playground Carts 336-337
 Racket Caddy 191
 Recess Rack 337
 Scooterboards 336
 Shot/Discus Carrier 209
 Shot/Discus Cart 209
 Shoulder Pad Rack 145
 Starting Block Cart 205
 Tennis Ball Retrievers 189
 Volleyball Carry Bags 229
 Volleyball Carts 218, 222, 229, 335
 Storm Detector 54, 156
 Streamers & Posts 333, 349
 Street Hockey 356
 String Winder 39
 Swing Seats 355

Table Games/Board Games 307-309
 Table Tennis 300-302
 Table Top Games 307
 Table Top Scoreboard 227, 232, 317, 326
 Take Off Boards 212
 Tape (Athletic) 331
 Tape, Floor Marking 225
 Tape, Mat 232, 281
 Targets, Archery 358
 Team Walkers 346
 Teamwork Trekkers 346
 Template, Batters Box 45

Tennis
 Ball Machines 189
 Balls 192
 Bench 184
 Carts 189, 191
 Nets 182-183, 191
 Paint 190
 Portable System 194
 Posts 182
 Quickstart, 10 & Under 191-192
 Racquets 193
 Rol Dri 184
 Scorekeeper 188
 Tidi-Court 188
 Windscreen 186-187
 Tetherball 355
 Thigh Pads, Football 142, 144
 Tie Wraps 25
 Timers/Clocks 321, 327
 Tip-N-Roll Bleachers 355

Tooth Protectors 147
 Topplesball 357
 Toss Back Training Aid 80, 112
 Towels 155-156

Track and Field
 Batons 205
 Cages 210
 Circles 211
 Crossbars 202-203
 Discs 208
 Distance Markers 209
 High Jump Pits 200-202
 Hurdle Carts 206
 Hurdles 206-207
 Implement Cart 209
 Measuring Wheels 212
 Pennant Streamers 212
 Pit Cart 202
 Pole Vault Pits 198-199
 Scorebook 213
 Shots 209
 Spikes 205
 Standards 202-203
 Starting Blocks 204
 Stop Watches/Timers 213-215
 Take Off/Toe Boards 212
 Tape Measures 212
 Vaulting Boxes 212
 Track Timing Clipboard 213
 Track Protectors 132
 Traffic Safety Vest 333
 Trainers Tape 331
 Training Multi-Purpose Sleds 267
 Training Platforms 239
 Training Sled 126, 128-129, 267
 Transportable Bleachers 15
 Trash Receptacle 315
 Treadmills 248
 Trophy Cases 311
 Tug-O-War Ropes 346
 Twine 29, 39, 185
 Two-Way Radio 291

Umpire Equipment 75

Uniforms
 Baseball/Softball 84-89
 Basketball 115-117
 Football 148-149
 Volleyball 227
 Urban Rebounder 264

Vault Box/Collar 203
 Vaulting Boards 284
 Vests 148, 179, 268
 Video Display/Scoreboard 319

Volleyball 216-230
 Antenna 227
 Bags 229
 Balls 216-219, 342

Base Pad 228
 Boundary Markers 230
 Bungee Blocker 226
 Carts 218, 222, 226, 229
 Judges Stand 222-252
 Knee Pads 227
 Linesman Flags 226
 Net Setter Chain 227
 Net Tension Straps 227
 Nets 220-221, 223-225
 Pass Rite 226
 Pole Pads 222-224, 228
 Scorebook 227
 Scorekeeper 229
 Outdoor Sets 230
 Spike Trainer 226
 Standards 220-221, 223-224, 228
 Storage Racks 225
 Systems 220-221, 223-224
 Target Challenger 226
 Tutor Machine 226
 Uniforms 227
 Volleyball Pal 226

Walkway Runner Mats 298
 Wall Pads 338-340
 Wall Suction Cups, Wallyball 226
 Wallyball & Accessories 226
 Warning Cards & Wallet, Soccer 179
 Washer Toss Game 348
 Water Bottles & Carrier 154-155
 Water Broom 184
 Water Coolers 155, 157, 188
 Water Removers 42, 184
 Weather Cover 198-201
 Weight Collars 234

Weight Equipment 234-270
 Abdominal Exerciser 258
 Back & Abdominal Exercise Bench 243
 Bar Wrap Pads 234
 Barbells 234-235
 Belts 236
 Bumper Plates 235
 Cable Attachments 242
 Cable Crossover Machine 245
 Chalk 236
 Chin & Dip Station 243, 246
 Chin/Dip/Ab Station 243, 246
 Competition Bench 238
 Curl Bars 234
 Curl Bench 238
 Decline Bench 238
 Dumbbell Racks 237
 Dumbbells 237
 Flat Bench 238
 Gloves 236
 Glute/Ham Bench 241

Incline Bench 238
 Incline Rower (Plate Load) 242
 Incline Support Bench 238
 Lat Pull & Row Machines 242, 244-245
 Leg Extension/Leg Curl Machines 241, 245
 Multi Bench 238
 Multi-Rack 239-240
 Multi-Station Machines 244-245
 Neck Machine 242
 Olympic Style Bars 234-235
 Olympic-Style Weight Sets 235
 Power Bench 238
 Power Lift Platform 237
 Power Racks 240
 Power Ram Sled Hack-Machine/Leg Press 241
 Shoulder Press Machine (Selectorized) 244
 Sit Up Board 243
 Smith Machine 240
 Spring Collars 234
 Squat Rack 240
 Standard Bench 238
 Weight Plates 235
 Weightroom Racks 239-240
 Weight Lifting Chains 234
 Weight Lifting Resistance Bands 234
 Weighted Jump Ropes 265
 Weightroom Flooring 246-247
 Weightroom Racks 239-240
 Whistles 288
 Wiffle Ball 65
 Windscreen & Accessories 26-27, 186-187
 Workout Steps 264
 Wrestling Equipment/Mats 231
 Wrist Roller 234
 Wristcoaches 148

Yoga Mats 260-261

Z-Balls 268
 Z-Cool 138-139, 141-143



BASEBALL/SOFTBALL

BASKETBALL

FOOTBALL

HYDRATION

LACROSSE

FIELD HOCKEY

TENNIS

RACQUETBALL

BADMINTON

SOCCER

TRACK & FIELD

VOLLEYBALL

WRESTLING

WEIGHT LIFTING

CARDIO

FLOORING

CORE

SPEED/AGILITY

ASSESSMENT

MATS

GYMNASTICS

BOXING

COACHING

CONCESSIONS

FIELD MARKING

FLOOR COVERS

GAME TABLES

LOCKS & LOCKERS

BENCHES & BLEACHERS

PARKS

SCOREBOARDS

SPORTS MEDICINE

TRAFFIC SAFETY

STORAGE

WALL PADS

PHYSICAL EDUCATION